



Technology and Quality

MORE THAN 50 YEARS' EXPERIENCE

CATALOGUE 2023

POLYLUX®

Technology and Quality

MORE THAN 50 YEARS' EXPERIENCE

We at **POLYLUX** help our customers improve their premises by providing them with high quality, reliable, safe products and solutions that can be adapted to all their needs for **diverse industrial applications**.

POLYLUX has extensive experience in the electrical sector, providing tailored solutions and implementing improvements to its products in order to adapt to market demands.

Our premises of over 20,000 m² include a production area of 12,000 m², an office area of 2,000 m² and the rest is used for services.

What makes our products different from others? Continuous improvement and quality.



Dip varnishing. + **Drying in a high compactation furnace**

These two processes prevent noise and vibrations in the operation of our products. This achieves increased isolation and additional protection against damp.

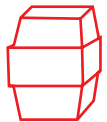

Flame retardant resin encapsulation.

This process gives our products high resistance to thermal contrasts and complies with the UL94 V0 plastics flammability standard.



Magnetic cores.

We use magnetic cores with different properties and construction formats to achieve high efficiency.



Flexibility in the final product construction.

We adapt to all installation needs and design enclosures with different IP grades. Certified IP23 and IP65 enclosures.



Product testing.

Automatic checks and tests on **ALL** the products, in accordance with the standards.



Customer focus.

Technical support team that offers advice on product installation and maintenance.



POLYLUX manufactures transformers for general use and for the most demanding applications such as the petrochemical, railway, marine, hospital, renewable energy and pool sectors, among others. Our innovative range of harmonic filters and compensators provides a unique and very effective solution to harmonic problems in office and industrial installations. In addition, **POLYLUX** has a stabilised and non-stabilised power supply unit range for all types of direct current applications.

All our transformers have welded terminals, which brings greater reliability and connection stability. On the other hand, our dip varnished finishes provide protection against corrosive environments, greater compactation, noise reduction and an increase in service life and electrical isolation. **POLYLUX** specialises in encapsulation resins, adding many technical advantages to its products.

Strict quality control and 100% checking of products.

The products manufactured by **POLYLUX** are used for voltage conversion, safety of installations and electrical energy quality. Our goal is to provide an extensive range of products in this field in order to offer our customers the most complete solutions. With **more than 50 years' experience** we provide a wide variety of transformers with powers ranging from 40 VA to 1000 kVA.

POLYLUX is aware that the implementation of energy saving solutions will only be effective if they are economically profitable for the customer and the end user. All our products are manufactured and checked in accordance with international standards and strict parameters.

We apply continuous innovation as a basis for adapting to new market demands and in order to continue to be a leading firm in our sector. Within this context, we continuously improve our product range and develop ground-breaking products that offer our customers new solutions.



Table of contents

		Series	Page	
Single-phase control manoeuvre and isolation transformers				
According to model from the same series	Input: 230-400 V or 230-400-460 V Output: 12-24, 24-48 or 115-230 V	P	6	
		Q	12	
		N	18	
Single-phase ultra-isolation transformers				
	Input: 230 V Output: 230 V	With one or three screens on request	PTU	24
			QTU	29
Single-phase transformers for spotlights in pools and gardens				
For LED spotlights.	Input: 230 V Output: 12 V	PIL	34	
		QIL	37	
For halogen lamps.	Input: 230 V Output: with three settings, depending on the distance from the spotlight to obtain 12 V.	PIP	40	
		PIQ	44	
		PIN	48	
		PIPZ	52	
IP54-rated encapsulated single-phase transformers				
Depending on model	Input: 230-400 V or 230-400-460 V	Output: 12-24-115-230 V	IP	55
Security PC	Input: 230 V	Output: 12 V (TPA) or 24 V (TPB)	TP	59
Transformers for voltage measuring equipment				
Individual	Input: 100 to 690 V or 100 V / $\sqrt{3}$ to 690 V / $\sqrt{3}$ Output: 100 to 690 V or 100 V / $\sqrt{3}$ to 690 V / $\sqrt{3}$	PTM	61	
		QTM	64	
		TM	67	
Kit with three units			TMT	70
Current transformers				
Primary winding	Input: 10 to 25 A	Output: 5 A	TIB	73
Primary pass-through	Input: 40 to 500 A	Output: 5 A	TIP	74
Open core (SPLIT)	Input: 400 to 1500 A	Output: 5 A	TIN	75
Accessories for isolation and temperature control				
	Temperature control unit		CTM4	76
	Remote monitor for up to 12 viewers VA40-485		MR12	78
	Isolation monitor and RS485 communication bus		VA40	79
	Panel indicator light		CR5	82
	Current transformer		TI1	83
Rectifier transformers				
Single-phase	Input: 230 V (AC)	Output: 12, 24 or 48 V (DC)	No filter TR	84
			With filter TRF	88
Three-phase	Input: 400 V (AC)	Output: 12, 24 or 48 V (DC)	TRT	92
Switched-mode power supply units				
Single-phase	Input: 110-240 V (AC)	Output: 12 V (FCPB)(DC) and 24 V (FCP)(DC)	FCP	96
Three-phase	Input: 370-430 V (AC)	Output: 24 V (DC)	FCPT	97
Transformers for medical electrical installations				
Single-phase	Input: 230 V	Output: 230 V	TH	98
	Input: 230 \pm 5% V	Output: 24-25-26-27 V	TLQ	102
Three-phase	Input: 400 V	Output: 230 V	TTH	105
Three-phase transformers for harmonic networks				
	Input: 400 V	Output: 400 V + neutral	TTFK	109

Table of contents

		Series	Page	
Harmonic compensators				
For offices	Network: 400 V	CD	116	
For industries	Network: 400 V	CF	123	
	Solutions for office installations		128	
	Solutions for industrial installations		130	
Harmonic filtering inductances				
Single-phase	Network: 220 V to 260 V	QR	131	
	Network: 220 V to 260 V	R	134	
Three-phase	Network: 380 V to 460 V	RTLX	136	
		RTL	139	
Harmonic filtering inductances in three-phase lines at the converter output				
	Network: 400 V	RTOX	142	
	Network: 400 V for converter-motor distances > 30 metres	FTOX	145	
Three-phase rejection inductances for capacitor batteries				
	Network: 400 V 50 Hz	Filter factor: 7%	RTFX 148	
Isolation transformers				
Single-phase	Input: 15-0-15-230-400 V	Output: 230 V	PXR 151	
	Input: 230 V	Output: 230 V	TK 154	
	Input: 230 V	Output: 230 V	TK5IN 160	
Three-phase	Input: 400 V	Output: 400 V + neutral	TT 166	
	Input: 230 V	Output: 400 V + neutral	TTU 174	
	Input: 400 V	Output: 230 V + neutral	TTD 181	
Transformers for solar inverters				
	Input: 800 V + neutral	Output: 400 V + neutral	TTF 188	
Three to single phase isolation transformers				
	Input: 400 V (three-phase)	Output: 230 V (single-phase)	TTK 195	
Ecological three-phase isolation transformers				
	Input: 400 V	Output: 400 V + neutral	TTG 202	
Reversible autotransformers				
Single-phase	Voltages: 400 / 230 V		PAU 209	
			QAU 212	
	Voltages: 220 / 125 V		AUR 215	
Three-phase	Voltages: 400 / 230 V		AUT 217	
Three-phase auto transformers for creating artificial neutral				
	Input: 400 V	Output: Neutral ZIG-ZAG connection	AUTN 224	
Three-phase auto transformers for solar inverters				
	Input: 800 V	Output: 400 V	AUTF 231	
Voltage converters				
Single-phase	Input: 230 V	Output: from 0 to 250 V	Manual adjustment	EV 238
			Motorised adjustment	EVM 239
Three-phase	Input: 400 V	Output: from 0 to 440 V	Manual adjustment	EVT 240
			Motorised adjustment	EVTM 241
Voltage stabilisers				
Single-phase	Input: 230 V ± 15 %	Output: 230 V	VK 242	
Three-phase	Input: 400 V ± 15 %	Output: 400 V	VTF 244	
Accessories				
	Customised fabrications		246	
	Protection ratings, benefits of resin encapsulation and symbols		248	
	Appendix:		249	
	Insulators and connection groups		250	
	Table for the selection of conductors and protections for low power single-phase transformers		251	
	Table for the selection of protections for high power single-phase and three-phase transformers		252	



P SERIES

Control manoeuvre and isolation

Definition and applications

Our P series equipment has a robust, modern design and is perfect for continuous operation in supplying industrial, tertiary or residential installations and machinery. Due to its design, it has an IP20 rating that prevents direct electrical contact and protects windings perfectly.

Its main applications are:

- Isolation of circuits, with the ability to increase or reduce the output voltage.
- Changing the neutral system of installations, with the ability to change from a two-phase network to a single one or vice versa (this case entails creating an artificial neutral).
- In installations with a determined level of electrical noise, the user of the transformer helps improve the quality of the electrical network in secondary.
- Installations that require a safety voltage (<50 V).
- The ability to isolation more sensitive systems in a control panel.
- Obtaining different control and manoeuvre voltages in an electrical panel.

Up to 2500 VA.



- Technical polymer box.
- UL 94 V-0 flame retardant material.
- Protective terminal cover to prevent direct contact.
- Ventilation ducts at the top and along the perimeter.
- Feature label with all the connection and protection instructions.

From 3150 VA.



- Epoxy painted metal box resistant to all types of damp and corrosive atmospheres.
- Protective terminal cover to prevent direct contact.
- Ventilation ducts along the box perimeter.
- Feature label with all the connection and protection instructions.

NEW head design



- Increased wiring insulation.
- Clearer features.
- Easier connection.
- More uniform, compact and robust design.

Technical features - standard model

Power	40 VA to 5000 VA
Insulators	Class B - 130 °C
Winding	Class HC - 200 °C
Room temperature	45 °C
Frequency	50-60 Hz
Noise	≤ 45 dB
Protection rating	IP20
Cooling	ANAN
Includes	LED indicator lamp
Mounting	With screws (for all powers) Mounting on DIN 46277/3 rail (up to 250 VA)
Standards	IEC/EN/UNE-EN 61558, CE
Protection	Convertible from Class I to Class II (up to 2500 VA).
Voltage selection	Metallic bridges, included
Operation	Continuous
Test voltage	4.6 kV (1 min., 50 Hz) between primary and secondary 3.2 kV (1 min., 50 Hz) between primary and ground 2.5 kV (1 min., 50 Hz) between secondary and ground



Protection calculation

Electrical diagrams

- **Up to 100 VA**

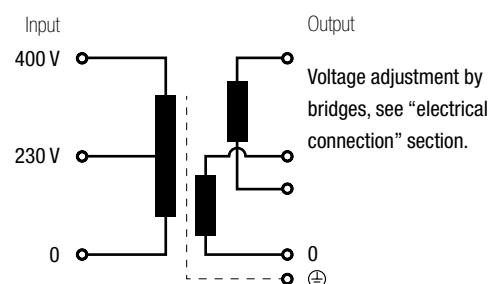

- **From 160 VA**

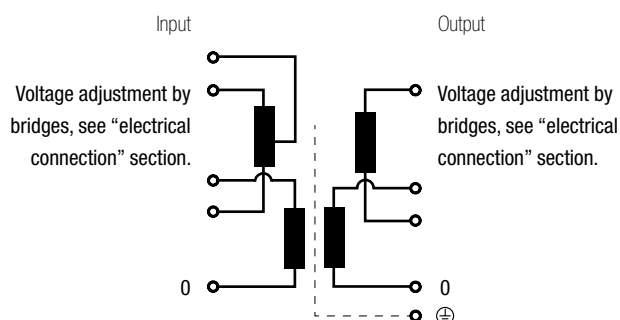



P SERIES

Control manoeuvre and isolation

Electrical connection

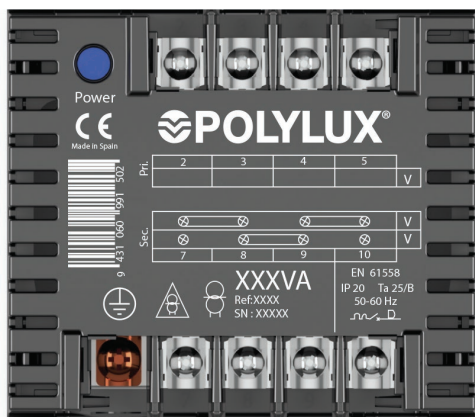

≤ 100 VA

Input:

- 230 V | Connection: 2-3
- 400 V | Connection: 2-4

Output:

- Reference PB 12 V | Connection: 7-10
- Reference PC 24 V | Bridges: 7-8 / 9-10
- Reference PD 115 V
- Reference PB 24 V | Connection: 7-10
- Reference PC 48 V | Bridges: 8-9
- Reference PD 230 V



Connection video

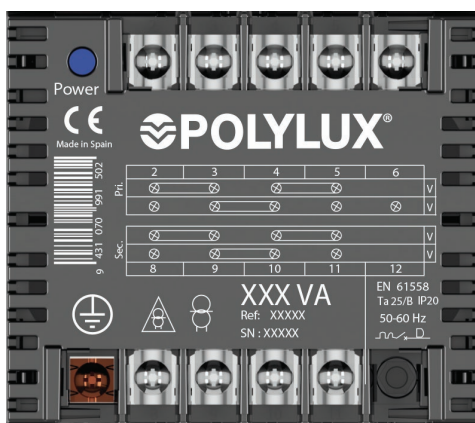

From 160 VA to 1000 VA

Input:

- 230 V | Connection: 2-5
Bridges: 2-3 / 4-5
- 400 V | Connection: 2-6
Bridges: 3-4
- 460 V | Connection: 2-5
Bridges: 3-4

Output:

- Reference PB 12 V | Connection: 8-11
- Reference PC 24 V | Bridges: 8-9 / 10-11
- Reference PD 115 V
- Reference PB 24 V | Connection: 8-11
- Reference PC 48 V | Bridges: 9-10
- Reference PD 230 V



Connection video



≥ 1250 VA

Input:

- 230 V | Connection: 1-4
Bridges: 1-2 / 3-4
- 400 V | Connection: 1-5
Bridges: 2-3
- 460 V | Connection: 1-4
Bridges: 2-3

Output:

- Reference PC 24 V | Connection: 7-10
- Reference PD 115 V | Bridges: 7-8 / 9-10
- Reference PC 48 V | Connection: 7-10
- Reference PD 230 V | Bridges: 8-9



Connection video



P SERIES

Control manoeuvre and isolation

Terminal types

Terminal blocks	Dimensions mm				Maximum tightening torque N·m	Primary		Secondary	
	A	B	C	Ø		Power VA		Power VA	
						From	To	From	To
Terminal M3	8	11	9	M3	0.5	40	100	40	100
Terminal M4	10	13.5	12	M4	1.1	160	1000	160	250
Terminal M5	15	18.5	14	M5	2.5	1250	5000	315	1000
Terminal M6	15.5	20.4	13	M6	4	-	-	1250	5000

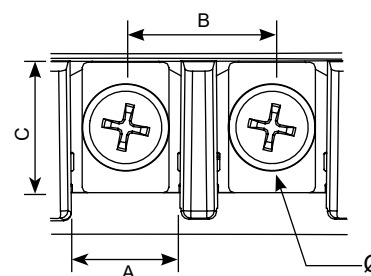

Theoretical data - standard model

Power VA	Reference	Input current A			Output current A		Input protections (A) (MCB -> D / Fuse -> aM)			Output protections (A) (MCB -> C / Fuse -> gG)	
		230 V	400 V	460 V	V1	V2	230 V	400 V	460 V	V1	V2
PB (output voltage 12 V [V1] or 24 V [V2])											
40	PB40	0.17	0.10	-	3.33	1.67	0.4 (--T)	0.2 (--T)	-	3.15	1.6
63	PB63	0.27	0.16	-	5.25	2.63	0.63 (--T)	0.315 (--T)	-	5	2.5
100	PB100	0.43	0.25	-	8.33	4.17	1 (--T)	0.5 (--T)	-	8	4
160	PB160	0.70	0.40	0.35	13.33	6.67	1.6	1	0.63	12.5	6
200	PB200	0.87	0.50	0.43	16.67	8.33	2	1	1	16	8
250	PB250	1.09	0.63	0.54	20.83	10.42	2.5	1.25	1.25	20	10
315	PB315	1.37	0.79	0.68	26.25	13.13	3.15	1.6	1.6	25	12.5
400	PB400	1.74	1.00	0.87	33.33	16.67	4	2	2	32	16
500	PB500	2.17	1.25	1.09	41.67	20.83	5	2.5	2.5	40	20
PC (output voltage 24 V [V1] or 48 V [V2])											
40	PC40	0.17	0.10	-	1.67	0.83	0.4 (--T)	0.2 (--T)	-	1.6	0.8 (--T)
63	PC63	0.27	0.16	-	2.63	1.31	0.63 (--T)	0.315 (--T)	-	2.5	1.25
100	PC100	0.43	0.25	-	4.17	2.08	1 (--T)	0.5 (--T)	-	4	2
160	PC160	0.70	0.40	0.35	6.67	3.33	1.6	1	0.63	6	3.15
200	PC200	0.87	0.50	0.43	8.33	4.17	2	1	1	8	4
250	PC250	1.09	0.63	0.54	10.42	5.21	2.5	1.25	1.25	10	5
315	PC315	1.37	0.79	0.68	13.13	6.56	3.15	1.6	1.6	12.5	6
400	PC400	1.74	1.00	0.87	16.67	8.33	4	2	2	16	8
500	PC500	2.17	1.25	1.09	20.83	10.42	5	2.5	2.5	20	10
630	PC630	2.74	1.58	1.37	26.25	13.13	6	3.15	3.15	25	12.5
800	PC800	3.48	2.00	1.74	33.33	16.67	8	4	4	32	16
1000	PC1000	4.35	2.50	2.17	41.67	20.83	10	5	5	40	20
1250	PC1250	5.43	3.13	2.72	52.08	26.04	10	6.3	5	50	25
1600	PC1600	6.96	4.00	3.48	66.67	33.33	16	8	8	63	32
2000	PC2000	8.70	5.00	4.35	83.33	41.67	20	10	10	80	40
PD (output voltage 115 V [V1] or 230 V [V2])											
40	PD40	0.17	0.10	-	0.35	0.17	0.4 (--T)	0.2 (--T)	-	0.31 (--T)	0.16 (--T)
63	PD63	0.27	0.16	-	0.55	0.27	0.63 (--T)	0.315 (--T)	-	0.5 (--T)	0.25 (--T)
100	PD100	0.43	0.25	-	0.87	0.43	1 (--T)	0.5 (--T)	-	0.8 (--T)	0.4 (--T)
160	PD160	0.70	0.40	0.35	1.39	0.70	1.6	1	0.63	1.25	0.63 (--T)
200	PD200	0.87	0.50	0.43	1.74	0.87	2	1	1	1.6	0.8 (--T)
250	PD250	1.09	0.63	0.54	2.17	1.09	2.5	1.25	1.25	2	1
315	PD315	1.37	0.79	0.68	2.74	1.37	3.15	1.6	1.6	2.5	1.25
400	PD400	1.74	1.00	0.87	3.48	1.74	4	2	2	3.15	1.6
500	PD500	2.17	1.25	1.09	4.35	2.17	5	2.5	2.5	4	2
630	PD630	2.74	1.58	1.37	5.48	2.74	6	3.15	3.15	5	2.5
800	PD800	3.48	2.00	1.74	6.96	3.48	8	4	4	6	4
1000	PD1000	4.35	2.50	2.17	8.70	4.35	10	5	5	8	4
1250	PD1250	5.43	3.13	2.72	10.87	5.43	10	6.3	5	10	5
1600	PD1600	6.96	4.00	3.48	13.91	6.96	16	8	8	12.5	6
2000	PD2000	8.70	5.00	4.35	17.39	8.70	20	10	10	16	8
2500	PD2500	10.87	6.25	5.43	21.74	10.87	25	12.5	12.5	20	10
3150	PD3150	13.70	7.88	6.85	27.39	13.70	32	16	16	25	12.5
4000	PD4000	17.39	10.00	8.70	34.78	17.39	40	20	20	32	16
5000	PD5000	21.74	12.50	10.87	43.48	21.74	50	25	25	40	20



P SERIES

Control manoeuvre and isolation

Theoretical data - standard model

Power VA	Reference	Maximum cross-section input conductor (mm ²)						Maximum cross-section output conductor (mm ²)			
		230 V		400 V		460 V		V1		V2	
		Flexible	Rigid	Flexible	Rigid	Flexible	Rigid	Flexible	Rigid	Flexible	Rigid
PB (output voltage 12 V [V1] or 24 V [V2])											
40	PB40	0.5	0.5	0.5	0.5	-	-	1	1.5	1	1.5
63	PB63	0.5	0.5	0.5	0.5	-	-	1.5	2	1	1.5
100	PB100	0.5	1	0.5	0.5	-	-	2	2.5	1.5	2
160	PB160	0.5	1	0.5	0.5	0.5	0.5	2.5	4	1.5	2
200	PB200	0.5	1	0.5	1	0.5	1	4	-	2	2.5
250	PB250	0.5	1	0.5	1	0.5	1	4	-	2.5	4
315	PB315	0.5	1	0.5	1	0.5	1	6	-	2.5	4
400	PB400	1	1.5	0.5	1	0.5	1	8	-	4	-
500	PB500	1	1.5	0.5	1	0.5	1	10	-	4	-
PC (output voltage 24 V [V1] or 48 V [V2])											
40	PC40	0.5	0.5	0.5	0.5	-	-	1	1.5	0.5	1
63	PC63	0.5	0.5	0.5	0.5	-	-	1	1.5	0.5	1
100	PC100	0.5	1	0.5	0.5	-	-	1.5	2	1	1.5
160	PC160	0.5	1	0.5	0.5	0.5	0.5	1.5	2	1	1.5
200	PC200	0.5	1	0.5	1	0.5	1	2	2.5	1.5	2
250	PC250	0.5	1	0.5	1	0.5	1	2.5	4	1.5	2
315	PC315	0.5	1	0.5	1	0.5	1	2.5	4	1.5	2
400	PC400	1	1.5	0.5	1	0.5	1	4	-	2	2.5
500	PC500	1	1.5	0.5	1	0.5	1	4	-	2.5	4
630	PC630	1	1.5	1	1.5	0.5	1	6	-	2.5	4
800	PC800	1	1.5	1	1.5	1	1.5	8	-	4	-
1000	PC1000	1.5	2	1	1.5	1	1.5	10	-	4	-
1250	PC1250	1.5	2	1	1.5	1	1.5	16	-	6	-
1600	PC1600	1.5	2	1	1.5	1	1.5	16	-	8	-
2000	PC2000	2	2.5	1.5	2	1.5	2	20	-	10	-
PD (output voltage 115 V [V1] or 230 V [V2])											
40	PD40	0.5	0.5	0.5	0.5	-	-	0.5	0.5	0.5	0.5
63	PD63	0.5	0.5	0.5	0.5	-	-	0.5	1	0.5	0.5
100	PD100	0.5	1	0.5	0.5	-	-	0.5	1	0.5	1
160	PD160	0.5	1	0.5	0.5	0.5	0.5	0.5	1	0.5	1
200	PD200	0.5	1	0.5	1	0.5	1	1	1.5	0.5	1
250	PD250	0.5	1	0.5	1	0.5	1	1	1.5	0.5	1
315	PD315	0.5	1	0.5	1	0.5	1	1	1.5	0.5	1
400	PD400	1	1.5	0.5	1	0.5	1	1	1.5	1	1.5
500	PD500	1	1.5	0.5	1	0.5	1	1.5	2	1	1.5
630	PD630	1	1.5	1	1.5	0.5	1	1.5	2	1	1.5
800	PD800	1	1.5	1	1.5	1	1.5	1.5	2	1	1.5
1000	PD1000	1.5	2	1	1.5	1	1.5	2	2.5	1.5	2
1250	PD1250	1.5	2	1	1.5	1	1.5	2.5	4	1.5	2
1600	PD1600	1.5	2	1	1.5	1	1.5	2.5	4	1.5	2
2000	PD2000	2	2.5	1.5	2	1.5	2	4	-	2	2.5
2500	PD2500	2.5	4	1.5	2	1.5	2	4	-	2.5	4
3150	PD3150	2.5	4	2	2.5	1.5	2	6	-	2.5	4
4000	PD4000	4	-	2	2.5	2	2.5	8	-	4	-
5000	PD5000	4	-	2.5	4	2.5	4	10	-	4	-



P SERIES

Control manoeuvre and isolation

Measurements

Power VA	Input voltage V	Output voltage V References			External dimensions mm			Fastening elements mm			Weight kg
		12 / 24	24 / 48	115 / 230	A	B	C	D	E	Ø	
40	230 / 400	PB40	PC40	PD40	84	101	98	88	55	5	1.1
63	230 / 400	PB63	PC63	PD63	84	101	98	88	55	5	1.3
100	230 / 400	PB100	PC100	PD100	84	101	98	88	55	5	1.6
160	230 / 400 / 460	PB160	PC160	PD160	106	123	118	110	74	5	2.3
200	230 / 400 / 460	PB200	PC200	PD200	106	123	118	110	74	5	2.8
250	230 / 400 / 460	PB250	PC250	PD250	106	123	118	110	74	5	3.6
315	230 / 400 / 460	PB315	PC315	PD315	118	138	131	121	88	6	4.1
400	230 / 400 / 460	PB400	PC400	PD400	118	138	131	121	88	6	4.8
500	230 / 400 / 460	PB500	PC500	PD500	136	162	156	145	104	6	6
630	230 / 400 / 460		PC630	PD630	136	162	156	145	104	6	7.8
800	230 / 400 / 460		PC800	PD800	136	162	156	145	104	6	8.7
1000	230 / 400 / 460		PC1000	PD1000	136	162	180	145	104	6	9.6
1250	230 / 400 / 460		PC1250	PD1250	214	225	284	195	175	7	16.6
1600	230 / 400 / 460		PC1600	PD1600	214	225	284	195	175	7	20.8
2000	230 / 400 / 460		PC2000	PD2000	214	225	284	195	175	7	25.9
2500	230 / 400 / 460			PD2500	214	225	284	195	175	7	28.7
3150	230 / 400 / 460			PD3150	247	260	349	233	223	7	36.7
4000	230 / 400 / 460			PD4000	247	260	349	233	223	7	43.5
5000	230 / 400 / 460			PD5000	247	260	349	233	223	7	56.1

Up to PB500, PC1000 and PD1000

From PC1250 to PC2000
From PD1250 to PD2500

From PD3150

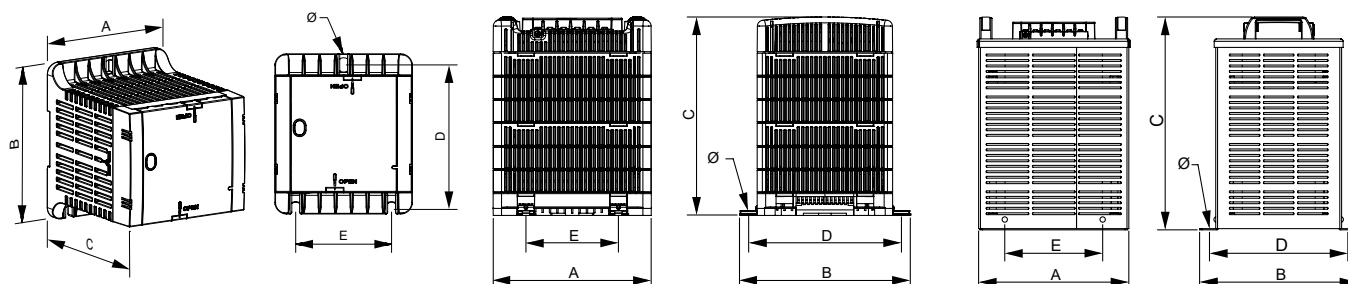

On-request manufacturing options (please see prices)

Power	From 25 VA to 5000 VA
Voltage	From 6 V to 1100 V
Shields	Primary / secondary, primary / ground and secondary / ground

Creating neutral

To perform this procedure: use a single-phase transformer with the appropriate power and connect it to primary with both phases and create a bridge at the output between one of the output phases and ground. This line will act as neutral from this moment.

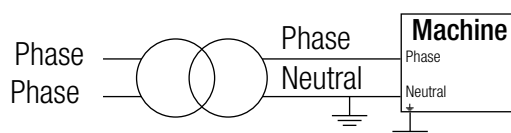



P SERIES

Control manoeuvre and isolation

Feature plate structure

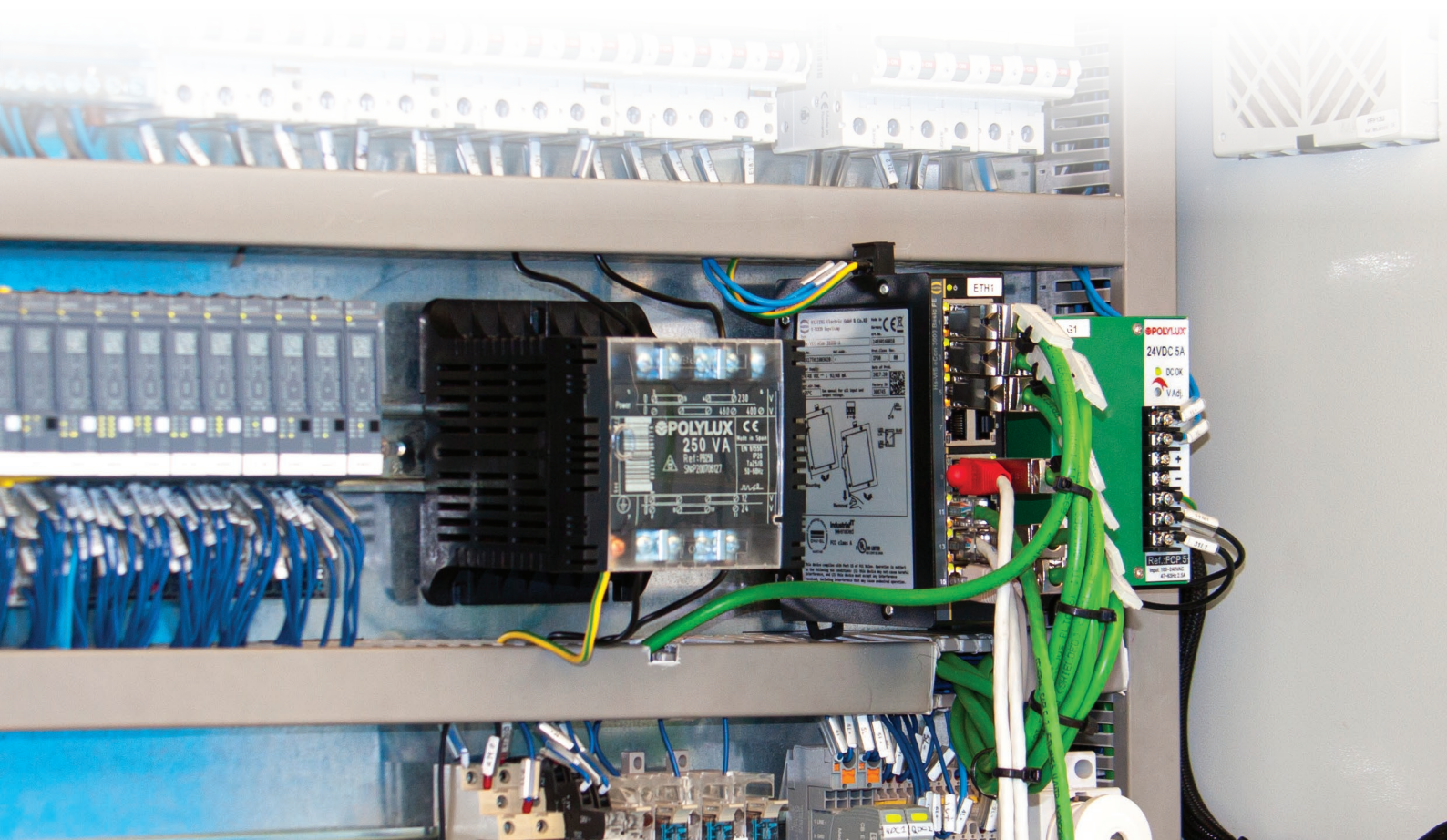
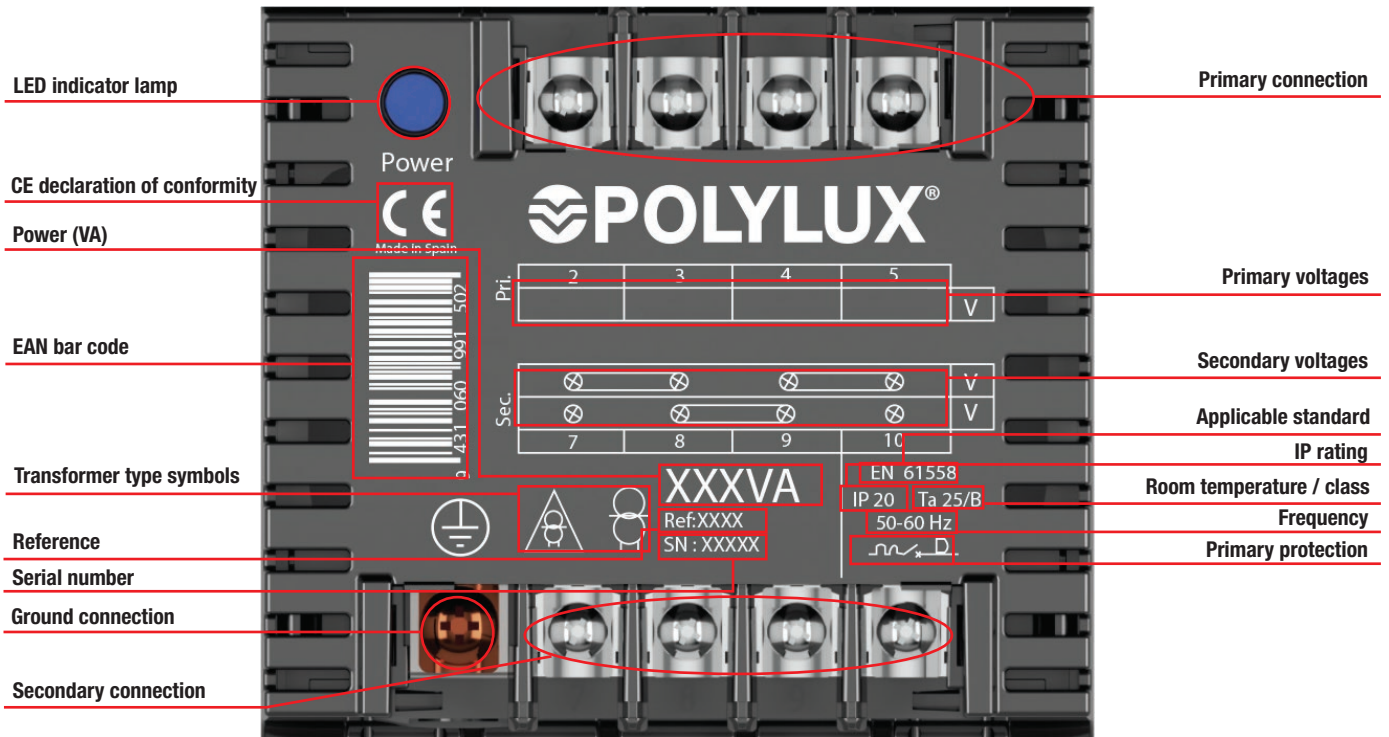

Q SERIES

Encapsulated control, manoeuvre and isolation



Up to 1000 VA

- Technical polymer box.
- UL 94 V-0 flame retardant material.
- V-0 flame retardant resin encapsulation.
- Protective terminal cover to prevent direct contact.
- Feature label with all the connection and protection instructions.



From 1250 VA

- Completely encapsulated in flame retardant resin V-0.
- Protective terminal cover to prevent direct contact.
- Feature label with all the connection and protection instructions.



NEW head design

- Increased wiring insulation.
- Clearer features.
- Easier connection.
- More uniform, compact and robust design.

Definition and applications

The QB and QC control and manoeuvre transformers are specially designed for applications that require the adaptation of small voltages or where galvanic isolation is required for small loads or with safety voltages.

The QD transformers provide galvanic isolation between primary and secondary. **Its main applications include protection from single-phase electrical contacts** and isolation of the load / isolation of the network as well as the creation of neutrals referenced to ground.

Indicated for naval, wind farm, solar, pool, garden and railway installations and for oil rigs.

Manufacturing characteristics

- Protection against indirect contacts.
- Convertible from Class I to Class II.
- LED indicator lamp included.
- Full power in all sockets.
- Voltage selection by metallic bridges (included).
- Mounted on **DIN rail (up to 250 VA)** or with screws.
- Option of special fabrications if the standard specification are inadequate.
- Protection against damp, saline and corrosive environments.
- Greater mechanical resistance to vibrations, power surges and transient harmonics.
- All the transformers are checked automatically one by one and the compliance test report is created in accordance with the corresponding standard.

Technical features - standard model

Power	40 VA to 2500 VA
Insulators	Class B - 130 °C
Winding	Class HC - 200 °C
Room temperature	45 °C
Frequency	50-60 Hz
Noise	≤ 40 dB
Protection rating	IP20
Cooling	AN
Includes	LED indicator lamp
Mounting	With screws (for all powers) Mounting on DIN 46277/3 rail (up to 100 VA)
Standards	IEC/EN/UNE-EN 61558, CE
Protection	Convertible from Class I to Class II
Voltage selection	Metallic bridges, included
Operation	Continuous
Test voltage	4.6 kV (1 min., 50 Hz) between primary and secondary 3.2 kV (1 min., 50 Hz) between primary and ground 2.5 kV (1 min., 50 Hz) between secondary and ground

Electrical diagrams

- **Up to 100 VA**

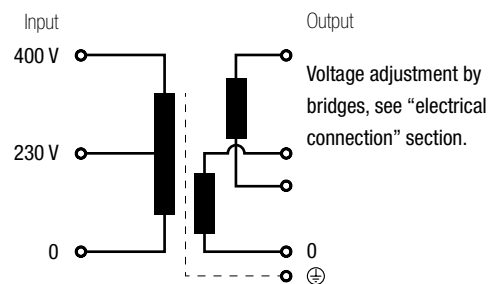

- **From 160 VA**

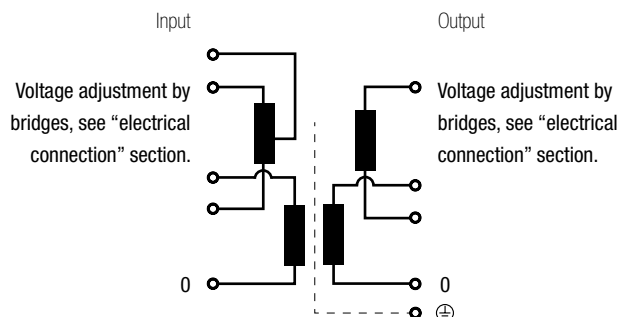



Q SERIES

Encapsulated control, manoeuvre and isolation

Electrical connection

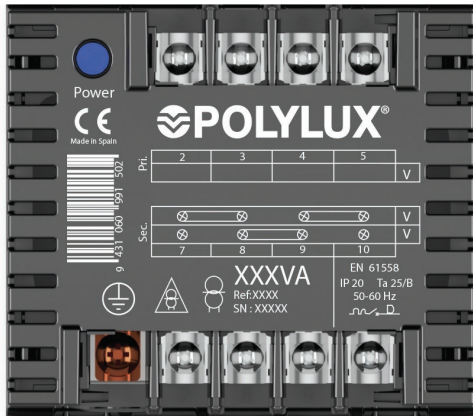

≤ 100 VA

Input:

- 230 V | Connection: 2-3
- 400 V | Connection: 2-4

Output:

- References QB 12 V | Connection: 7-10
- References QC 24 V | Bridges: 7-8 / 9-10
- References QD 115 V
- References QB 24 V | Connection: 7-10
- References QC 48 V | Bridges: 8-9
- References QD 230 V



Connection video

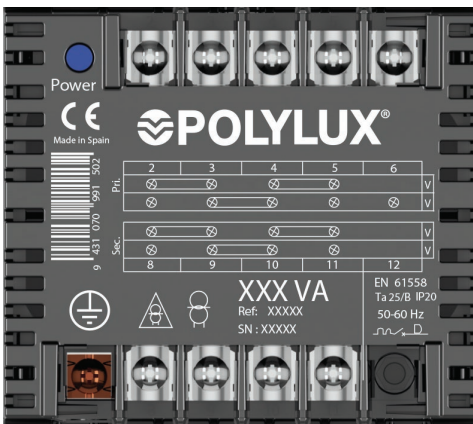

From 160 VA to 1000 VA

Input:

- 230 V | Connection: 2-5
Bridges: 2-3 / 4-5
- 400 V | Connection: 2-6
Bridges: 3-4
- 460 V | Connection: 2-5
Bridges: 3-4

Output:

- References QB 12 V | Connection: 8-11
- References QC 24 V | Bridges: 8-9 / 10-11
- References QD 115 V
- References QB 24 V | Connection: 8-11
- References QC 48 V | Bridges: 9-10
- References QD 230 V



Connection video

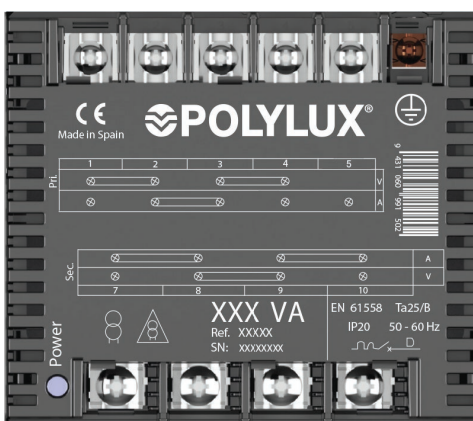

≥ 1250 VA

Input:

- 230 V | Connection: 1-4
Bridges: 1-2 / 3-4
- 400 V | Connection: 1-5
Bridges: 2-3
- 460 V | Connection: 1-4
Bridges: 2-3

Output:

- Reference QC 24 V | Connection: 7-10
- References QD 115 V | Bridges: 7-8 / 9-10
- Reference QC 48 V | Connection: 7-10
- References QD 230 V | Bridges: 8-9



Connection video



Q SERIES

Encapsulated control, manoeuvre and isolation



Terminal types

Terminal blocks	Dimensions mm				Maximum tightening torque N-m	Primary		Secondary	
	A	B	C	Ø		Power VA		Power VA	
						From	To	From	To
Terminal M3	8	11	9	M3	0.5	40	100	40	100
Terminal M4	10	13.5	12	M4	1.1	160	1000	160	250
Terminal M5	15	18.5	14	M5	2.5	1250	2500	315	1000
Terminal M6	15.5	20.4	13	M6	4	-	-	1250	2500

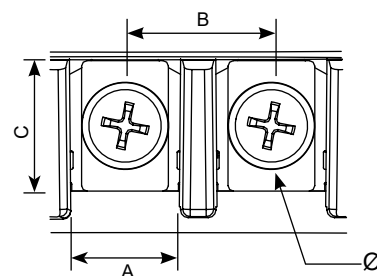

Theoretical data - standard model

Power VA	Reference	Input current A			Output current A		Input protections (A) (MCB -> D / Fuse -> aM)			Output protections (A) (MCB -> C / Fuse -> gG)	
		230 V	400 V	460 V	V1	V2	230 V	400 V	460 V	V1	V2
QB (output voltage 12 V [V1] or 24 V [V2])											
40	QB40	0.17	0.10	-	3.33	1.67	0.4 (--/T)	0.2 (--/T)	-	3.15	1.6
63	QB63	0.27	0.16	-	5.25	2.63	0.63 (--/T)	0.315 (--/T)	-	5	2.5
100	QB100	0.43	0.25	-	8.33	4.17	1 (--/T)	0.5 (--/T)	-	8	4
160	QB160	0.70	0.40	0.35	13.33	6.67	1.6	1	0.63	12.5	6
200	QB200	0.87	0.50	0.43	16.67	8.33	2	1	1	16	8
250	QB250	1.09	0.63	0.54	20.83	10.42	2.5	1.25	1.25	20	10
315	QB315	1.37	0.79	0.68	26.25	13.13	3.15	1.6	1.6	25	12.5
400	QB400	1.74	1.00	0.87	33.33	16.67	4	2	2	32	16
500	QB500	2.17	1.25	1.09	41.67	20.83	5	2.5	2.5	40	20
QC (output voltage 24 V [V1] or 48 V [V2])											
40	QC40	0.17	0.10	-	1.67	0.83	0.4 (--/T)	0.2 (--/T)	-	1.6	0.8 (--/T)
63	QC63	0.27	0.16	-	2.63	1.31	0.63 (--/T)	0.315 (--/T)	-	2.5	1.25
100	QC100	0.43	0.25	-	4.17	2.08	1 (--/T)	0.5 (--/T)	-	4	2
160	QC160	0.70	0.40	0.35	6.67	3.33	1.6	1	0.63	6	3.15
200	QC200	0.87	0.50	0.43	8.33	4.17	2	1	1	8	4
250	QC250	1.09	0.63	0.54	10.42	5.21	2.5	1.25	1.25	10	5
315	QC315	1.37	0.79	0.68	13.13	6.56	3.15	1.6	1.6	12.5	6
400	QC400	1.74	1.00	0.87	16.67	8.33	4	2	2	16	8
500	QC500	2.17	1.25	1.09	20.83	10.42	5	2.5	2.5	20	10
630	QC630	2.74	1.58	1.37	26.25	13.13	6	3.15	3.15	25	12.5
800	QC800	3.48	2.00	1.74	33.33	16.67	8	4	4	32	16
1000	QC1000	4.35	2.50	2.17	41.67	20.83	10	5	5	40	20
1250	QC1250	5.43	3.13	2.72	52.08	26.04	10	6.3	5	50	25
1600	QC1600	6.96	4.00	3.48	66.67	33.33	16	8	8	63	32
2000	QC2000	8.70	5.00	4.35	83.33	41.67	20	10	10	80	40
QD (output voltage 115 V [V1] or 230 V [V2])											
40	QD40	0.17	0.10	-	0.35	0.17	0.4 (--/T)	0.2 (--/T)	-	0.31 (--/T)	0.16 (--/T)
63	QD63	0.27	0.16	-	0.55	0.27	0.63 (--/T)	0.315 (--/T)	-	0.5 (--/T)	0.25 (--/T)
100	QD100	0.43	0.25	-	0.87	0.43	1 (--/T)	0.5 (--/T)	-	0.8 (--/T)	0.4 (--/T)
160	QD160	0.70	0.40	0.35	1.39	0.70	1.6	1	0.63	1.25	0.63 (--/T)
200	QD200	0.87	0.50	0.43	1.74	0.87	2	1	1	1.6	0.8 (--/T)
250	QD250	1.09	0.63	0.54	2.17	1.09	2.5	1.25	1.25	2	1
315	QD315	1.37	0.79	0.68	2.74	1.37	3.15	1.6	1.6	2.5	1.25
400	QD400	1.74	1.00	0.87	3.48	1.74	4	2	2	3.15	1.6
500	QD500	2.17	1.25	1.09	4.35	2.17	5	2.5	2.5	4	2
630	QD630	2.74	1.58	1.37	5.48	2.74	6	3.15	3.15	5	2.5
800	QD800	3.48	2.00	1.74	6.96	3.48	8	4	4	6	4
1000	QD1000	4.35	2.50	2.17	8.70	4.35	10	5	5	8	4
1250	QD1250	5.43	3.13	2.72	10.87	5.43	10	6.3	5	10	5
1600	QD1600	6.96	4.00	3.48	13.91	6.96	16	8	8	12.5	6
2000	QD2000	8.70	5.00	4.35	17.39	8.70	20	10	10	16	8
2500	QD2500	10.87	6.25	5.43	21.74	10.87	25	12.5	12.5	20	10

Q SERIES

Encapsulated control, manoeuvre and isolation



Theoretical data - standard model

Power VA	Reference	Maximum cross-section input conductor (mm ²)						Maximum cross-section output conductor (mm ²)			
		230 V		400 V		460 V		V1		V2	
		Flexible	Rigid	Flexible	Rigid	Flexible	Rigid	Flexible	Rigid	Flexible	Rigid
QB (output voltage 12 V [V1] or 24 V [V2])											
40	QB40	0.5	0.5	0.5	0.5	-	-	1	1.5	1	1.5
63	QB63	0.5	0.5	0.5	0.5	-	-	1.5	2	1	1.5
100	QB100	0.5	1	0.5	0.5	-	-	2	2.5	1.5	2
160	QB160	0.5	1	0.5	0.5	0.5	0.5	2.5	4	1.5	2
200	QB200	0.5	1	0.5	1	0.5	1	4	-	2	2.5
250	QB250	0.5	1	0.5	1	0.5	1	4	-	2.5	4
315	QB315	0.5	1	0.5	1	0.5	1	6	-	2.5	4
400	QB400	1	1.5	0.5	1	0.5	1	8	-	4	-
500	QB500	1	1.5	0.5	1	0.5	1	10	-	4	-
QC (output voltage 24 V [V1] or 48 V [V2])											
40	QC40	0.5	0.5	0.5	0.5	-	-	1	1.5	0.5	1
63	QC63	0.5	0.5	0.5	0.5	-	-	1	1.5	0.5	1
100	QC100	0.5	1	0.5	0.5	-	-	1.5	2	1	1.5
160	QC160	0.5	1	0.5	0.5	0.5	0.5	1.5	2	1	1.5
200	QC200	0.5	1	0.5	1	0.5	1	2	2.5	1.5	2
250	QC250	0.5	1	0.5	1	0.5	1	2.5	4	1.5	2
315	QC315	0.5	1	0.5	1	0.5	1	2.5	4	1.5	2
400	QC400	1	1.5	0.5	1	0.5	1	4	-	2	2.5
500	QC500	1	1.5	0.5	1	0.5	1	4	-	2.5	4
630	QC630	1	1.5	1	1.5	0.5	1	6	-	2.5	4
800	QC800	1	1.5	1	1.5	1	1.5	8	-	4	-
1000	QC1000	1.5	2	1	1.5	1	1.5	10	-	4	-
1250	QC1250	1.5	2	1	1.5	1	1.5	16	-	6	-
1600	QC1600	1.5	2	1	1.5	1	1.5	16	-	8	-
2000	QC2000	2	2.5	1.5	2	1.5	2	20	-	10	-
QD (output voltage 115 V [V1] or 230 V [V2])											
40	QD40	0.5	0.5	0.5	0.5	-	-	0.5	0.5	0.5	0.5
63	QD63	0.5	0.5	0.5	0.5	-	-	0.5	1	0.5	0.5
100	QD100	0.5	1	0.5	0.5	-	-	0.5	1	0.5	1
160	QD160	0.5	1	0.5	0.5	0.5	0.5	0.5	1	0.5	1
200	QD200	0.5	1	0.5	1	0.5	1	1	1.5	0.5	1
250	QD250	0.5	1	0.5	1	0.5	1	1	1.5	0.5	1
315	QD315	0.5	1	0.5	1	0.5	1	1	1.5	0.5	1
400	QD400	1	1.5	0.5	1	0.5	1	1	1.5	1	1.5
500	QD500	1	1.5	0.5	1	0.5	1	1.5	2	1	1.5
630	QD630	1	1.5	1	1.5	0.5	1	1.5	2	1	1.5
800	QD800	1	1.5	1	1.5	1	1.5	1.5	2	1	1.5
1000	QD1000	1.5	2	1	1.5	1	1.5	2	2.5	1.5	2
1250	QD1250	1.5	2	1	1.5	1	1.5	2.5	4	1.5	2
1600	QD1600	1.5	2	1	1.5	1	1.5	2.5	4	1.5	2
2000	QD2000	2	2.5	1.5	2	1.5	2	4	-	2	2.5
2500	QD2500	2.5	4	1.5	2	1.5	2	4	-	2.5	4



Q SERIES

Encapsulated control, manoeuvre and isolation

Measurements

Power VA	Input voltage V	Output voltage V References			External dimensions mm			Fastening elements mm			Weight kg
		12 / 24	24 / 48	115 / 230	A	B	C	D	E	Ø	
40	230 / 400	QB40	QC40	QD40	84	101	98	88	55	5	1.2
63	230 / 400	QB63	QC63	QD63	84	101	98	88	55	5	1.5
100	230 / 400	QB100	QC100	QD100	84	101	98	88	55	5	1.8
160	230 / 400 / 460	QB160	QC160	QD160	106	123	118	110	74	5	2.9
200	230 / 400 / 460	QB200	QC200	QD200	106	123	118	110	74	5	3.4
250	230 / 400 / 460	QB250	QC250	QD250	106	123	118	110	74	5	4
315	230 / 400 / 460	QB315	QC315	QD315	118	138	131	121	88	6	5
400	230 / 400 / 460	QB400	QC400	QD400	118	138	131	121	88	6	5.5
500	230 / 400 / 460	QB500	QC500	QD500	136	162	156	145	104	6	8.7
630	230 / 400 / 460		QC630	QD630	136	162	156	145	104	6	8.8
800	230 / 400 / 460		QC800	QD800	136	162	156	145	104	6	9.7
1000	230 / 400 / 460		QC1000	QD1000	136	162	180	145	104	6	10.5
1250	230 / 400 / 460		QC1250	QD1250	233	241	244	219	175	7	25.6
1600	230 / 400 / 460		QC1600	QD1600	233	241	274	219	175	7	30
2000	230 / 400 / 460		QC2000	QD2000	233	241	314	219	175	7	37.6
2500	230 / 400 / 460			QD2500	233	241	314	219	175	7	38.5

Up to QB500, QC1000 and QD1000

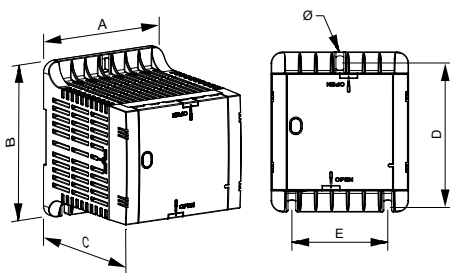

From QC1250 and QD1250

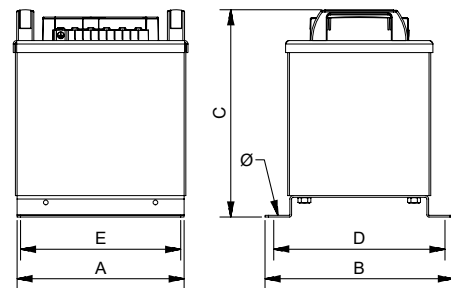

On-request manufacturing options (please see prices)

Power	From 25 VA to 2500 VAA
Voltage	From 6 V to 1100 V
Shields	Primary / secondary, primary / ground and secondary / ground

Creating neutral

To perform this procedure: use a single-phase transformer with the appropriate power and connect it to primary with both phases and create a bridge at the output between one of the output phases and ground. This line will act as neutral from this moment.

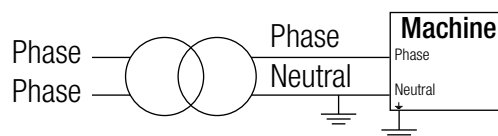



Q SERIES

Encapsulated control, manoeuvre and isolation

Feature plate structure

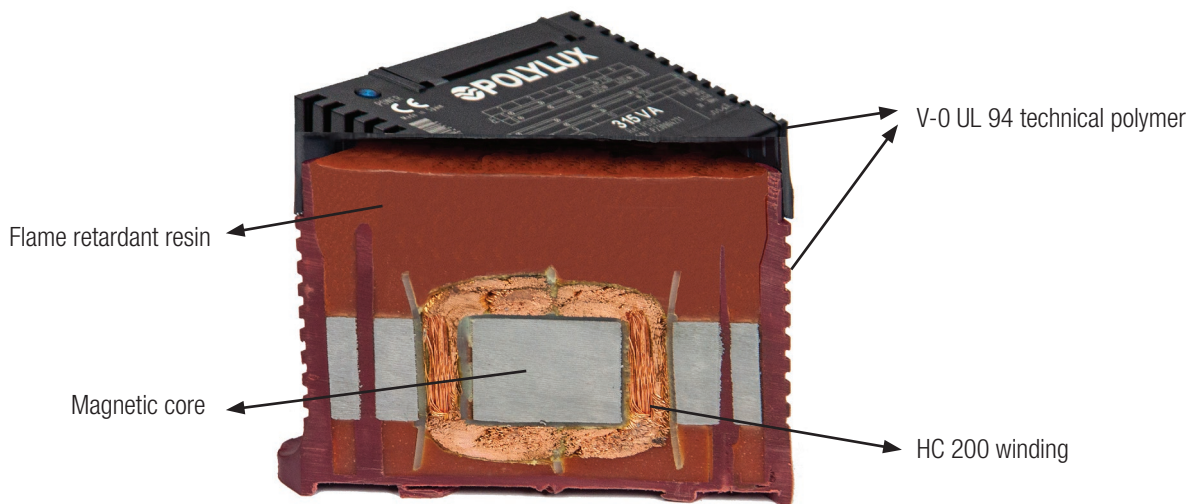
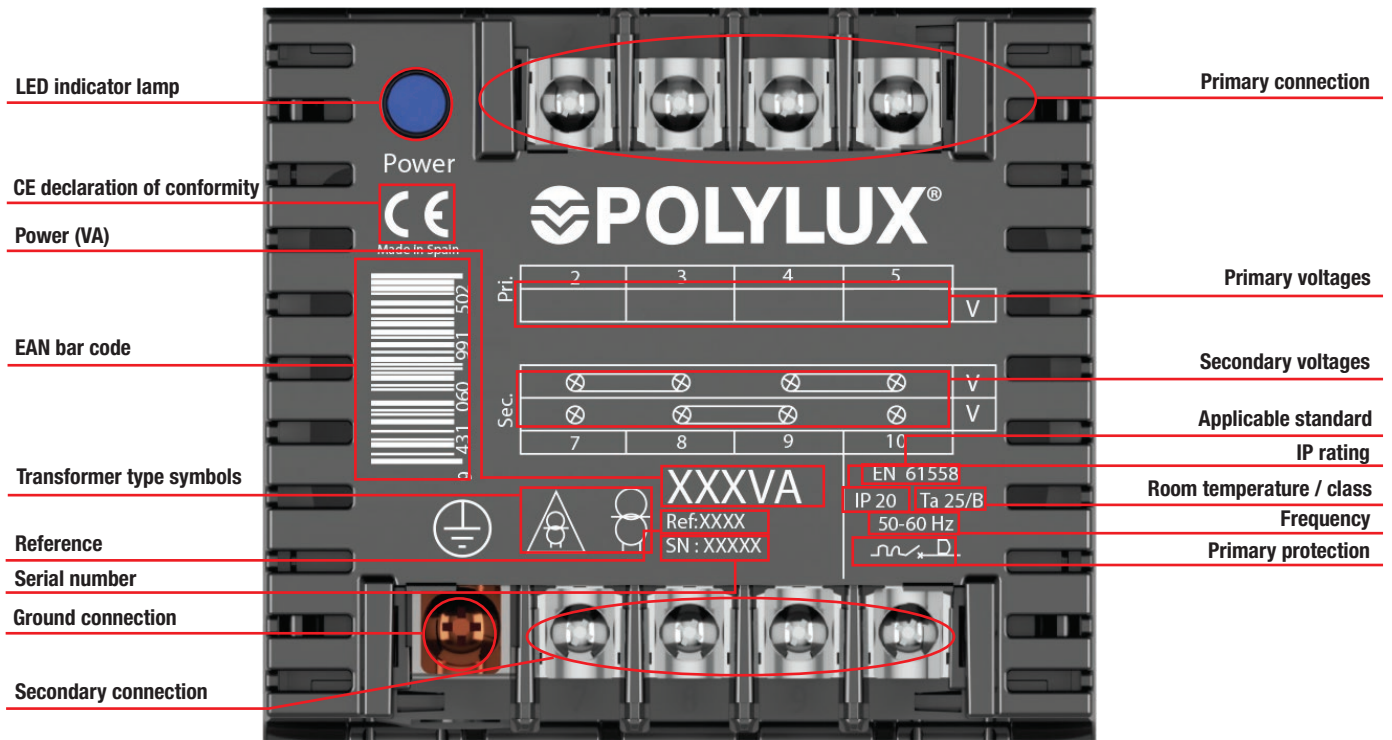

Sectioned transformer

N SERIES

Encapsulated control, manoeuvre and isolation



Technical features - standard model

Power	40 VA to 5000 VA
Insulators	Class B - 130 °C
Winding	Class HC - 200 °C
Room temperature	45 °C
Frequency	50-60 Hz
Noise	≤ 45 dB
Protection rating	IP20
Cooling	AN
Mounting	With screws (for all powers) Mounting on DIN 46277/3 rail (up to 100 VA)
Standards	IEC/EN/UNE-EN 61558, CE
Voltage selection	Metallic bridges, included
Operation	Continuous
Test voltage	4.6 kV (1 min., 50 Hz) between primary and secondary 3.2 kV (1 min., 50 Hz) between primary and ground 2.5 kV (1 min., 50 Hz) between secondary and ground

Definition and applications

The NB and NC control and manoeuvre transformers are specially designed for applications that require the adaptation of small voltages or where galvanic isolation is required for small loads or with safety voltages.

The ND transformers do not provide galvanic isolation between primary and secondary. **Its main applications include protection from single-phase electrical contacts** and isolation of the load / isolation of the network as well as the creation of neutrals referenced to ground.

Indicated for naval, wind farm, solar, pool, garden and railway installations and for oil rigs.

Manufacturing characteristics

- Terminal protection cover.
- Mounting on **DIN rail (up to 100 VA)** or with screws.
- Electrical feature and connection label.
- Protection against damp, saline and corrosive environments.
- Greater mechanical resistance to vibrations, power surges and transient harmonics.
- All the transformers are checked automatically one by one and the compliance test report is created in accordance with the corresponding standard.

Electrical diagrams

- **Up to 160 VA**

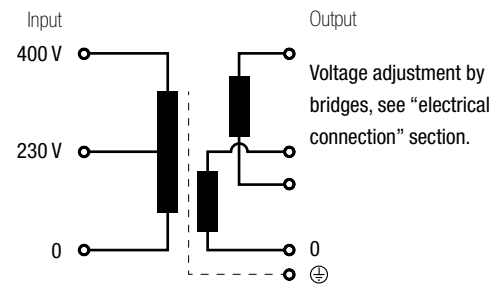

- **From 200 VA**

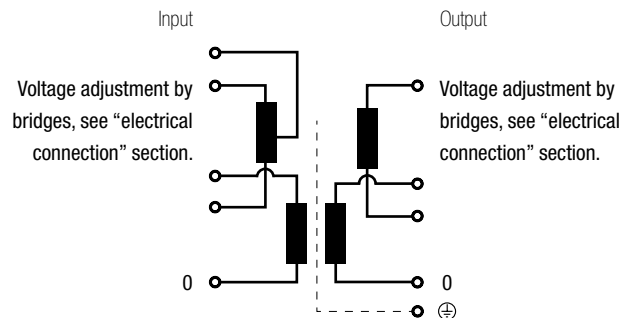



N SERIES

Encapsulated control, manoeuvre and isolation

Electrical connection

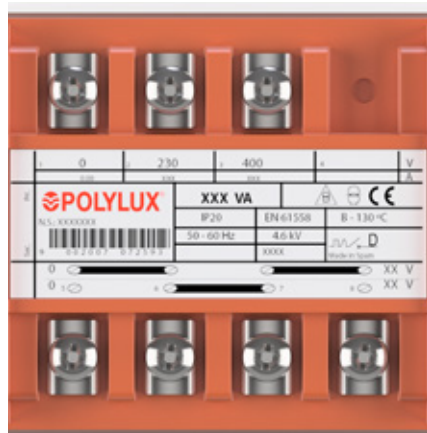

≤ 160 VA

Input:

- 230 V | Connection: 1-2
- 400 V | Connection: 1-3

Output:

- Reference NB 12 V | Connection: 5-8
Bridges: 5-6 / 7-8
- Reference NC 24 V
- Reference ND 115 V
- Reference NB 24 V | Connection: 5-8
Bridges: 6-7
- Reference NC 48 V
- Reference ND 230 V



Connection video

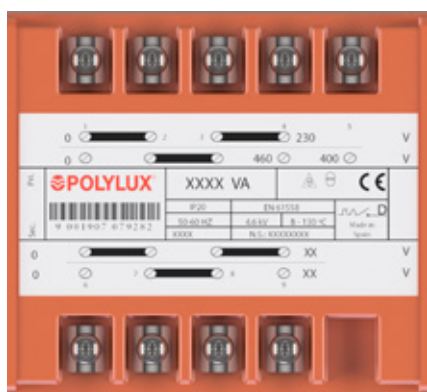

≥ 200 VA

Input:

- 230 V | Connection: 1-4
Bridges: 1-2 / 3-4
- 400 V | Connection: 1-5
Bridges: 2-3
- 460 V | Connection: 1-4
Bridges: 2-3

Output:

- Reference NB 12 V | Connection: 6-9
Bridges: 6-7 / 8-9
- Reference NC 24 V
- Reference ND 115 V
- Reference NB 24 V | Connection: 6-9
Bridges: 7-8
- Reference NC 48 V
- Reference ND 230 V



Connection video

Terminal types

Terminal blocks	Dimensions mm				Maximum tightening torque N-m	Primary Power VA		Secondary Power VA	
	A	B	C	Ø		From	To	From	To
Terminal M4	9.7	16	10.1	M4	1.1	40	400	40	400
Terminal M5	15.5	21.5	15.6	M5	2.5	500	3150	500	3150
Terminal M6	15.5	21.5	15.6	M6	4	4000	5000	4000	5000

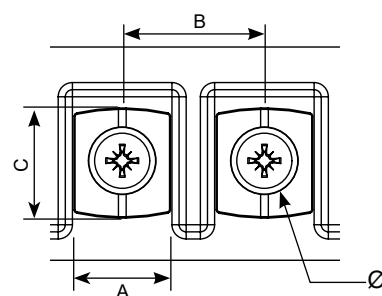

N SERIES

Encapsulated control, manoeuvre and isolation



Theoretical data - standard model

Power VA	Reference	Input current A			Output current A		Input protections (A) (MCB -> D / Fuse -> aM)			Output protections (A) (MCB -> C / Fuse -> gG)	
		230 V	400 V	460 V	V1	V2	230 V	400 V	460 V	V1	V2
NB (output voltage 12 V [V1] or 24 V [V2])											
40	NB40	0.17	0.1	-	3.33	1.67	0.4 (-/T)	0.2 (-/T)	-	3.15	1.6
100	NB100	0.43	0.25	-	8.33	4.17	1 (-/T)	0.5 (-/T)	-	8	4
200	NB200	0.87	0.5	0.43	16.67	8.33	2	1	1	16	8
315	NB315	1.37	0.79	0.68	26.25	13.13	3.15	1.6	1.6	25	12.5
NC (output voltage 24 V [V1] or 48 V [V2])											
40	NC40	0.17	0.1	-	1.67	0.83	0.4 (-/T)	0.2 (-/T)	-	1.6	0.8 (-/T)
100	NC100	0.43	0.25	-	4.17	2.08	1 (-/T)	0.5 (-/T)	-	4	2
200	NC200	0.87	0.5	0.43	8.33	4.17	2	1	1	8	4
315	NC315	1.37	0.79	0.68	13.13	6.56	3.15	1.6	1.6	12.5	6
630	NC630	2.74	1.58	1.37	26.25	13.13	6	3.15	3.15	25	12.5
1000	NC1000	4.35	2.5	2.17	41.67	20.83	10	5	5	40	20
2000	NC2000	8.7	5	4.35	83.33	41.67	20	10	10	80	40
ND (output voltage 115 V [V1] or 230 V [V2])											
40	ND40	0.17	0.1	-	0.35	0.17	0.4 (-/T)	0.2 (-/T)	-	0.31 (-/T)	0.16 (-/T)
100	ND100	0.43	0.25	-	0.87	0.43	1 (-/T)	0.5 (-/T)	-	0.8 (-/T)	0.4 (-/T)
200	ND200	0.87	0.5	0.43	1.74	0.87	2	1	1	1.6	0.8 (-/T)
315	ND315	1.37	0.79	0.68	2.74	1.37	3.15	1.6	1.6	2.5	1.25
630	ND630	2.74	1.58	1.37	5.48	2.74	6	3.15	3.15	5	2.5
1000	ND1000	4.35	2.5	2.17	8.7	4.35	10	5	5	8	4
2000	ND2000	8.7	5	4.35	17.39	8.7	20	10	10	16	8
3150	ND3150	13.7	7.88	6.85	27.39	13.7	32	16	16	25	12.5
5000	ND5000	21.74	12.5	10.87	43.48	21.74	50	25	25	40	20

N SERIES

Encapsulated control, manoeuvre and isolation



Theoretical data - standard model

Power VA	Reference	Maximum cross-section input conductor (mm ²)						Maximum cross-section output conductor (mm ²)			
		230 V		400 V		460 V		V1		V2	
		Flexible	Rigid	Flexible	Rigid	Flexible	Rigid	Flexible	Rigid	Flexible	Rigid
NB (output voltage 12 V [V1] or 24 V [V2])											
40	NB40	0.5	0.5	0.5	0.5	-	-	1	1.5	1	1.5
100	NB100	0.5	1	0.5	0.5	-	-	2	2.5	1.5	2
200	NB200	0.5	1	0.5	1	0.5	1	4	-	2	2.5
315	NB315	0.5	1	0.5	1	0.5	1	6	-	2.5	4
NC (output voltage 24 V [V1] or 48 V [V2])											
40	NC40	0.5	0.5	0.5	0.5	-	-	1	1.5	0.5	1
100	NC100	0.5	1	0.5	0.5	-	-	1.5	2	1	1.5
200	NC200	0.5	1	0.5	1	0.5	1	2	2.5	1.5	2
315	NC315	0.5	1	0.5	1	0.5	1	2.5	4	1.5	2
630	NC630	1	1.5	1	1.5	0.5	1	6	-	2.5	4
1000	NC1000	1.5	2	1	1.5	1	1.5	10	-	4	-
2000	NC2000	2	2.5	1.5	2	1.5	2	20	-	10	-
ND (output voltage 115 V [V1] or 230 V [V2])											
40	ND40	0.5	0.5	0.5	0.5	-	-	0.5	0.5	0.5	0.5
100	ND100	0.5	1	0.5	0.5	-	-	0.5	1	0.5	1
200	ND200	0.5	1	0.5	1	0.5	1	1	1.5	0.5	1
315	ND315	0.5	1	0.5	1	0.5	1	1	1.5	0.5	1
630	ND630	1	1.5	1	1.5	0.5	1	1.5	2	1	1.5
1000	ND1000	1.5	2	1	1.5	1	1.5	2	2.5	1.5	2
2000	ND2000	2	2.5	1.5	2	1.5	2	4	-	2	2.5
3150	ND3150	2.5	4	2	2.5	1.5	2	6	-	2.5	4
5000	ND5000	4	-	2.5	4	2.5	4	10	-	4	-

N SERIES

Encapsulated control, manoeuvre and isolation



Measurements

Power VA	Input voltage V	Output voltage V References			External dimensions mm			Fastening elements mm			Weight kg
		12 / 24	24 / 48	115 / 230	A	B	C	D	E	Ø	
40	230 / 400	NB40	NC40	ND40	75	97	84	80	56	6	1.2
100	230 / 400	NB100	NC100	ND100	75	96	100	80	56	6	1.8
200	230 / 400 / 460	NB200	NC200	ND200	96	112	106	96	76	6	3.2
315	230 / 400 / 460	NB315	NC315	ND315	108	124	124	106	89	6	4.5
630	230 / 400 / 460		NC630	ND630	126	148	166	125	102	7	9.1
1000	230 / 400 / 460		NC1000	ND1000	150	165	180	145	125	7	13.6
2000	230 / 400 / 460		NC2000	ND2000	195	198	228	178	173	7	25.3
3150	230 / 400 / 460			ND3150	195	198	268	178	173	7	35.8
5000	230 / 400 / 460			ND5000	240	235	300	212	220	7	55

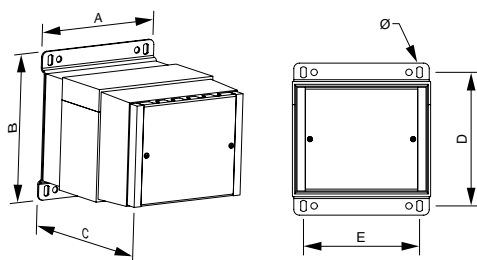

On-request manufacturing options (please see prices)

Power	From 25 VA to 5000 VA
Voltage	From 6 V to 1100 V
Shields	Primary / secondary, primary / ground and secondary / ground

Creating neutral

To perform this procedure: use a single-phase transformer with the appropriate power and connect it to primary with both phases and create a bridge at the output between one of the output phases and ground. This line will act as neutral from this moment.

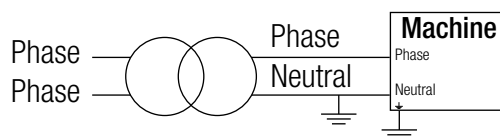

N SERIES

Encapsulated control, manoeuvre and isolation



Feature plate structure

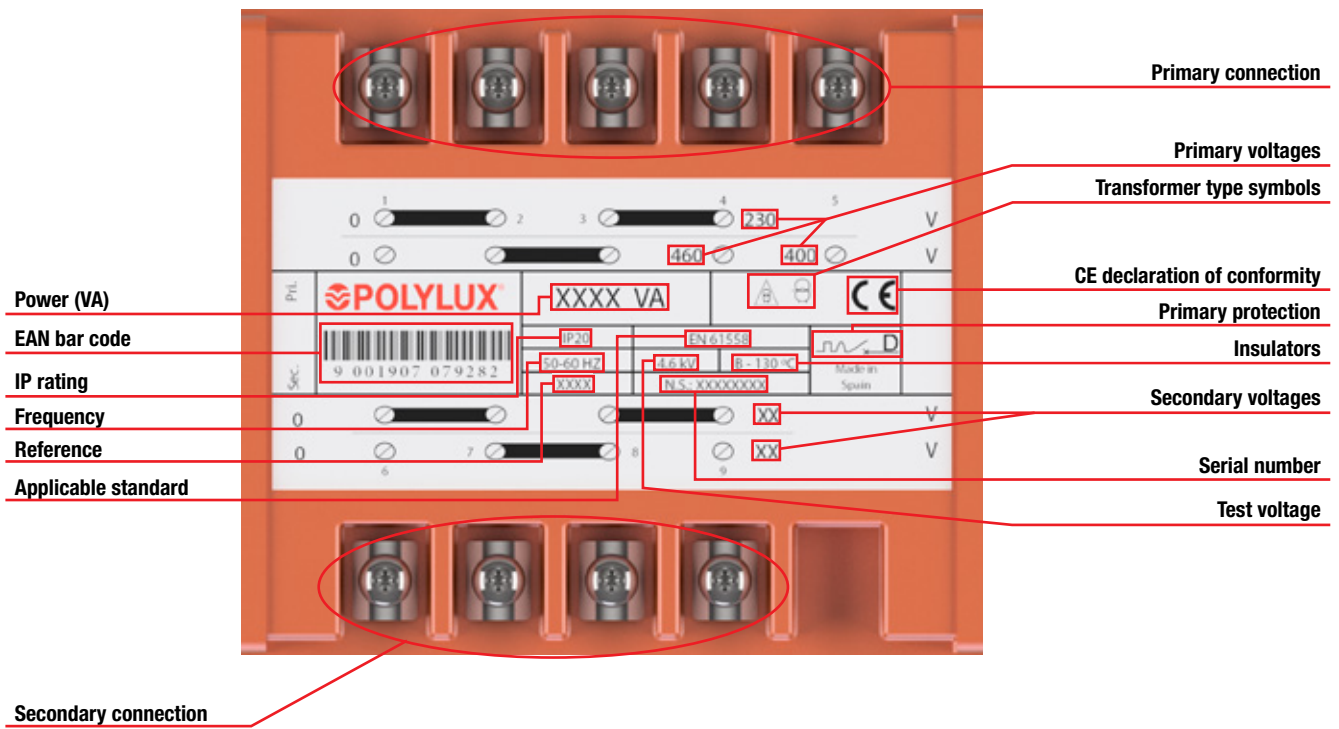



PTU SERIES

Ultra-isolation · Input **230 V** · Output **230 V**

Definition and applications

The PTA ultra-isolation transformers series is designed for high-noise environments where shielding is required to ensure good signal quality.

This series has two types:

- With 1 electrostatic shield (PTU1P) for minor perturbations between primary and secondary
- With 3 electrostatic shields (PTU3P) for high perturbations at the start of the winding between primary and secondary, and at the end of the winding.

Manufacturing characteristics

All the versions have the following features in common:

- Anti-flash dip varnishing. Ensures greater compactation, isolation and noise elimination.
- Connection terminals made of copper, welded and inserted in blocks to prevent hazards caused by expansion that may lead to poor connection.
- Noise and parasite attenuation depending on whether there are 1 or 3 electrostatic shields.
- All the transformers are checked automatically one by one and the compliance test report is created in accordance with the corresponding standard.



Up to 2500 VA

- Technical polymer box.
- UL 94 V-0 flame retardant material up to 2500 VA (PTU1P) or 2000 VA (PTU3P).
- Protective terminal cover to prevent direct contact.
- Ventilation ducts at the top and along the perimeter.
- Feature label with all the connection and protection instructions.



From 2500 VA

- Epoxy painted metal box resistant to all types of damp and corrosive environments from 3150 VA (PTU1P) or 2500 VA (PTU3P).
- Protective terminal cover to prevent direct contact.
- Ventilation ducts along the box perimeter.
- Feature label with all the connection and protection instructions.



NEW head design

- Increased wiring insulation.
- Clearer features.
- Easier connection.
- More uniform, compact and robust design.

Technical features - standard model

Power	40 VA to 5000 VA
Insulators	Class B - 130 °C
Winding	Class HC - 200 °C
Room temperature	45 °C
Frequency	50-60 Hz
Noise	≤ 65 dB (PTU1P), ≤ 80 dB (PTU3P)
Protection rating	IP20
Cooling	ANAN
Includes	LED indicator lamp 1 (PTU1P) or 3 (PTU3P) electrostatic shields
Mounting	With screws (for all powers) Mounting on DIN 46277/3 rail up to 250 VA (PTU1P) or up to 200 VA (PTU3P)
Standards	IEC/EN/UNE-EN 61558, CE
Protection	Convertible from Class I to Class II up to 2500 VA (PTU1P) or 2000 VA (PTU3P)
Operation	Continuous
Test voltage	4 kV (1 min., 50 Hz)

Electrical diagrams

- **With 1 electrostatic shield (PTU1P)**

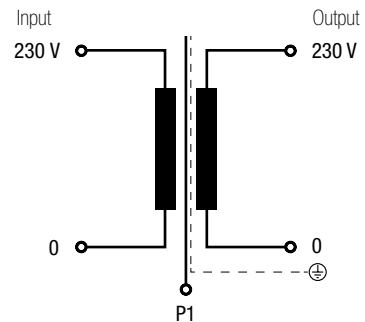

- **With 3 electrostatic shield (PTU3P)**

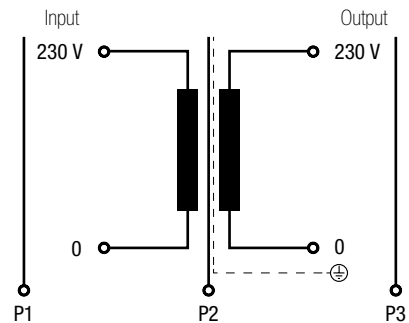



PTU SERIES

Ultra-isolation · Input 230 V · Output 230 V

Electrical connection

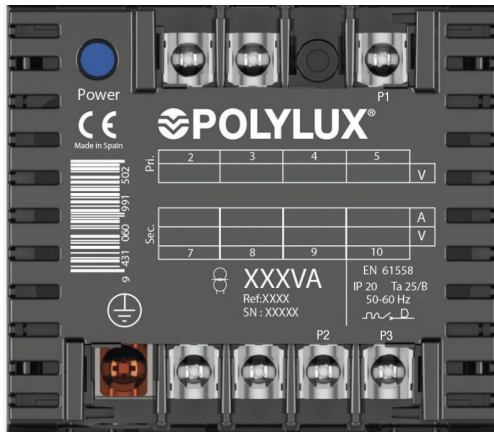

*Image for PTU3P (P1-P2-P3), in PTU1P (P1).

≤ 100 VA PTU1P

≤ 63 VA PTU3P

Input:

- 230 V | Connection: 2-3

Output:

- 230 V | Connection: 7-8

Electrostatic shield connection:

- PTU1P | Connection: 10
- PTU3P | Connection: 5 / 9 / 10



*Image for PTU3P (P1-P2-P3), in PTU1P (P1).

From 160 VA to 1000 VA PTU1P

From 100 VA to 800 VA PTU3P

Input:

- 230 V | Connection: 2-3

Output:

- 230 V | Connection: 8-9

Electrostatic shield connection:

- PTU1P | Connection: 11
- PTU3P | Connection: 6 / 11 / 12

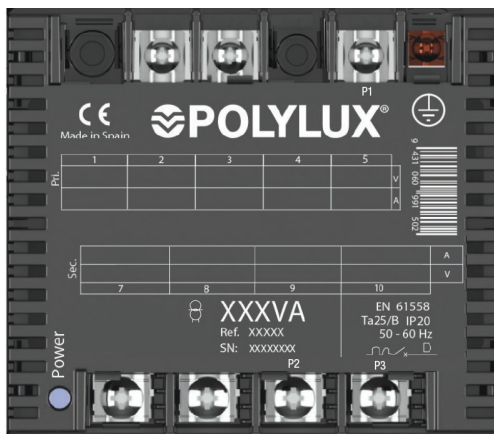

*Image for PTU3P (P1-P2-P3), in PTU1P (P1).

≥ 1250 VA PTU1P

≥ 1000 VA PTU3P

Input:

- 230 V | Connection: 2-3

Output:

- 230 V | Connection: 7-8

Electrostatic shield connection:

- PTU1P | Connection: 10
- PTU3P | Connection: 5 / 9 / 10





PTU SERIES

Ultra-isolation · Input 230 V · Output 230 V

Terminal types

PTU1P									
Terminal blocks	Dimensions mm				Maximum tightening torque N·m	Primary Power VA		Secondary Power VA	
	A	B	C	Ø		From	To	From	To
	Terminal M3	8	11	9		M3	0.5	40	100
Terminal M4	10	13.5	12	M4	1.1	160	1000	160	250
Terminal M5	15	18.5	14	M5	2.5	1250	4000	315	1000
Terminal M6	15.5	20.4	13	M6	4	-	-	1250	4000

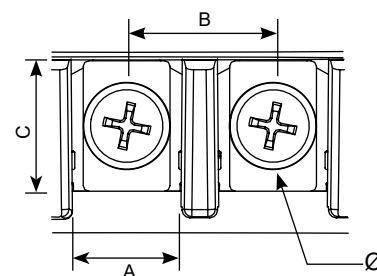

PTU3P									
Terminal blocks	Dimensions mm				Maximum tightening torque N·m	Primary Power VA		Secondary Power VA	
	A	B	C	Ø		From	To	From	To
	Terminal M3	8	11	9		M3	0.5	40	63
Terminal M4	10	13.5	12	M4	1.1	100	800	100	200
Terminal M5	15	18.5	14	M5	2.5	1000	4000	315	1000
Terminal M6	15.5	20.4	13	M6	4	-	-	1000	4000

Theoretical data - standard model

Power VA	Reference	Input current A	Output current A	Maximum cross-section conductor (mm ²)		Input protections (A) (MCB -> D / Fuse -> aM)	Output protections (A) (MCB -> C / Fuse -> gG)
				Flexible	Rigid		
PTU1P							
40	PTU1P40	0.17	0.17	0.5	0.5	0.4 (--/T)	0.16 (--/T)
63	PTU1P63	0.27	0.27	0.5	0.5	0.63 (--/T)	0.25 (--/T)
100	PTU1P100	0.43	0.43	0.5	0.5	1 (--/T)	0.4 (--/T)
160	PTU1P160	0.70	0.70	0.5	0.5	1.6	0.63 (--/T)
200	PTU1P200	0.87	0.87	0.5	0.5	2	0.8 (--/T)
250	PTU1P250	1.09	1.09	0.5	0.5	2.5	1
315	PTU1P315	1.37	1.37	0.5	0.5	3.15	1.25
400	PTU1P400	1.74	1.74	0.5	0.5	4	1.6
500	PTU1P500	2.17	2.17	0.5	1	5	2
630	PTU1P630	2.74	2.74	1	1	6	2.5
800	PTU1P800	3.48	3.48	1	1	8	4
1000	PTU1P1000	4.35	4.35	1	1.5	10	4
1250	PTU1P1250	5.43	5.43	1.5	1.5	10	5
1600	PTU1P1600	6.96	6.96	1.5	2.5	16	6
2000	PTU1P2000	8.70	8.70	2.5	2.5	20	8
2500	PTU1P2500	10.87	10.87	2.5	4	25	10
3150	PTU1P3150	13.70	13.70	4	4	32	12.5
4000	PTU1P4000	17.39	17.39	4	-	40	16
PTU3P							
40	PTU3P40	0.17	0.17	0.5	0.5	0.4 (--/T)	0.16 (--/T)
63	PTU3P63	0.27	0.27	0.5	0.5	0.63 (--/T)	0.25 (--/T)
100	PTU3P100	0.43	0.43	0.5	0.5	1 (--/T)	0.4 (--/T)
160	PTU3P160	0.70	0.70	0.5	0.5	1.6	0.63 (--/T)
200	PTU3P200	0.87	0.87	0.5	0.5	2	0.8 (--/T)
250	PTU3P250	1.09	1.09	0.5	0.5	2.5	1
315	PTU3P315	1.37	1.37	0.5	0.5	3.15	1.25
400	PTU3P400	1.74	1.74	0.5	0.5	4	1.6
500	PTU3P500	2.17	2.17	0.5	1	5	2
630	PTU3P630	2.74	2.74	1	1	6	2.5
800	PTU3P800	3.48	3.48	1	1	8	4
1000	PTU3P1000	4.35	4.35	1	1.5	10	4
1250	PTU3P1250	5.43	5.43	1.5	1.5	10	5
1600	PTU3P1600	6.96	6.96	1.5	2.5	16	6
2000	PTU3P2000	8.70	8.70	2.5	2.5	20	8
2500	PTU3P2500	10.87	10.87	2.5	4	25	10
3150	PTU3P3150	13.70	13.70	4	4	32	12.5
4000	PTU3P4000	17.39	17.39	4	-	40	16



PTU SERIES

Ultra-isolation · Input 230 V · Output 230 V

Measurements

Power VA	With 1 electrostatic shield PTU1P								With 3 electrostatic shield PTU3P							
	Ref.	External dimensions mm			Fastening elements mm			Weight kg	Ref.	External dimensions mm			Fastening elements mm			Weight kg
		A	B	C	D	E	∅			A	B	C	D	E	∅	
40	PTU1P40	84	101	98	88	55	5	1.1	PTU3P40	84	101	98	88	55	5	1.3
63	PTU1P63	84	101	98	88	55	5	1.3	PTU3P63	84	101	98	88	55	5	1.6
100	PTU1P100	84	101	98	88	55	5	1.6	PTU3P100	106	123	118	110	74	5	2.3
160	PTU1P160	106	123	118	110	74	5	2.3	PTU3P160	106	123	118	110	74	5	2.8
200	PTU1P200	106	123	118	110	74	5	2.8	PTU3P200	106	123	118	110	74	5	3.6
250	PTU1P250	106	123	118	110	74	5	3.6	PTU3P250	118	138	131	121	88	6	4.1
315	PTU1P315	118	138	131	121	88	6	4.1	PTU3P315	118	138	131	121	88	6	4.8
400	PTU1P400	118	138	131	121	88	6	4.8	PTU3P400	136	162	156	145	104	6	6
500	PTU1P500	136	162	156	145	104	6	6	PTU3P500	136	162	156	145	104	6	7.8
630	PTU1P630	136	162	156	145	104	6	7.8	PTU3P630	136	162	156	145	104	6	8.7
800	PTU1P800	136	162	156	145	104	6	8.7	PTU3P800	136	162	180	145	104	6	9.6
1000	PTU1P1000	136	162	180	145	104	6	9.6	PTU3P1000	214	225	284	195	175	7	16.6
1250	PTU1P1250	214	225	284	195	175	7	16.6	PTU3P1250	214	225	284	195	175	7	20.8
1600	PTU1P1600	214	225	284	195	175	7	20.8	PTU3P1600	214	225	284	195	175	7	25.9
2000	PTU1P2000	214	225	284	195	175	7	25.9	PTU3P2000	214	225	284	195	175	7	28.7
2500	PTU1P2500	214	225	284	195	175	7	28.7	PTU3P2500	247	260	349	233	223	7	36.7
3150	PTU1P3150	247	260	349	233	223	7	36.7	PTU3P3150	247	260	349	233	223	7	43.8
4000	PTU1P4000	247	260	349	233	223	7	54.3	PTU3P4000	247	260	349	233	223	7	56.1

Up to PTU1P1000
Up to PTU3P800

From PTU1P1250 to PTU1P2500
From PTU3P1000 to PTU3P2000

From PTU1P3150
From PTU3P2500

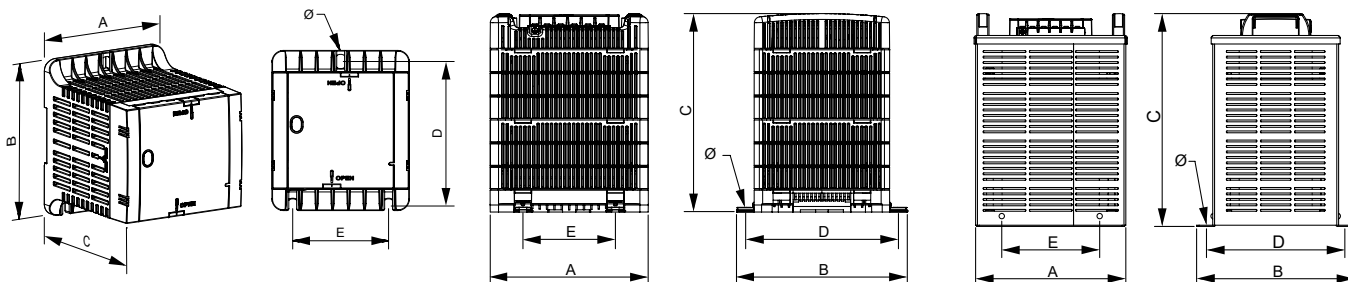

On-request manufacturing options (please see prices)

Power	From 25 VA to 4000 VA
Voltage	From 6 V to 1100 V





PTU SERIES

Ultra-isolation · Input 230 V · Output 230 V

Feature plate structure

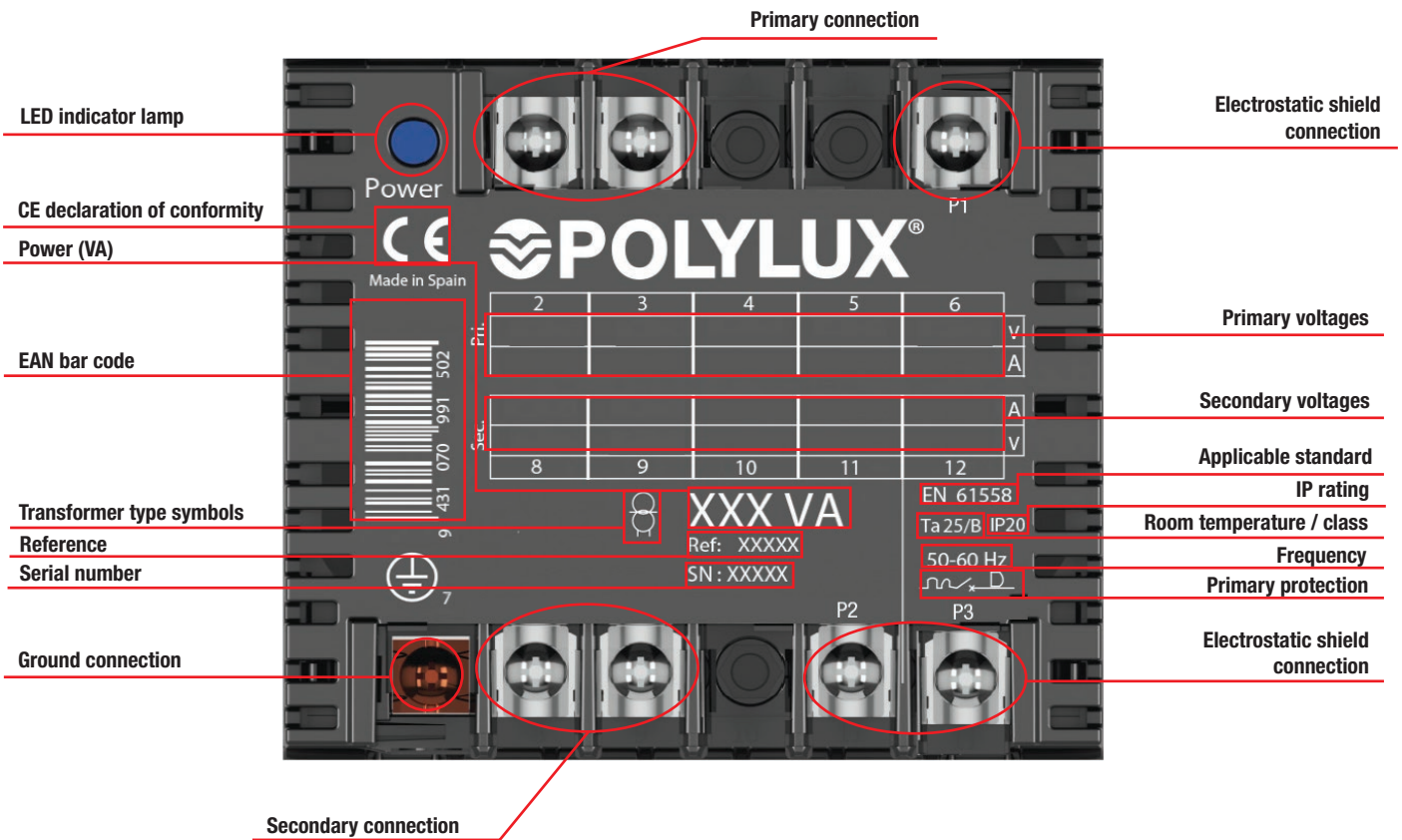



QTU SERIES

Encapsulated ultra-isolation · Input **230 V** · Output **230 V**

Definition and applications

The QTU series is designed for high electrical noise environments where shielding is required to ensure good signal quality.

In addition, the resin encapsulation makes the QTU transformers the best option for areas that require great resistance to vibrations, damp or corrosion.

This series has two types:

- With 1 electrostatic shield (QTU1P) for minor perturbations between primary and secondary
- With 3 electrostatic shields (QTU3P) for high perturbations at the start of the winding between primary and secondary, and at the end of the winding.

Manufacturing characteristics

- Protected against indirect contacts.
- Convertible from Class I to Class II up to 1000 VA (QTU1P) or 800 VA (QTU3P).
- LED indicator lamp included.
- Mounted on **DIN rail (up to 100 VA in QTU1P or up to 63 VA in QTU3P)** or with screws.
- All the live parts of these transformers are encapsulated in resin, which is particularly indicated for working in damp, saline and corrosive environments.
- They have greater resistance to current surges and transient harmonics.
- Greater mechanical resistance to vibrations and undesirable movements.
- Noise and parasite attenuation depending on whether there are 1 or 3 electrostatic shields.
- Uniform heat dissipation.
- All the transformers are checked automatically one by one and the compliance test report is created in accordance with the corresponding standard.



Up to 1000 VA

- Technical polymer box.
- UL 94 V-0 flame retardant material up to 1000 VA (QTU1P) or 800 VA (QTU3P).
- Protective terminal cover to prevent direct contact.
- Feature label with all the connection and protection instructions.



From 1250 VA

- Completely encapsulated in flame retardant resin from 1250 VA (QTU1P) or 1000 VA (QTU3P).
- Protective terminal cover to prevent direct contact.
- Feature label with all the connection and protection instructions.



NEW head design

- Increased wiring insulation.
- Clearer features.
- Easier connection.
- More uniform, compact and robust design.

Technical features - standard model

Power	40 VA to 2500 VA for QTU1P 40 VA to 2000 VA for QTU3P
Insulators	Class B - 130 °C
Winding	Class HC - 200 °C
Room temperature	45 °C
Frequency	50-60 Hz
Noise	≤ 65 dB (QTU1P), ≤ 80 dB (QTU3P)
Protection rating	IP20
Cooling	AN
Includes	LED indicator lamp 1 (QTU1P) or 3 (QTU3P) electrostatic shields
Mounting	With screws (for all powers) Mounted on DIN 46277/3 rail up to 100 VA (QTU1P) or up to 63 VA (QTU3P)
Standards	IEC/EN/UNE-EN 61558, CE
Protection	Convertible from Class I to Class II up to 1000 VA (QTU1P) or 800 VA (QTU3P)
Operation	Continuous
Test voltage	4 kV (1 min., 50 Hz)

Electrical diagrams

- **With 1 electrostatic shield (QTU1P)**

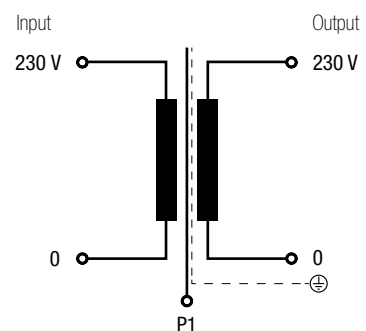

- **With 3 electrostatic shield (QTU3P)**

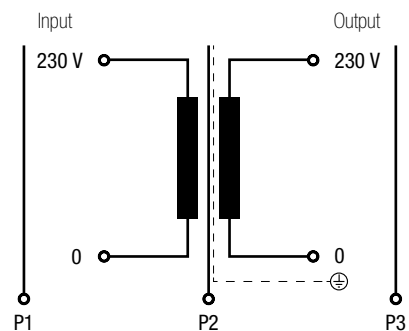



QTU SERIES

Encapsulated ultra-isolation · Input 230 V · Output 230 V

Electrical connection

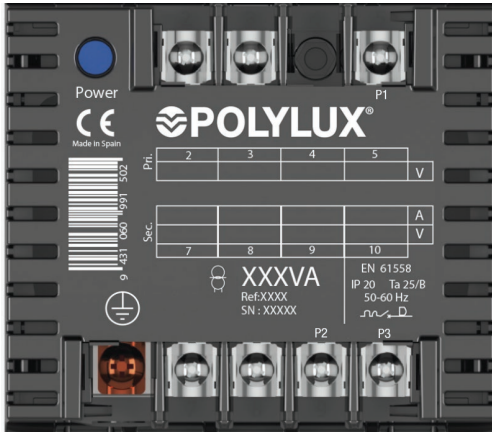

*Image for QTU3P (P1-P2-P3), in QTU1P (P1).

≤ 100 VA QTU1P

≤ 63 VA QTU3P

Input:

- 230 V | Connection: 2-3

Output:

- 230 V | Connection: 7-8

Electrostatic shield connection:

- QTU1P | Connection: 10
- QTU3P | Connection: 5 / 9 / 10

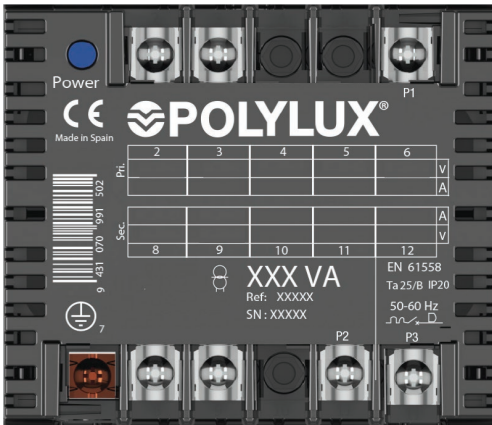

*Image for QTU3P (P1-P2-P3), in QTU1P (P1).

From 160 VA to 1000 VA QTU1P

From 100 VA to 800 VA QTU3P

Input:

- 230 V | Connection: 2-3

Output:

- 230 V | Connection: 8-9

Electrostatic shield connection:

- QTU1P | Connection: 11
- QTU3P | Connection: 6 / 11 / 12



*Image for QTU3P (P1-P2-P3), in QTU1P (P1).

≥ 1250 VA QTU1P

≥ 1000 VA QTU3P

Input:

- 230 V | Connection: 2-3

Output:

- 230 V | Connection: 7-8

Electrostatic shield connection:

- QTU1P | Connection: 10
- QTU3P | Connection: 5 / 9 / 10



QTU SERIES

Encapsulated ultra-isolation · Input 230 V · Output 230 V

Terminal types

QTU1P									
Terminal blocks	Dimensions mm				Maximum tightening torque N-m	Primary Power VA		Secondary Power VA	
	A	B	C	Ø		From	To	From	To
	Terminal M3	8	11	9		M3	0.5	40	100
Terminal M4	10	13.5	12	M4	1.1	160	1000	160	250
Terminal M5	15	18.5	14	M5	2.5	1250	2500	315	1000
Terminal M6	15.5	20.4	13	M6	4	-	-	1250	2500

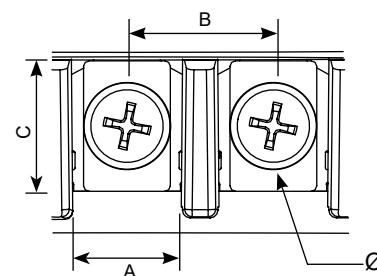

QTU3P									
Terminal blocks	Dimensions mm				Maximum tightening torque N-m	Primary Power VA		Secondary Power VA	
	A	B	C	Ø		From	To	From	To
	Terminal M3	8	11	9		M3	0.5	40	63
Terminal M4	10	13.5	12	M4	1.1	100	800	100	200
Terminal M5	15	18.5	14	M5	2.5	1000	2500	315	1000
Terminal M6	15.5	20.4	13	M6	4	-	-	1000	2500

Theoretical data - standard model

Power VA	Reference	Input current A	Output current A	Maximum cross-section conductor (mm ²)		Input protections (A) (MCB -> D / Fuse -> aM)	Output protections (A) (MCB -> C / Fuse -> gG)
				Flexible	Rigid		
QTU1P							
40	QTU1P40	0.17	0.17	0.5	0.5	0.4 (--/T)	0.16 (--/T)
63	QTU1P63	0.27	0.27	0.5	0.5	0.63 (--/T)	0.25 (--/T)
100	QTU1P100	0.43	0.43	0.5	0.5	1 (--/T)	0.4 (--/T)
160	QTU1P160	0.70	0.70	0.5	0.5	1.6	0.63 (--/T)
200	QTU1P200	0.87	0.87	0.5	0.5	2	0.8 (--/T)
250	QTU1P250	1.09	1.09	0.5	0.5	2.5	1
315	QTU1P315	1.37	1.37	0.5	0.5	3.15	1.25
400	QTU1P400	1.74	1.74	0.5	0.5	4	1.6
500	QTU1P500	2.17	2.17	0.5	1	5	2
630	QTU1P630	2.74	2.74	1	1	6	2.5
800	QTU1P800	3.48	3.48	1	1	8	4
1000	QTU1P1000	4.35	4.35	1	1.5	10	4
1250	QTU1P1250	5.43	5.43	1.5	1.5	10	5
1600	QTU1P1600	6.96	6.96	1.5	2.5	16	6
2000	QTU1P2000	8.70	8.70	2.5	2.5	20	8
2500	QTU1P2500	10.87	10.87	2.5	4	25	10
QTU3P							
40	QTU3P40	0.17	0.17	0.5	0.5	0.4 (--/T)	0.16 (--/T)
63	QTU3P63	0.27	0.27	0.5	0.5	0.63 (--/T)	0.25 (--/T)
100	QTU3P100	0.43	0.43	0.5	0.5	1 (--/T)	0.4 (--/T)
160	QTU3P160	0.70	0.70	0.5	0.5	1.6	0.63 (--/T)
200	QTU3P200	0.87	0.87	0.5	0.5	2	0.8 (--/T)
250	QTU3P250	1.09	1.09	0.5	0.5	2.5	1
315	QTU3P315	1.37	1.37	0.5	0.5	3.15	1.25
400	QTU3P400	1.74	1.74	0.5	0.5	4	1.6
500	QTU3P500	2.17	2.17	0.5	1	5	2
630	QTU3P630	2.74	2.74	1	1	6	2.5
800	QTU3P800	3.48	3.48	1	1	8	4
1000	QTU3P1000	4.35	4.35	1	1.5	10	4
1250	QTU3P1250	5.43	5.43	1.5	1.5	10	5
1600	QTU3P1600	6.96	6.96	1.5	2.5	16	6
2000	QTU3P2000	8.70	8.70	2.5	2.5	20	8



QTU SERIES

Encapsulated ultra-isolation · Input 230 V · Output 230 V

Measurements

Power VA	With 1 electrostatic shield QTU1P								With 3 electrostatic shields QTU3P							
	Ref.	External dimensions mm			Fastening elements mm			Weight kg	Ref.	External dimensions mm			Fastening elements mm			Weight kg
		A	B	C	D	E	∅			A	B	C	D	E	∅	
40	QTU1P40	84	101	98	88	55	5	1.2	QTU3P40	84	101	98	88	55	5	1.5
63	QTU1P63	84	101	98	88	55	5	1.5	QTU3P63	84	101	98	88	55	5	1.8
100	QTU1P100	84	101	98	88	55	5	1.8	QTU3P100	106	123	118	110	74	5	2.9
160	QTU1P160	106	123	118	110	74	5	2.9	QTU3P160	106	123	118	110	74	5	3.4
200	QTU1P200	106	123	118	110	74	5	3.4	QTU3P200	106	123	118	110	74	5	4
250	QTU1P250	106	123	118	110	74	5	4	QTU3P250	118	138	131	121	88	6	5
315	QTU1P315	118	138	131	121	88	6	5	QTU3P315	118	138	131	121	88	6	5.5
400	QTU1P400	118	138	131	121	88	6	5.5	QTU3P400	136	162	156	145	104	6	8.7
500	QTU1P500	136	162	156	145	104	6	8.7	QTU3P500	136	162	156	145	104	6	8.8
630	QTU1P630	136	162	156	145	104	6	8.8	QTU3P630	136	162	156	145	104	6	9.7
800	QTU1P800	136	162	156	145	104	6	9.7	QTU3P800	136	162	180	145	104	6	10.5
1000	QTU1P1000	136	162	180	145	104	6	10.5	QTU3P1000	233	241	244	219	175	7	25.6
1250	QTU1P1250	233	241	244	219	175	7	25.6	QTU3P1250	233	241	274	219	175	7	30
1600	QTU1P1600	233	241	274	219	175	7	30	QTU3P1600	233	241	314	219	175	7	37.6
2000	QTU1P2000	233	241	314	219	175	7	37.6	QTU3P2000	233	241	314	219	175	7	38.5
2500	QTU1P2500	233	241	314	219	175	7	38.5								

Up to QTU1P1000
Up to QTU3P800

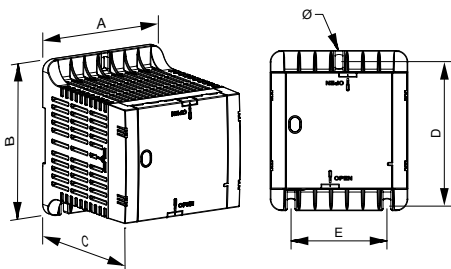

From QTU1P1250
From QTU3P1000

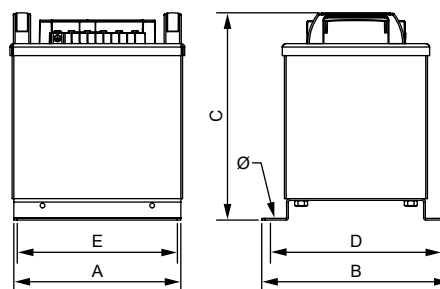

On-request manufacturing options (please see prices)

Power	From 25 VA to 2500 VA
Voltage	From 6 V to 1100 V



QTU SERIES

Encapsulated ultra-isolation · Input 230 V · Output 230 V

Feature plate structure

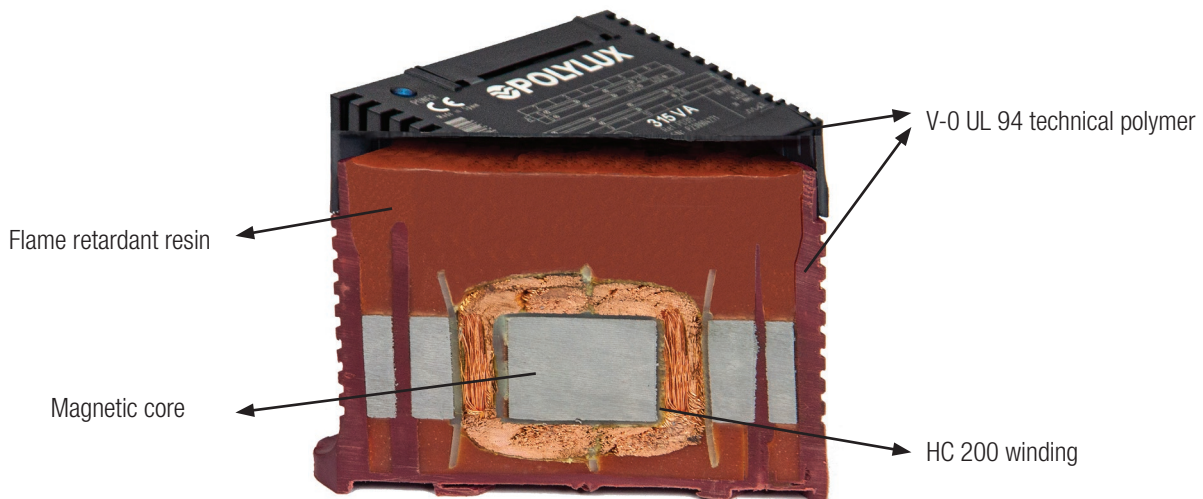
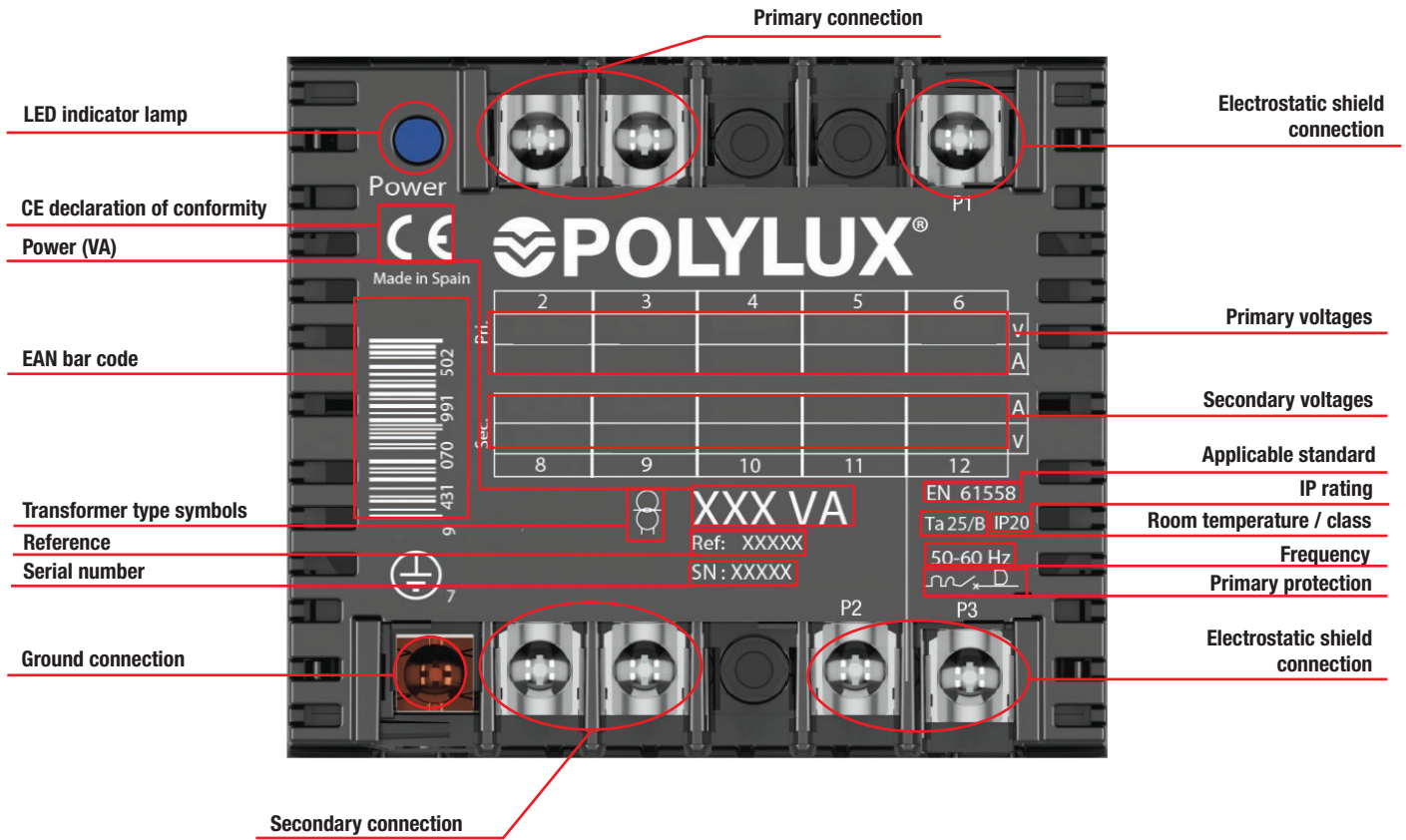

Sectioned transformer



PIL SERIES

For LED spotlights in pools and gardens · Input 230 V · Output 12 V



Definition and applications

An isolation and safety transformer with an output voltage of 12 V.

Their main applications are for pool and garden spotlights and they can be used as control and manoeuvre transformers in installations that pose a danger of contacts for persons.

Manufacturing characteristics

All the versions have the following features in common:

- Anti-flash dip varnishing. Ensures greater compactation, isolation and noise elimination.
- Connection terminals made of copper, welded and inserted in blocks to prevent hazards caused by expansion that may lead to poor connection.
- Option of mounting on **DIN rail for all powers**.
- IP20 enclosure, V-0 flame-retardant polymer box that complies with UL94.
- Safety Class I, convertible to Class II.
- LED indicator lamp included.
- All the transformers are checked automatically one by one and the compliance test report is created in accordance with the corresponding standard.

NEW head design

- Increased wiring insulation.
- Clearer features.
- Easier connection.
- More uniform, compact and robust design.



Technical features - standard model

Power	30 VA to 100 VA
Insulators	Class B - 130 °C
Winding	Class HC - 200 °C
Room temperature	45 °C
Frequency	50-60 Hz
Noise	≤ 45 dB
Protection rating	IP20
Cooling	ANAN
Includes	LED indicator lamp
Mounting	Mounted on DIN 46277/3 rail or with screws
Standards	IEC/EN/UNE-EN 61558, CE
Protection	Convertible from Class I to Class II
Operation	Continuous
Test voltage	4.6 kV (1 min., 50 Hz) between primary and secondary 3.2 kV (1 min., 50 Hz) between primary and ground 2.5 kV (1 min., 50 Hz) between secondary and ground

Electrical diagram

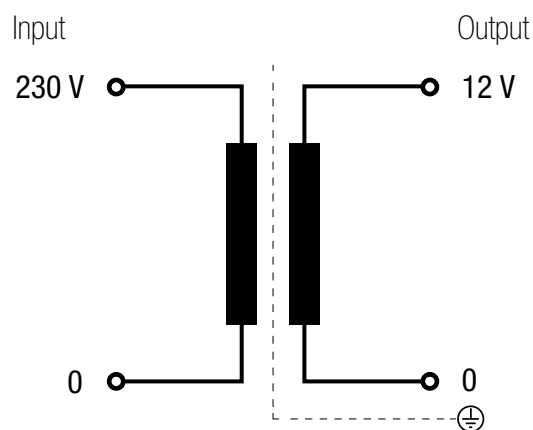



PIL SERIES

For LED spotlights in pools and gardens · Input 230 V · Output 12 V

Electrical connection

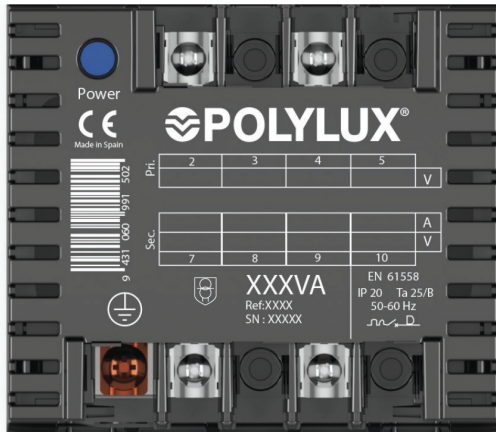

Compatible for all PIL series models

Input:

- 230 V | Connection: 2-4

Output:

- 12 V | Connection: 7-9

Configuration of spotlights for the different models:

- PIL30: suitable for 24 VA spotlights
- PIL60: suitable for one 37 VA or two 24 VA spotlights
- PIL100: suitable for two 37 VA spotlights

Terminal type

Terminal blocks	Dimensions mm				Maximum tightening torque N·m	Primary Power VA		Secondary Power VA	
	A	B	C	Ø		From	To	From	To
						Terminal M3	8	11	9

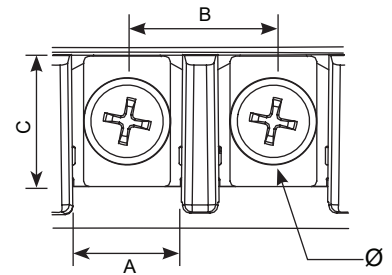

Theoretical data - standard model

Power VA	Reference	Input current A	Output current A	Maximum cross-section input conductor (mm ²)		Maximum cross-section output conductor (mm ²)		Input protections (A) (MCB -> D / Fuse -> aM)	Output protections (A) (MCB -> C / Fuse -> gG)
				Flexible	Rigid	Flexible	Rigid		
30	PIL30	0.13	2.5	0.5	0.5	1	1.5	0.3	2.5
60	PIL60	0.26	5	0.5	0.5	1.5	2	0.6	5
100	PIL100	0.43	8.3	0.5	1	2	2.5	1	8



PIL SERIES

For LED spotlights in pools and gardens · Input 230 V · Output 12 V

Measurements

Power	Ref.	External dimensions mm			Fastening elements mm			Weight kg
		A	B	C	D	E	Ø	
30	PIL30	69	92	80	79	45	5	0.87
60	PIL60	84	101	98	88	55	5	1.1
100	PIL100	84	101	98	88	55	5	1.6

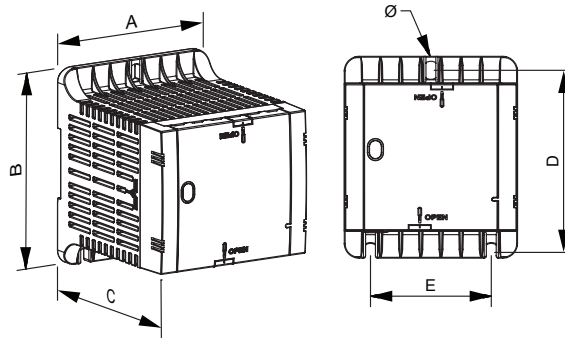

Feature plate structure

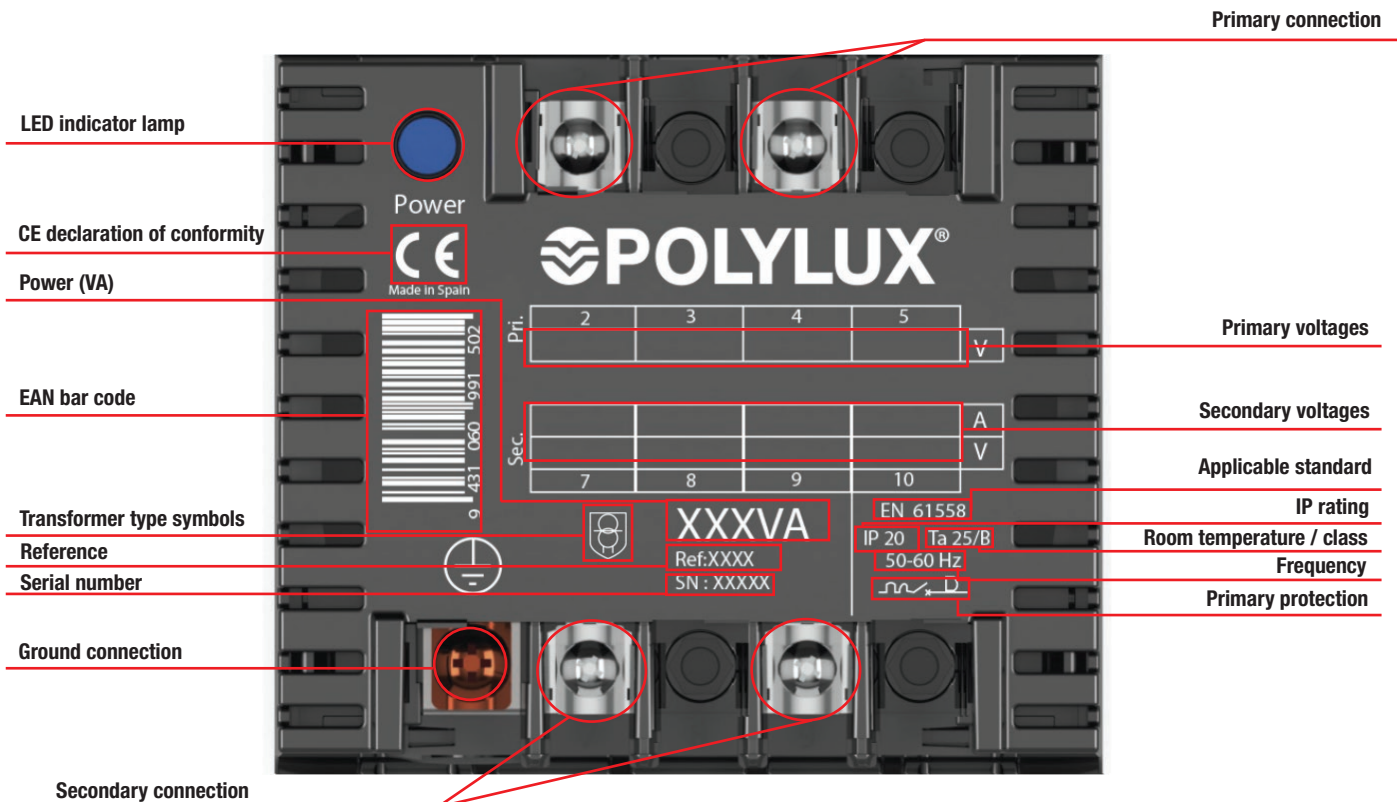



QIL SERIES

For LED spotlights in pools and gardens · Input 230 V · Output 12 V



Definition and applications

An isolation and safety transformer with an output voltage of 12 V.

Its main applications are spotlights in pools and gardens and it can be used as a control and manoeuvre transformer in installations that pose a risk of electrical contact for persons.

Manufacturing characteristics

All the versions have the following features in common:

- Encapsulated in flame retardant resin.
- Connection terminals made of copper, welded and inserted in blocks to prevent hazards caused by expansion that may lead to poor connection.
- Option of mounting on **DIN rail for all references**.
- IP20 enclosure, V-0 flame-retardant polymer box that complies with UL94.
- All the live parts of these transformers are encapsulated in resin, which is particularly indicated for working in damp, saline and corrosive environments.
- They have greater resistance to current surges and transient harmonics.
- Greater mechanical resistance to vibrations and undesirable movements.
- Safety Class I, convertible to Class II.
- LED indicator lamp included.
- All the transformers are checked automatically one by one and the compliance test report is created in accordance with the corresponding standard.

NEW head design

- Increased wiring insulation.
- Clearer features.
- Easier connection.
- More uniform, compact and robust design.



Technical features - standard model

Power	30 VA to 100 VA
Insulators	Class B - 130 °C
Winding	Class HC - 200 °C
Room temperature	45 °C
Frequency	50-60 Hz
Noise	≤ 40 dB
Protection rating	IP20
Cooling	AN
Includes	LED indicator lamp
Mounting	Mounted on DIN 46277/3 rail or with screws
Standards	IEC/EN/UNE-EN 61558, CE
Protection	Convertible from Class I to Class II
Operation	Continuous
Test voltage	4.6 kV (1 min., 50 Hz) between primary and secondary 3.2 kV (1 min., 50 Hz) between primary and ground 2.5 kV (1 min., 50 Hz) between secondary and ground

Electrical diagram

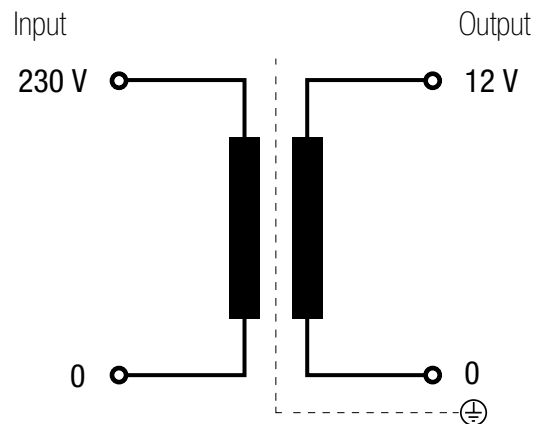



QIL SERIES

For LED spotlights in pools and gardens · Input 230 V · Output 12 V

Electrical connection

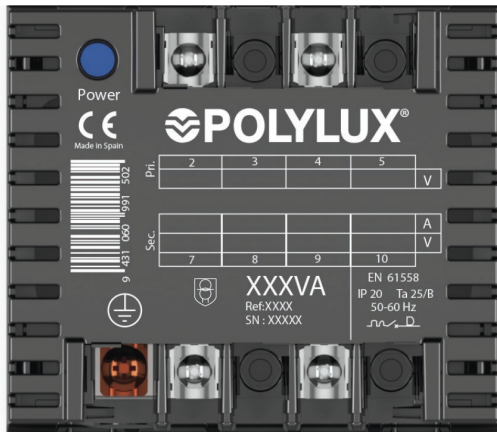

Compatible for all QIL series models

Input:

- 230 V | Connection: 2-4

Output:

- 12 V | Connection: 7-9

Configuration of spotlights for the different models:

- QIL30: suitable for 24 VA spotlights
- QIL60: suitable for one 37 VA or two 24 VA spotlights
- QIL100: suitable for two 37 VA spotlights

Terminal type

Terminal blocks	Dimensions mm				Maximum tightening torque N-m	Primary Power VA		Secondary Power VA	
	A	B	C	Ø		From	To	From	To
Terminal M3	8	11	9	M3	0.5	30	100	30	100

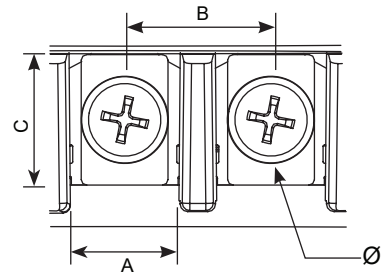

Theoretical data - standard model

Power VA	Reference	Input current A	Output current A	Maximum cross-section input conductor (mm ²)		Maximum cross-section output conductor (mm ²)		Input protections (A) (MCB -> D / Fuse -> aM)	Output protections (A) (MCB -> C / Fuse -> gG)
				Flexible	Rigid	Flexible	Rigid		
30	QIL30	0.13	2.5	0.5	0.5	1	1.5	0.3	2.5
60	QIL60	0.26	5	0.5	0.5	1.5	2	0.6	5
100	QIL100	0.43	8.3	0.5	1	2	2.5	1	8



QIL SERIES

For LED spotlights in pools and gardens · Input 230 V · Output 12 V

Measurements

Power VA	Ref.	External dimensions mm			Fastening elements mm			Weight kg
		A	B	C	D	E	Ø	
30	QIL30	69	92	80	79	45	5	0.94
60	QIL60	84	101	98	88	55	5	1.4
100	QIL100	84	101	98	88	55	5	1.8

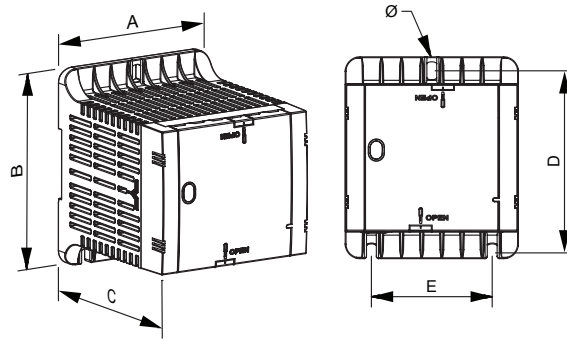

Feature plate structure

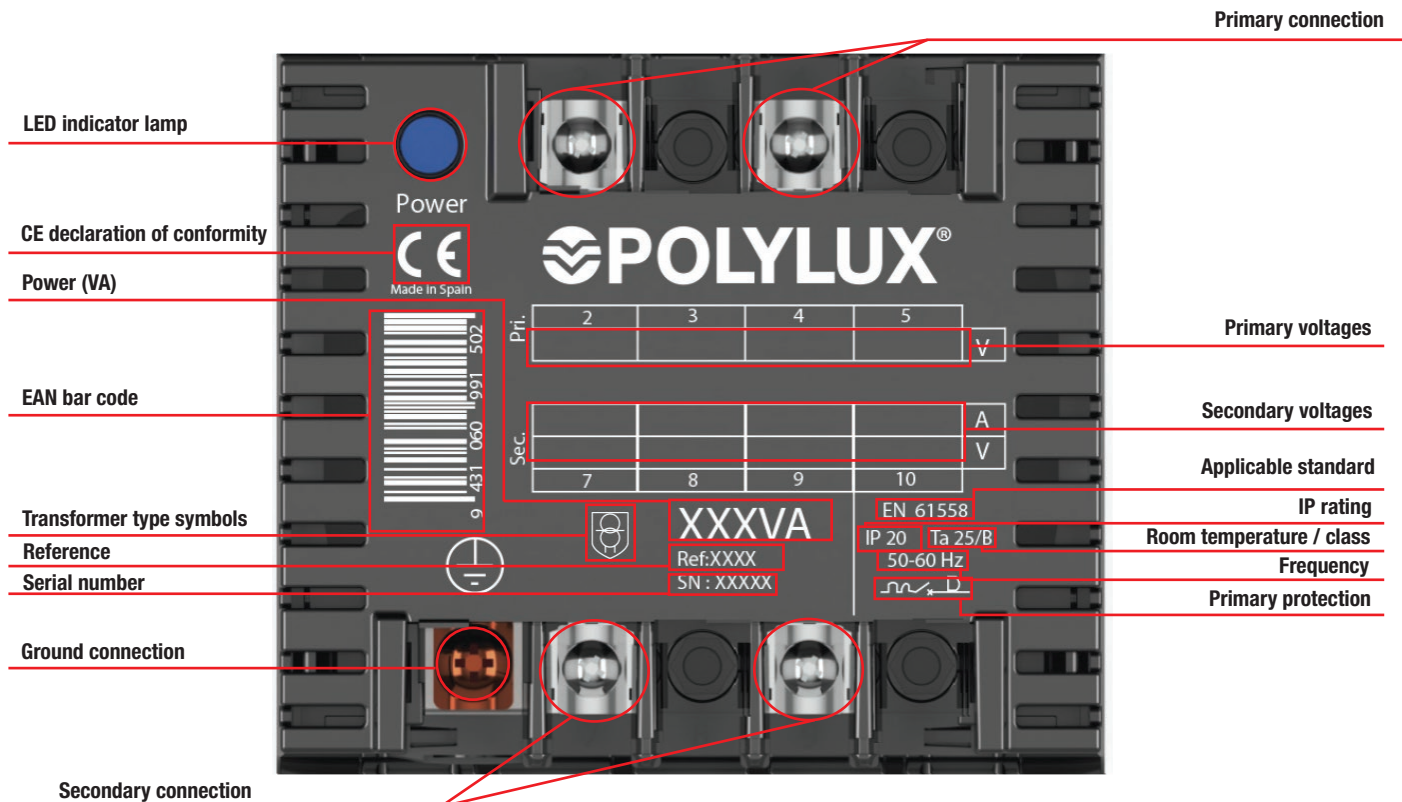



PIP SERIES

For spotlights in pools and gardens · Input **230 V** · Output **12 V** depending on the distance (see electrical connection)



Definition and applications

An isolation and safety voltage transformer with an output voltage of 12 V, fitted with a copper shield between primary and secondary, to provide complete safety for persons against electrical risks.

Its main applications are for pool and garden spotlights, and it can be used as a control and manoeuvre transformer in installations that pose a risk of electrical contact for persons.

Manufacturing characteristics

All the versions have the following features in common:

- **Important note:** copper shield between primary and secondary with connection to ground screw that prevents shunt voltage crossovers to the secondary circuit, thus posing no electrical risks for persons.
- Anti-flash dip varnishing. Ensures greater compactation, isolation and noise elimination.
- Connection terminals made of copper, welded and inserted in blocks to prevent hazards caused by expansion that may lead to poor connection.
- Bridges for the different connections included in the product packaging.
- Option of mounting on **DIN rail up to 300 VA**.
- IP20 enclosure, V-0 flame-retardant polymer box that complies with UL94.
- Safety Class I, convertible to Class II.
- Supplied with LED indicator lamp, electrostatic shield and adjustment through primary depending on the distance between the spotlight and the transformer (100 VA [10m, 20m, 30m] in 300 VA and 600 VA [10m, 25m, 40m]).
- All the transformers are checked automatically one by one and the compliance test report is created in accordance with the corresponding standard.



NEW head design

- Increased wiring insulation.
- Clearer features.
- Easier connection.
- More uniform, compact and robust design.

Technical features - standard model

Power	100 VA to 600 VA
Insulators	Class B - 130 °C
Winding	Class HC - 200 °C
Room temperature	45 °C
Frequency	50-60 Hz
Noise	≤ 45 dB
Protection rating	IP20
Cooling	ANAN
Includes	LED indicator lamp
Mounting	Mounting on DIN 46277/3 rail (up to 300 VA)
Standards	IEC/EN/UNE-EN 61558, CE
Protection	Convertible from Class I to Class II
Voltage selection	By means of metallic bridges, included (only for PIP600)
Operation	Continuous
Test voltage	3 kV (1 min., 50 Hz)

Electrical diagram

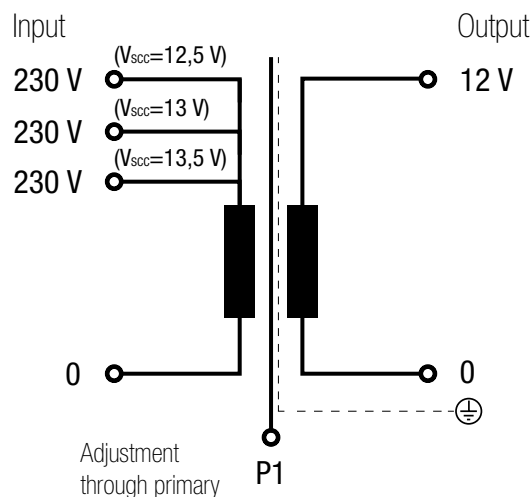



PIP SERIES

For spotlights in pools and gardens · Input **230 V** · Output **12 V** depending on the distance (see electrical connection)

Electrical connection

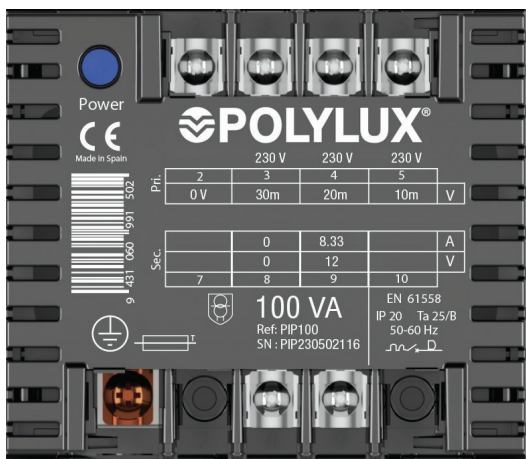

PIP100

Input:

- 230 V (distance between spotlight and transformer 30 metres) | Connection: 2-3
- 230 V (distance between spotlight and transformer 20 metres) | Connection: 2-4
- 230 V (distance between spotlight and transformer 10 metres) | Connection: 2-5

Output:

- 12 V | Connection: 8-9

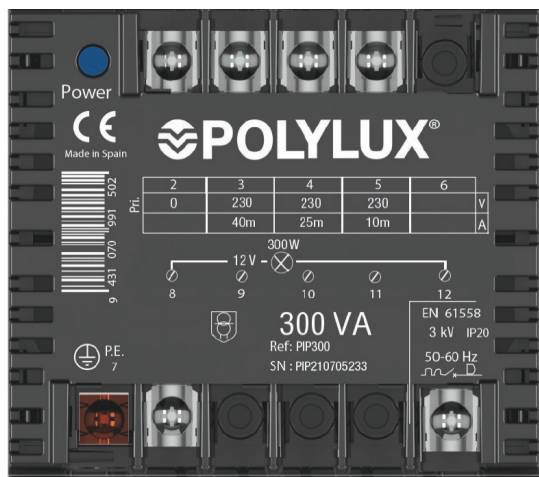

PIP300

Input:

- 230 V (distance between spotlight and transformer 40 metres) | Connection: 2-3
- 230 V (distance between spotlight and transformer 25 metres) | Connection: 2-4
- 230 V (distance between spotlight and transformer 10 metres) | Connection: 2-5

Output:

- 12 V | Connection: 8-12

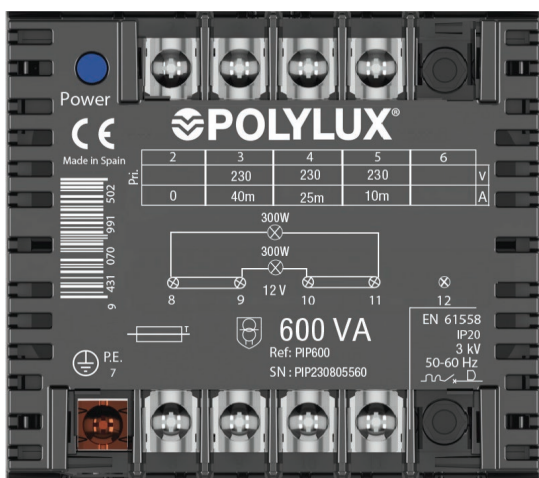

PIP600

Input:

- 230 V (distance between spotlight and transformer 40 metres) | Connection: 2-3
- 230 V (distance between spotlight and transformer 25 metres) | Connection: 2-4
- 230 V (distance between spotlight and transformer 10 metres) | Connection: 2-5

Output:

- For one spotlight:
 - 12 V | Connection: 9-10
- For two spotlights:
 - 12 V | Connection: 8-11
 - Bridges: 8-9 / 10-11





PIP SERIES

For spotlights in pools and gardens · Input **230 V** · Output **12 V** depending on the distance (see electrical connection)

Terminal types

Terminal blocks	Dimensions mm				Maximum tightening torque N·m	Primary Power VA		Secondary Power VA	
	A	B	C	Ø		From	To	From	To
	Terminal M3	8	11	9		M3	0.5	100	100
Terminal M4	10	13.5	12	M4	1.1	300	600	300	300
Terminal M5	15	18.5	14	M5	2.5	-	-	600	600

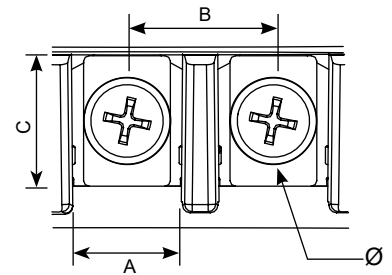

Theoretical data - standard model

Power VA	Reference	Input current A	Output current A			Maximum cross-section input conductor (mm²)		Maximum cross-section output conductor (mm²)		Input protections (A) (MCB -> D / Fuse -> aM)	Output protections (A) (MCB -> C / Fuse -> gG)
			13.5 V	13 V	12.5 V	Flexible	Rigid	Flexible	Rigid		
100	PIP100	0.43	8.3	8.3	8.3	0.5	1	2	2.5	1	8
300	PIP300	1.3	25	25	25	0.5	1	4	-	3	25
600	PIP600	2.6	50	50	50	1	1.5	10	-	10	50

Measurements

Power VA	Ref.	Output adjustment depending on distance V			External dimensions mm			Fastening elements mm			Weight kg
		13.5	13	12.5	A	B	C	D	E	Ø	
100	PIP100	30 m	20 m	10 m	84	101	98	88	55	5	1.6
300	PIP300	40 m	25 m	10 m	106	123	118	110	74	5	3.7
600	PIP600	40 m	25 m	10 m	136	162	156	145	104	6	6.8

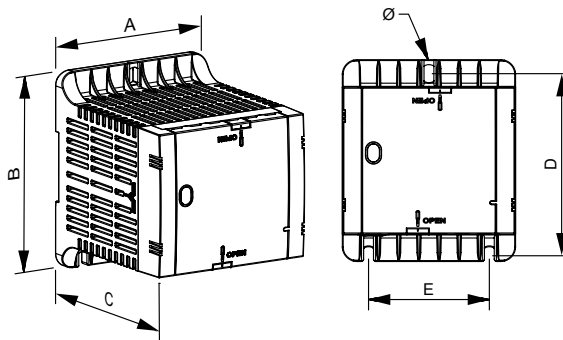



PIP SERIES

For spotlights in pools and gardens · Input **230 V** · Output **12 V** depending on the distance (see electrical connection)

Feature plate structure

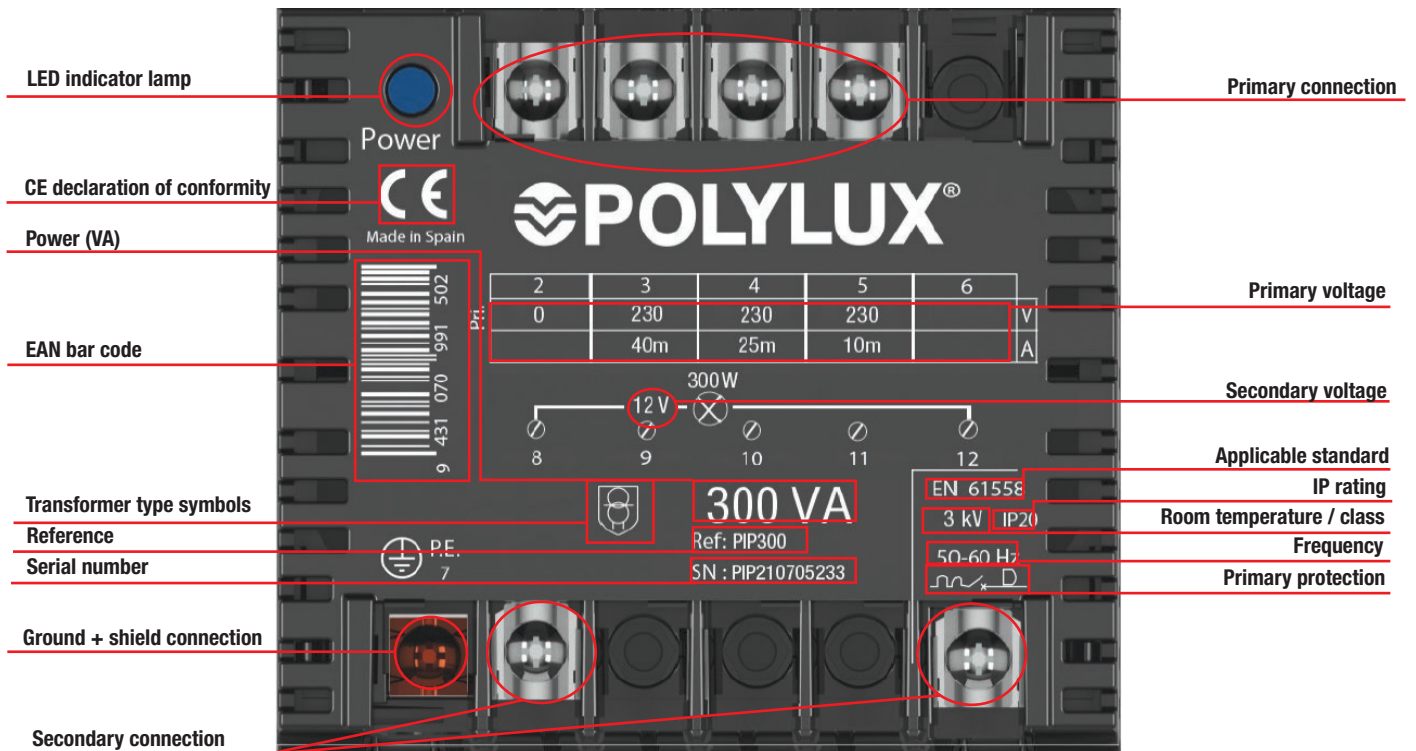



PIQ SERIES

For spotlights in pools and gardens · Input **230 V** · Output **12 V** depending on the distance (see electrical connection)



Definition and applications

An isolation and safety voltage transformer with an output voltage of 12 V, fitted with a copper shield between primary and secondary, to provide complete safety for persons against electrical risks.

Its main applications are spotlights in pools and gardens and it can be used as a control and manoeuvre transformer in installations that pose a risk of electrical contact for persons.

Manufacturing characteristics

All the versions have the following features in common:

- **Important note:** copper shield between primary and secondary with connection to ground screw that prevents shunt voltage crossovers to the secondary circuit, thus posing no electrical risks for persons.
- Encapsulated in flame retardant resin.
- Connection terminals made of copper, welded and inserted in blocks to prevent hazards caused by expansion that may lead to poor connection.
- Bridges for the different connections included in the product packaging.
- Option of mounting on **DIN rail up to 100 VA**.
- IP20 enclosure, V-0 flame-retardant polymer box that complies with UL94.
- All the live parts of these transformers are encapsulated in resin, which is particularly indicated for working in damp, saline and corrosive environments.
- They have greater resistance to current surges and transient harmonics.
- Greater mechanical resistance to vibrations and undesirable movements.
- Safety Class I, convertible to Class II.
- Supplied with LED indicator lamp, electrostatic shield and adjustment through primary depending on the distance between the spotlight and the transformer (100 VA [10m, 20m, 30m] in 300 VA and 600 VA [10m, 25m, 40m]).
- All the transformers are checked automatically one by one and the compliance test report is created in accordance with the corresponding standard.

NEW head design



- Increased wiring insulation.
- Clearer features.
- Easier connection.
- More uniform, compact and robust design.

Technical features - standard model

Power	100 VA to 600 VA
Insulators	Class B - 130 °C
Winding	Class HC - 200 °C
Room temperature	45 °C
Frequency	50-60 Hz
Noise	≤ 40 dB
Protection rating	IP20
Cooling	AN
Includes	LED indicator lamp
Mounting	Mounting on DIN 46277/3 rail (up to 100 VA)
Standards	IEC/EN/UNE-EN 61558, CE
Protection	Convertible from Class I to Class II
Voltage selection	By means of metallic bridges, included (only for PIQ600)
Operation	Continuous
Test voltage	3 kV (1 min., 50 Hz)

Electrical diagram

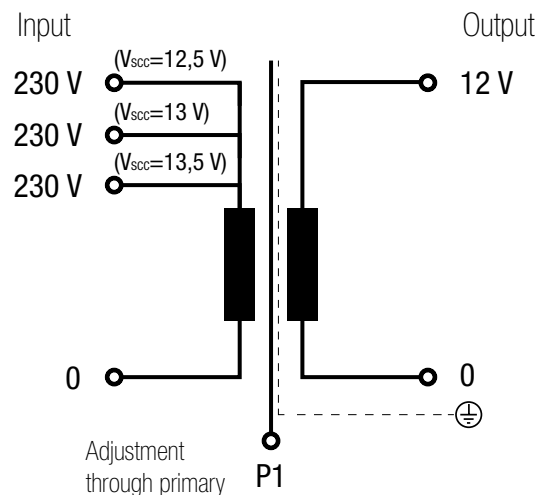



PIQ SERIES

For spotlights in pools and gardens · Input **230 V** · Output **12 V** depending on the distance (see electrical connection)

Electrical connection

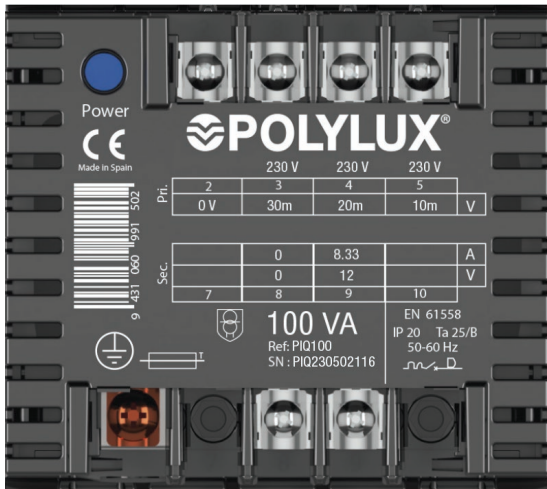

PIQ100

Input:

- 230 V (distance between spotlight and transformer 30 metres) | Connection: 2-3
- 230 V (distance between spotlight and transformer 20 metres) | Connection: 2-4
- 230 V (distance between spotlight and transformer 10 metres) | Connection: 2-5

Output:

- 12 V | Connection: 8-9

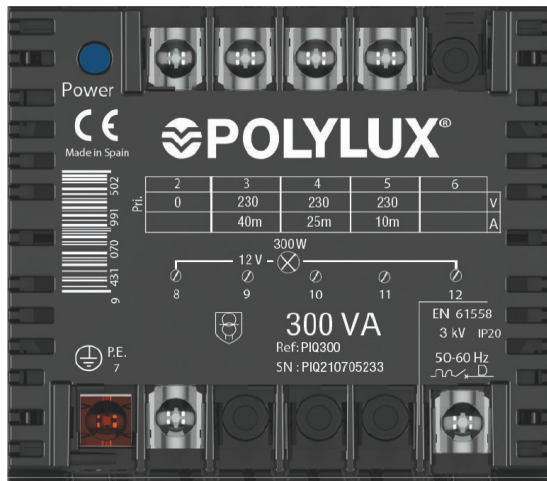

PIQ300

Input:

- 230 V (distance between spotlight and transformer 40 metres) | Connection: 2-3
- 230 V (distance between spotlight and transformer 25 metres) | Connection: 2-4
- 230 V (distance between spotlight and transformer 10 metres) | Connection: 2-5

Output:

- 12 V | Connection: 8-12

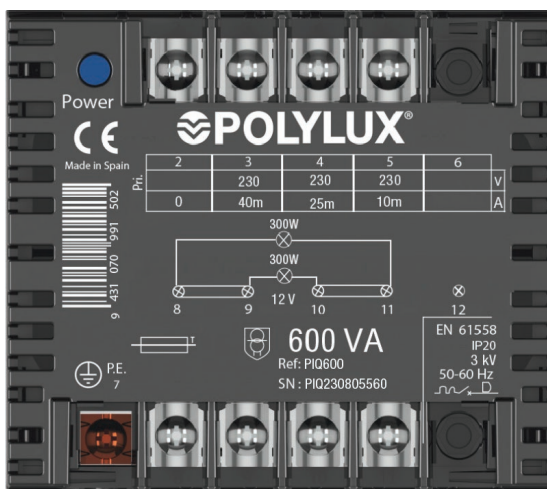

PIQ600

Input:

- 230 V (distance between spotlight and transformer 40 metres) | Connection: 2-3
- 230 V (distance between spotlight and transformer 25 metres) | Connection: 2-4
- 230 V (distance between spotlight and transformer 10 metres) | Connection: 2-5

Output:

- For one spotlight:
 - 12 V | Connection: 9-10
- For two spotlights:
 - 12 V | Connection: 8-11
 - Bridges: 8-9 / 10-11



PIQ SERIES

For spotlights in pools and gardens · Input **230 V** · Output **12 V** depending on the distance (see electrical connection)

Terminal types

Terminal blocks	Dimensions mm				Maximum tightening torque N-m	Primary Power VA		Secondary Power VA	
	A	B	C	Ø		From	To	From	To
	Terminal M3	8	11	9		M3	0.5	100	100
Terminal M4	10	13.5	12	M4	1.1	300	600	300	300
Terminal M5	15	18.5	14	M5	2.5	-	-	600	600

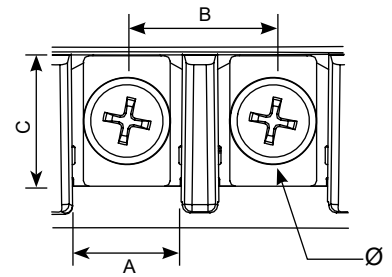

Theoretical data - standard model

Power VA	Reference	Input current A	Output current A			Maximum cross-section input conductor (mm²)		Maximum cross-section output conductor (mm²)		Input protections (A) (MCB -> D / Fuse -> aM)	Output protections (A) (MCB -> C / Fuse -> gG)
			13.5 V	13 V	12.5 V	Flexible	Rigid	Flexible	Rigid		
100	PIQ100	0.43	8.3	8.3	8.3	0.5	1	2	2.5	1	8
300	PIQ300	1.3	25	25	25	0.5	1	4	-	3	25
600	PIQ600	2.6	50	50	50	1	1.5	10	-	10	50

Measurements

Power VA	Ref.	Output adjustment depending on distance V			External dimensions mm			Fastening elements mm			Weight kg
		13.5	13	12.5	A	B	C	D	E	Ø	
100	PIQ100	30 m	20 m	10 m	84	101	98	88	55	5	1.7
300	PIQ300	40 m	25 m	10 m	106	123	118	110	74	5	4.1
600	PIQ600	40 m	25 m	10 m	136	162	156	145	104	6	7.8

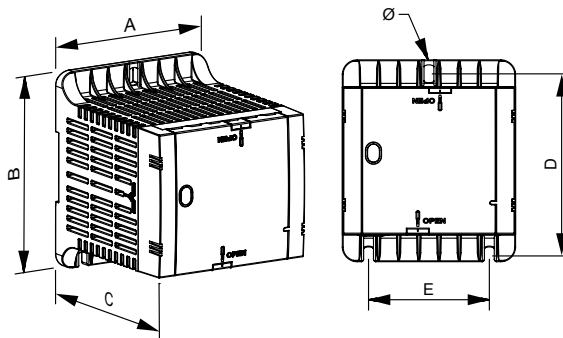



PIQ SERIES

For spotlights in pools and gardens · Input 230 V · Output 12 V depending on the distance (see electrical connection)

Feature plate structure

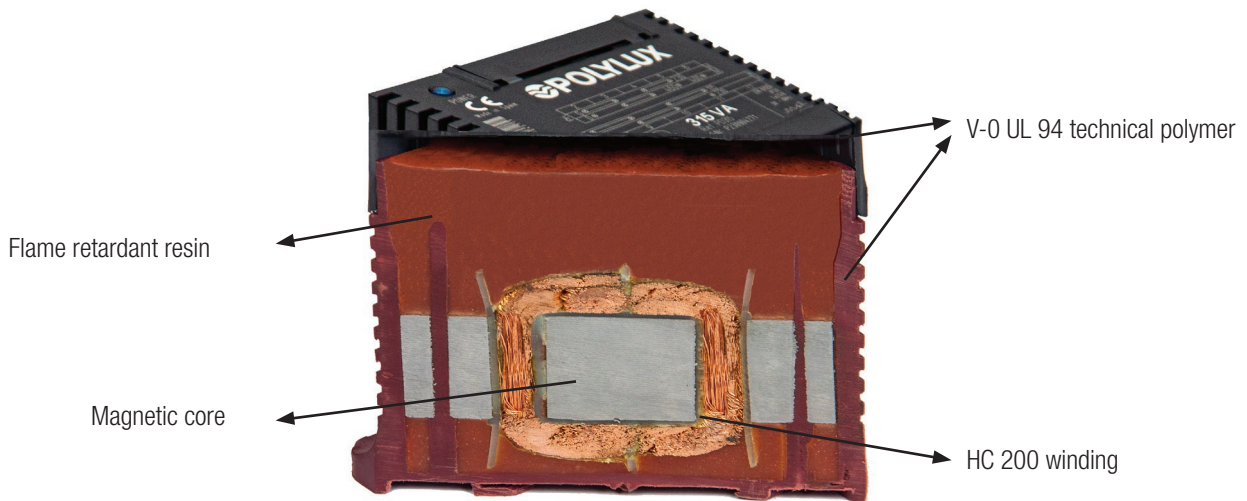
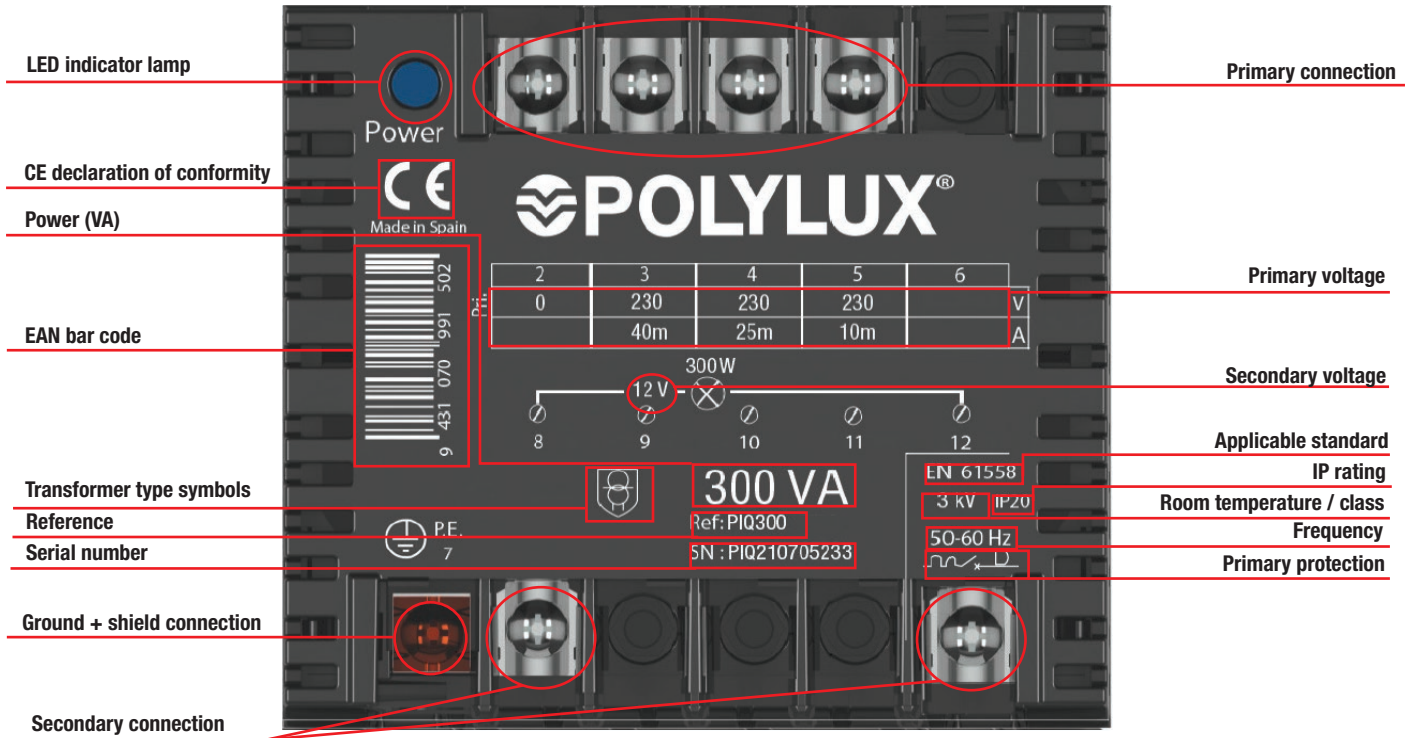

Sectioned transformer



PIN SERIES

For spotlights in pools and gardens · Input 230 V · Output 12 V depending on the distance (see electrical connection)



Technical features - standard model

Power	100 VA to 600 VA
Insulators	Class B - 130 °C
Winding	Class HC - 200 °C
Room temperature	45 °C
Frequency	50-60 Hz
Noise	≤ 45 dB
Protection rating	IP20
Cooling	AN
Mounting	Mounting on DIN 46277/3 rail (up to 100 VA)
Voltage selection	By means of metallic bridges, included (only for PIN600)
Standards	IEC/EN/UNE-EN 61558, CE
Operation	Continuous
Test voltage	3 kV (1 min., 50 Hz)

Definition and applications

An isolation and safety voltage transformer with an output voltage of 12 V, fitted with a copper shield between primary and secondary, to provide complete safety for persons against electrical risks.

Its main applications are spotlights in pools and gardens and it can be used as a control and manoeuvre transformer in installations that pose a risk of electrical contact for persons.

Manufacturing characteristics

All the versions have the following features in common:

- **Important note:** copper shield between primary and secondary with connection to ground screw that prevents shunt voltage crossovers to the secondary circuit, thus posing no electrical risks for persons.
- Connection terminals made of copper, welded and inserted in blocks to prevent hazards caused by expansion that may lead to poor connection.
- Bridges for the different connections included in the product packaging.
- Option of mounting on **DIN rail up to 300 VA**.
- All the transformers are checked automatically one by one and the compliance test report is created in accordance with the corresponding standard.

Electrical diagram

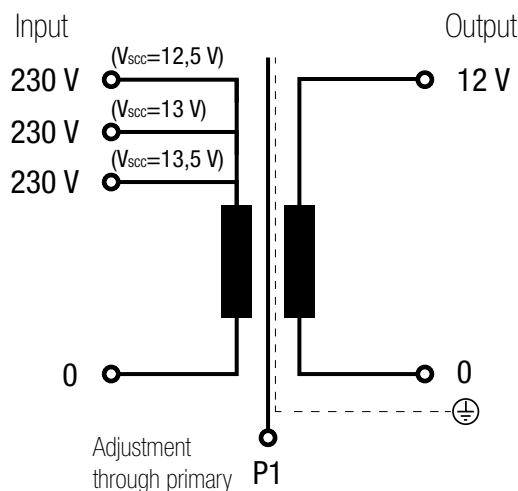



PIN SERIES

For spotlights in pools and gardens · Input **230 V** · Output **12 V** depending on the distance (see electrical connection)

Terminal types

Terminal blocks	Dimensions mm				Maximum tightening torque N-m	Primary Power VA		Secondary Power VA	
	A	B	C	Ø		From	To	From	To
	Terminal M4	9.7	16	10.1		M4	1.1	100	300
Terminal M5	15.5	21.5	15.6	M5	2.5	600	600	600	600

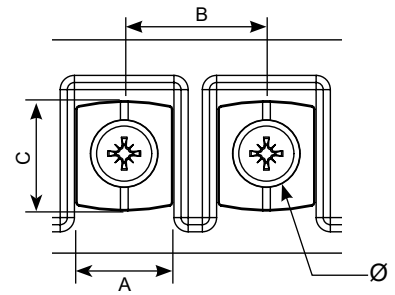

Theoretical data - standard model

Power VA	Reference	Input current A	Output current A			Maximum cross-section input conductor (mm²)		Maximum cross-section output conductor (mm²)		Input protections (A) (MCB -> D / Fuse -> aM)	Output protections (A) (MCB -> C / Fuse -> gG)
			13.5 V	13 V	12.5 V	Flexible	Rigid	Flexible	Rigid		
100	PIN100	0.43	8.3	8.3	8.3	0.5	1	2	2.5	1	8
300	PIN300	1.3	25	25	25	0.5	1	4	-	3	25
600	PIN600	2.6	50	50	50	1	1.5	10	-	10	50

Measurements

Power VA	Ref.	Output adjustment depending on distance V			External dimensions mm			Fastening elements mm			Weight kg
		13.5	13	12.5	A	B	C	D	E	Ø	
100	PIN100	30 m	20 m	10 m	75	96	100	80	56	6	1.8
300	PIN300	40 m	25 m	10 m	108	122	125	108	89	6	4.5
600	PIN600	40 m	25 m	10 m	126	145	167	125	102	7	9

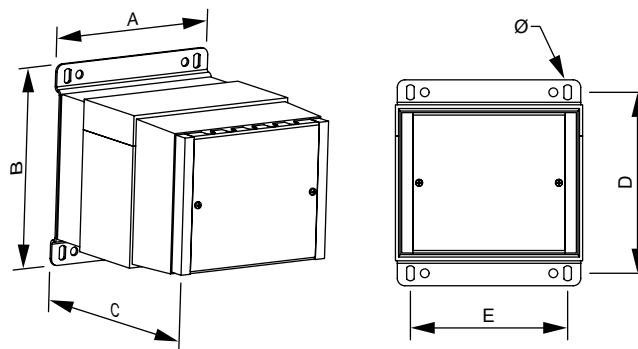



PIN SERIES

For spotlights in pools and gardens · Input **230 V** · Output **12 V** depending on the distance (see electrical connection)

Feature plate structure

Primary connection

Distances between spotlight and transformer

Transformer type symbol

CE declaration of conformity

Primary protection

Insulators

Serial number

IP rating

Test voltage

Electrostatic shield connection

Primary voltages

Power (VA)

Applicable standard

EAN bar code

Frequency

Reference number

Secondary voltage

Secondary connection

1 0 2 230 3 230 4 230 5 V

40m 25m 10m

POLYLUX 600 VA Made in Spain CE

EN 61558 3kV 50-60 Hz IP-20 12-130 10 230V 6A

Ref: PIN600 SN: XXXXXXXXX

300W 300W 12V 6 7 8 9 10 V



PIPZ SERIES

For spotlights in pools and gardens · Input **230 V** · Output **12 V** depending on distance (see electrical connection) · IP54



Definition and applications

An isolation and safety voltage transformer with an output voltage of 12 V, fitted with a copper shield between primary and secondary, to provide complete safety for persons against electrical risks.

Its main applications are spotlights in pools and gardens and it can be used as a control and manoeuvre transformer in installations that pose a risk of electrical contact for persons.

Manufacturing characteristics

All the versions have the following features in common:

- **Important note:** copper shield between primary and secondary with connection to ground screw that prevents shunt voltage crossovers to the secondary circuit, thus posing no electrical risks for persons.
- Anti-flash dip varnishing. Ensures greater compactation, isolation and noise elimination.
- Connection terminals made of copper, welded and inserted in blocks to prevent hazards caused by expansion that may lead to poor connection.
- Bridges for the different connections included in the product packaging.
- IP54 enclosure, epoxy polyester painted metal box.
- Safety Class I.
- All the transformers are checked automatically one by one and the compliance test report is created in accordance with the corresponding standard.

Technical features - standard model

Power	100 VA to 600 VA
Insulators	Class B - 130 °C
Winding	Class HC - 200 °C
Room temperature	45 °C
Frequency	50-60 Hz
Noise	≤ 45 dB
Enclosure colour	RAL 7035
Protection rating	IP54
Cooling	AN
Mounting	Hardware
Standards	IEC/EN/UNE-EN 61558, CE
Operation	Continuous
Test voltage	3 kV (1 min., 50 Hz)

Electrical diagram

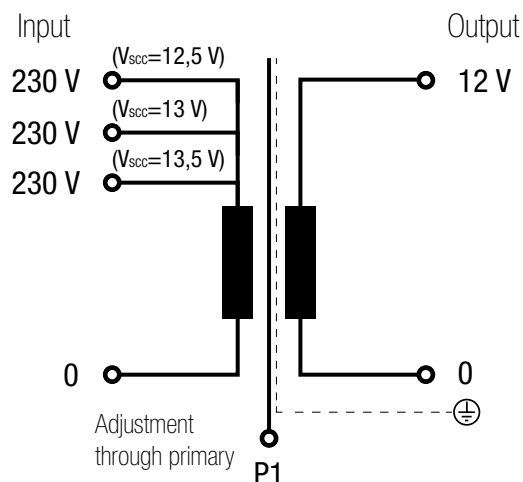



PIPZ SERIES

For spotlights in pools and gardens · Input **230 V** · Output **12 V** depending on distance (see electrical connection) · IP54

Electrical connection

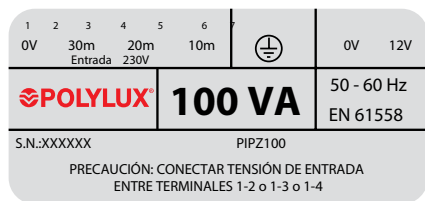

PIPZ100

Input:

- 230 V (distance between spotlight and transformer 30 metres) | Connection: 1-2
- 230 V (distance between spotlight and transformer 20 metres) | Connection: 1-3
- 230 V (distance between spotlight and transformer 10 metres) | Connection: 1-4

Output:

- 12 V | Connection: 6-7

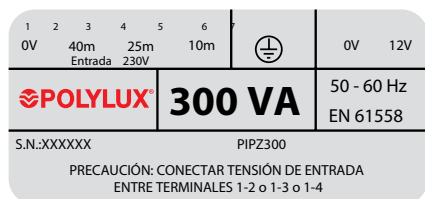

PIPZ300

Input:

- 230 V (distance between spotlight and transformer 40 metres) | Connection: 1-2
- 230 V (distance between spotlight and transformer 25 metres) | Connection: 1-3
- 230 V (distance between spotlight and transformer 10 metres) | Connection: 1-4

Output:

- 12 V | Connection: 6-7

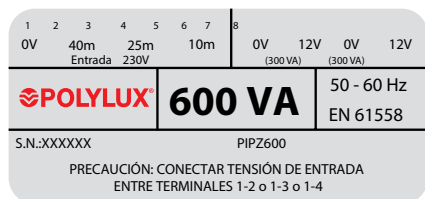

PIPZ600

Input:

- 230 V (distance between spotlight and transformer 40 metres) | Connection: 1-2
- 230 V (distance between spotlight and transformer 25 metres) | Connection: 1-3
- 230 V (distance between spotlight and transformer 10 metres) | Connection: 1-4

Output:

- 12 V | Connection: 5-6 or 7-8 (for one spotlight)
- 12 V | Connection: 5-6 and 7-8 (for two spotlights)

Terminal types

Terminal blocks	Dimensions mm				Maximum tightening torque N-m	Primary		Secondary	
	A	B	C	Ø		Power VA		Power VA	
						From	To	From	To
Terminal M3	8	11	9	M3	0.5	100	100	100	100
Terminal M4	10	13.5	12	M4	1.1	300	600	300	300
Terminal M5	15	18.5	14	M5	2.5	-	-	600	600

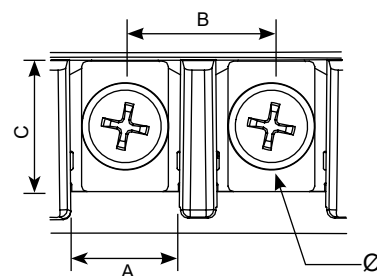

Theoretical data - standard model

Power VA	Reference	Input current A	Output current A			Maximum cross-section input conductor (mm²)		Maximum cross-section output conductor (mm²)		Input protections (A) (MCB -> D / Fuse -> aM)	Output protections (A) (MCB -> C / Fuse -> gG)
			13.5 V	13 V	12.5 V	Flexible	Rigid	Flexible	Rigid		
100	PIPZ100	0.43	8.3	8.3	8.3	0.5	1	2	2.5	1	8
300	PIPZ300	1.3	25	25	25	0.5	1	4	-	3	25
600	PIPZ600	2.6	50	50	50	1	1.5	10	-	10	50





PIPZ SERIES

For spotlights in pools and gardens · Input **230 V** · Output **12 V** depending on distance (see electrical connection) · IP54

Measurements

Power VA	Ref.	Output adjustment depending on distance V			External dimensions mm			Fastening elements mm			Weight kg
		13.5	13	12.5	A	B	C	D	E	Ø	
100	PIPZ100	30 m	20 m	10 m	140	95	165	123	120	6	3.9
300	PIPZ300	40 m	25 m	10 m	140	95	165	123	120	6	3.9
600	PIPZ600	40 m	25 m	10 m	190	120	215	174	160	6	11.9

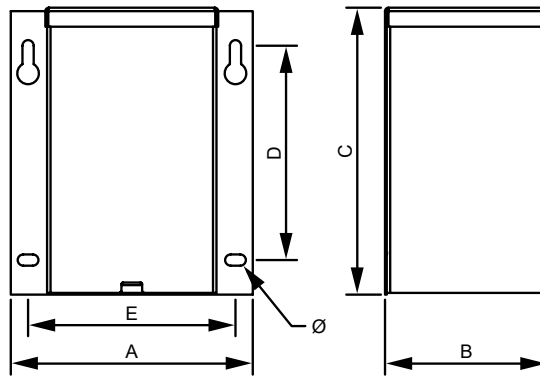

On-request manufacturing options (please see prices)

Power	From 100 VA to 600 VA
Protections	Primary fuse

Feature plate structure

Distances between spotlight and transformer

1 2 3 4 5 6 7

0V 40m 25m 10m

Input 230V

Ground connection

Secondary voltage 0V 12V

Primary voltage

POLYLUX® **300 VA**

50 - 60 Hz

Frequency

EN 61558

Applicable standard

S.N.:XXXXXX

PIPZ300

Reference

CAUTION: CONNECT INPUT VOLTAGE BETWEEN TERMINALS 1-2 or 1-3 or 1-4

IP SERIES

IP54 rated encapsulated isolation



Definition and applications

The IP transformers are used for the galvanic isolation of single-phase installations based on safety reasons and for the creation of neutrals referenced to ground. Their IP54 casings make the IP transformers the ideal solution for outdoor installations. The B version has 12V and 24V outputs and so it can be used in safety installations at voltages below 50 V with a high grade of protection or in outdoor installations. Furthermore, the resin encapsulation makes the IP transformers the perfect solution in cases that require high resistance to vibrations, damp or corrosion of the windings.

Manufacturing characteristics

The IPB and IPD models share the following characteristics:

- IP54 enclosure.
- Completely encapsulated in flame retardant resin.
- Protection against indirect contacts.
- Full power in all sockets.
- All the transformers are checked automatically one by one and the compliance test report is created in accordance with the corresponding standard.

Technical features - standard model

Power	100 VA to 2000 VA
Insulators	Class B - 130 °C
Winding	Class HC - 200 °C
Room temperature	45 °C
Frequency	50-60 Hz
Noise	≤ 45 dB
Protection rating	IP54
Cooling	AN
Mounting	With screws (for all powers)
Standards	IEC/EN/UNE-EN 61558, CE
Safety	Class I
Operation	Continuous
Test voltage	4.6 kV (1 min., 50 Hz) between primary and secondary 3.2 kV (1 min., 50 Hz) between primary and ground 2.5 kV (1 min., 50 Hz) between secondary and ground

Electrical diagram

- **Up to 100 VA**

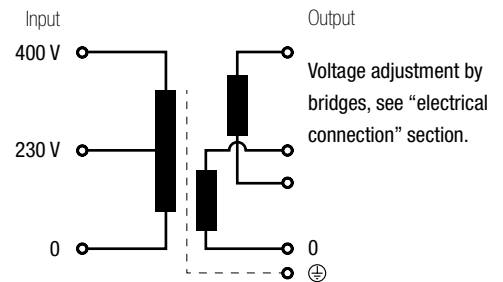

- **From 200 VA**

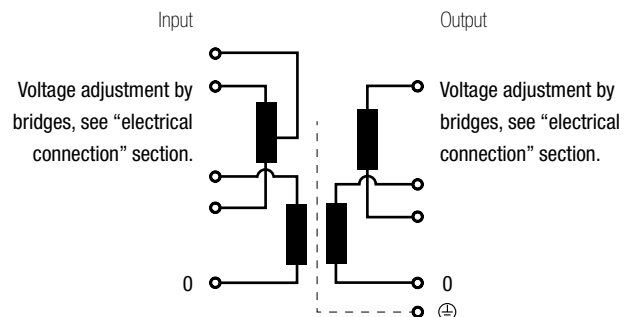



IP SERIES

IP54 rated encapsulated isolation

Electrical connection

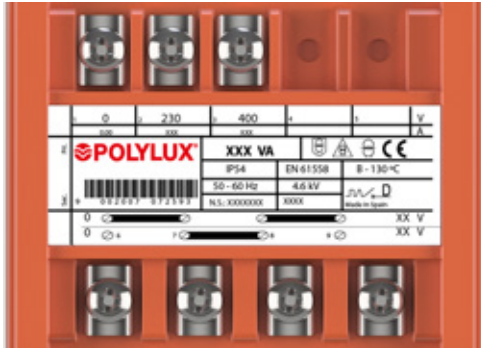

≤ 100 VA

Input:

- 230 V | Connection: 1-2
- 400 V | Connection: 1-3

Output:

- IPB 12 V | Connection: 7-9
- IPD 115 V | Bridges: 6-7 / 8-9
- IPB 24 V | Connection: 6-9
- IPD 230 V | Bridges: 7-8

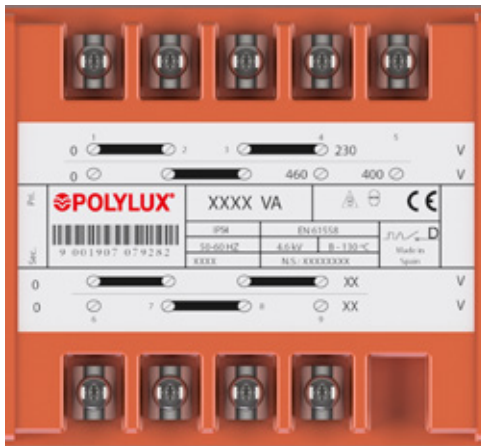

≥ 200 VA

Input:

- 230 V | Connection: 1-4
Bridges: 1-2 / 3-4
- 400 V | Connection: 1-5
Bridges: 2-3
- 460 V | Connection: 1-4
Bridges: 2-3

Output:

- IPB 12 V | Connection: 6-9
- IPD 115 V | Bridges: 6-7 / 8-9
- IPB 24 V | Connection: 6-9
- IPD 230 V | Bridges: 7-8

Terminal types

Terminal blocks	Dimensions mm				Maximum tightening torque N-m	Primary Power VA		Secondary Power VA	
	A	B	C	Ø		From	To	From	To
Terminal M4	9.7	16	10.1	M4	1.1	100	315	100	315
Terminal M5	15.5	21.5	15.6	M5	2.5	500	2000	500	2000

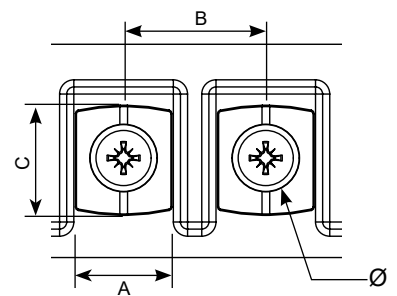

IP SERIES

IP54 rated encapsulated isolation



Theoretical data - standard model

Power VA	Reference	Input current A			Output current A		Input protections (A) (MCB -> D / Fuse -> aM)			Output protections (A) (MCB -> C / Fuse -> gG)	
		230 V	400 V	460 V	V1	V2	230 V	400 V	460 V	V1	V2
IPB (output voltage 12 V [V1] or 24 V [V2])											
100	IPB100	0.43	0.25	-	8.33	4.17	1 (-/T)	0.5 (-/T)	-	8	4
200	IPB200	0.87	0.50	0.43	16.67	8.33	2	1	1	16	8
315	IPB315	1.37	0.79	0.68	26.25	13.13	3.15	1.6	1.6	25	12.5
500	IPB500	2.17	1.25	1.09	41.67	20.83	5	2.5	2.5	40	20
630	IPB630	2.74	1.58	1.37	52.50	26.25	10	3	3	50	25
1000	IPB1000	4.35	2.50	2.17	83.33	41.67	10	6	6	80	40
1600	IPB1600	6.96	4.00	3.48	133.33	66.67	16	10	10	100	60
2000	IPB2000	8.70	5.00	4.35	166.67	83.33	20	10	10	150	80
IPD (output voltage 115 V [V1] or 230 V [V2])											
100	IPD100	0.43	0.25	-	0.87	0.43	1 (-/T)	0.5 (-/T)	-	0.8 (-/T)	0.4 (-/T)
200	IPD200	0.87	0.50	0.43	1.74	0.87	2	1	1	1.6	0.8 (-/T)
315	IPD315	1.37	0.79	0.68	2.74	1.37	3.15	1.6	1.6	2.5	1.25
500	IPD500	2.17	1.25	1.09	4.35	2.17	5	2.5	2.5	4	2
630	IPD630	2.74	1.58	1.37	5.48	2.74	10	3	3	5	2.5
1000	IPD1000	4.35	2.50	2.17	8.70	4.35	10	6	6	8	4
1600	IPD1600	6.96	4.00	3.48	13.91	6.96	16	10	10	12.5	6
2000	IPD2000	8.70	5.00	4.35	17.39	8.70	20	10	10	16	8

Power VA	Reference	Maximum cross-section input conductor (mm²)						Maximum cross-section output conductor (mm²)				Stuffing boxes	
		230 V		400 V		460 V		V1		V2		Input	Output
		Flexible	Rigid	Flexible	Rigid	Flexible	Rigid	Flexible	Rigid	Flexible	Rigid		
IPB (output voltage 12 V [V1] or 24 V [V2])													
100	IPB100	0.5	1	0.5	0.5	-	-	2	2.5	1.5	2	PG11	PG11
200	IPB200	0.5	1	0.5	1	0.5	1	4	-	2	2.5	PG11	PG16
315	IPB315	0.5	1	0.5	1	0.5	1	6	-	2.5	4	PG11	PG16
500	IPB500	1	1.5	0.5	1	0.5	1	10	-	4	-	PG16	PG21
630	IPB630	1	1.5	1	1.5	0.5	1	-	-	6	-	PG16	PG21
1000	IPB1000	1.5	2	1	1.5	1	1.5	-	-	10	-	PG21	PG29
1600	IPB1600	1.5	2	1	1.5	1	1.5	-	-	-	-	PG21	PG29
2000	IPB2000	2	2.5	1.5	2	1.5	2	-	-	-	-	PG21	PG29
IPD (output voltage 115 V [V1] or 230 V [V2])													
100	IPD100	0.5	1	0.5	0.5	-	-	0.5	1	0.5	1	PG11	PG11
200	IPD200	0.5	1	0.5	1	0.5	1	1	1.5	0.5	1	PG11	PG16
315	IPD315	0.5	1	0.5	1	0.5	1	1	1.5	0.5	1	PG11	PG16
500	IPD500	1	1.5	0.5	1	0.5	1	1.5	2	1	1.5	PG16	PG21
630	IPD630	1	1.5	1	1.5	0.5	1	1.5	2	1	1.5	PG16	PG21
1000	IPD1000	1.5	2	1	1.5	1	1.5	2	2.5	1.5	2	PG21	PG21
1600	IPD1600	1.5	2	1	1.5	1	1.5	2.5	4	1.5	2	PG21	PG21
2000	IPD2000	2	2.5	1.5	2	1.5	2	4	-	2	2.5	PG21	PG21



IP SERIES

IP54 rated encapsulated isolation



Measurements

Output voltage 12 / 24 V IPB									Output voltage 115 / 230 V IPD							
Power VA	Ref.	External dimensions mm			Fastening elements mm			Weight kg	Ref.	External dimensions mm			Fastening elements mm			Weight kg
		A	B	C	D	E	Ø			A	B	C	D	E	Ø	
100	IPB100	126	145	170	125	102	7	5.6	IPD100	126	145	170	125	102	7	5.6
200	IPB200	150	165	190	145	125	7	7.3	IPD200	150	165	190	145	125	7	7.3
315	IPB315	150	165	210	145	125	7	9.2	IPD315	150	165	210	145	125	7	9.2
500	IPB500	195	198	220	178	173	7	11.9	IPD500	195	198	220	178	173	7	11.9
630	IPB630	195	198	260	178	173	7	19.1	IPD630	195	198	260	178	173	7	19.1
1000	IPB1000	240	235	260	212	218	7	30.3	IPD1000	240	235	260	212	218	7	30.3
1600	IPB1600	260	272	310	250	238	7	47.3	IPD1600	260	272	310	250	238	7	41.9
2000	IPB2000	260	272	330	250	238	7	53	IPD2000	260	272	330	250	238	7	49.2

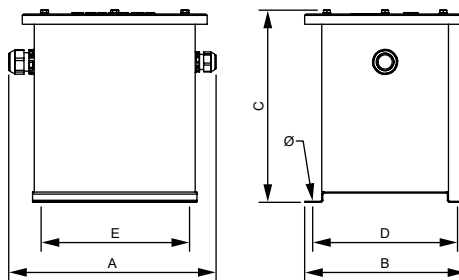

On-request manufacturing options (please see prices)

Power	From 100 VA to 2000 VA
Voltages	6 V to 1200 V
Shields	Primary / secondary, primary / ground and secondary / ground

Feature plate structure

Primary connection

Primary voltages

Transformer type symbols

CE declaration of conformity

Primary protection

Insulators

Secondary voltages

Serial number

Test voltage

Power (VA)

EAN bar code

IP rating

Frequency

Reference

Applicable standard

Secondary connection

TP SERIES

Encapsulated safety PCs · Input 230 V · Output 12 V (TPA) or 24 V (TPB)



Definition and applications

The TP transformers are portable transformers designed for use in supplying low voltage single-phase loads in places that are difficult to reach, or where there is no power socket.

In addition, the flame retardant resin encapsulation make the TP transformers the ideal solution for areas that require high resistance to vibrations, damp or corrosion. In outdoor installations where there are poor weather conditions, the high IP54 isolation protection rating also converts the TP transformers into the perfect solution for connecting low voltage appliances (spotlights, machinery, etc.) in damp places handled by personnel where there is a risk of electrocution.

Manufacturing characteristics

- Dry transformer encapsulated in flame retardant resin.
- Safety Class II.
- Indicator lamp included.
- Schuko input connection with 2 metre cable, CETAC output pins (160 VA 1 pin I 250 VA 2 pins I 400 VA and 630 VA 4 pins).
- Short circuit protection by means of a primary time-delay fuse.
- All the transformers are checked automatically one by one and the compliance test report is created in accordance with the corresponding standard.

Technical features - standard model

Power	160 VA to 630 VA
Insulators	Class B - 130 °C
Winding	Class HC - 200 °C
Room temperature	45 °C
Frequency	50-60 Hz
Noise	≤ 45 dB
Protection rating	IP54
Cooling	AN
Standards	IEC/EN/UNE-EN 61558, CE
Safety	Class II.
Operation	Continuous
Test voltage	3.5 kV (1 min., 50 Hz)

Electrical diagram

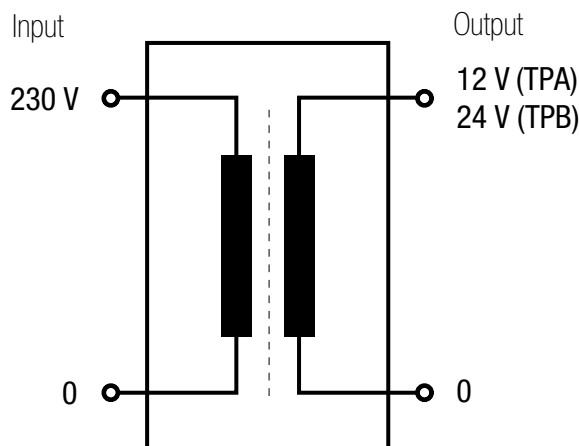

Theoretical data - standard model

Power VA	Reference	Input current A	Output current A
TPA (output voltage 12 V)			
160	TPA160	0.70	13.33
250	TPA250	1.09	20.83
400	TPA400	1.74	33.33
630	TPA630	2.74	52.50
TPB (output voltage 24 V)			
160	TPB160	0.70	6.67
250	TPB250	1.09	10.42
400	TPB400	1.74	16.67
630	TPB630	2.74	26.25

*Input cable length 2 metres.

TP SERIES

Encapsulated safety PCs · Input 230 V · Output 12 V (TPA) or 24 V (TPB)



Measurements

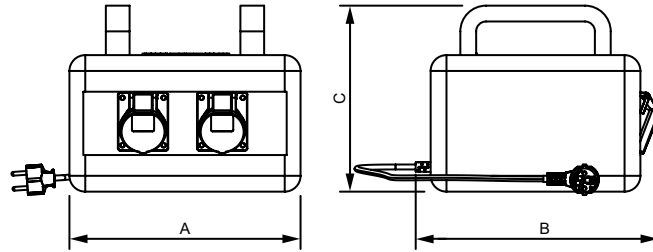

Output voltage 12 V TPA					Output voltage 24 V TPB					
Power VA	Ref.	Dimensions mm			Weight kg	Ref.	Dimensions mm			Weight kg
		A	B	C			A	B	C	
160	TPA160	210	170	160	6.8	TPB160	210	200	160	6.8
250	TPA250	215	200	180	10	TPB250	215	210	180	10
400	TPA400	245	265	235	16.1	TPB400	245	300	235	16.1
630	TPA630	245	265	235	20.5	TPB630	245	300	235	20.5

On-request manufacturing options (please see prices)

Pins	Different types
Cables	Neoprene

Feature plate structure

Protection Class II. (Symbol: square with a lightning bolt)

CE declaration of conformity (Symbol: CE mark)

Power (VA): XXX VA

Reference: TPXXXX

Frequency: 50 - 60 Hz

Isolation transformer symbol (Symbol: transformer with lightning bolt)

Fuse: Fus.:6A aM

Serial number: SN: TPXXXXXX

Primary voltage: 230 V

Primary current: XXX A

Secondary voltage: XX V

Secondary current: XXX A

IP rating: IP54

Applicable standard: EN 61558

EAN bar code: 9 638 456 958 502

Test voltage: 3.5kV

Insulators: B-130°C



PTM SERIES

For measuring equipment



Definition and applications

The function of a measuring transformer is to provide a precise output voltage, isolating it from the input voltage. Firstly, it reduces the voltage to a lower value and secondly, it isolates the high voltage circuit from the measuring circuit.

Manufacturing characteristics

All the versions have the following features in common:

- Anti-flash dip varnishing. Ensures greater compactation, isolation and noise elimination.
- IP20 enclosure with next-generation V-0 flame retardant polymer box in accordance with UL94.
- Connection terminals made of copper, welded and inserted in blocks to prevent hazards caused by expansion that may lead to poor connection.
- Option of mounting on **DIN rail up to 7.5 VA**.
- Precision classes 0.2 / 0.5 / 1 based on power.
- Accepts a continuous surge current of 1.2 times the nominal voltage and a thermal power 6 times the nominal power.
- All the transformers are checked automatically one by one and the compliance test report is created in accordance with the corresponding standard.

NEW head design

- Increased wiring insulation.
- Clearer features.
- Easier connection.
- More uniform, compact and robust design.



Technical features - standard model

Power	2 VA to 300 VA (class 0.2 / 0.5 / 1)
Insulators	Class B - 130 °C
Winding	Class HC - 200 °C
Room temperature	45 °C
Frequency	50-60 Hz
Noise	≤ 45 dB
Protection rating	IP20
Cooling	ANAN
Includes	LED indicator lamp
Mounting	With screws (for all powers) Mounted on DIN 46277/3 rail (up to 7.5 VA)
Standards	IEC/EN/UNE-EN 61869-3, CE
Protection	Convertible from Class I to Class II
Operation	Continuous
Test voltage	3 kV (1 min., 50 Hz)

Electrical diagram

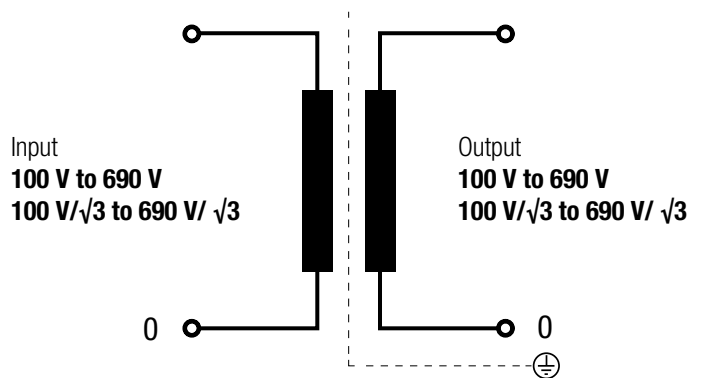

*For three-phase measuring transformers see page 73.





PTM SERIES

For measuring equipment

Terminal types

Terminal blocks	Dimensions mm				Maximum tightening torque N-m	Primary Power VA		Secondary Power VA	
	A	B	C	Ø		From	To	From	To
	Terminal M4	10	13.5	12		M4	1.1	2	150 (Class 1)
Terminal M5	15	18.5	14	M5	2.5	100 (Class 0.2)	300 (Class 1)	5 (Class 0.2)	150 (Class 1)
Terminal M6	15.5	20.4	13	M6	4	-	-	100 (Class 0.2)	300 (Class 1)

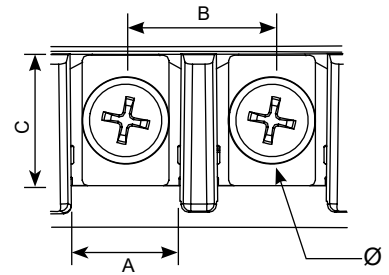

Measurements

Power VA			Ref.	External dimensions mm			Fastening elements mm			Weight kg
Class 0.2	Class 0.5 (3P)	Class 1 (6P)		A	B	C	D	E	Ø	
2	5	7.5	PTM50	106	123	118	110	74	5	2.3
5	10	15	PTM51	118	138	131	121	88	6	4.1
10	15	25	PTM52	118	138	131	121	88	6	4.1
15	30	50	PTM53	136	162	156	145	104	6	5.8
30	50	75	PTM55	136	162	156	145	104	6	6.8
50	75	100	PTM57	136	162	156	145	104	6	8.6
75	100	150	PTM510	136	162	180	145	104	6	10
100	150	200	PTM515	214	225	284	195	175	7	22
150	200	300	PTM520	214	225	284	195	175	7	27.6

Up to PTM510

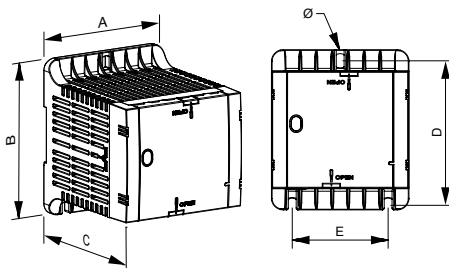

From PTM515

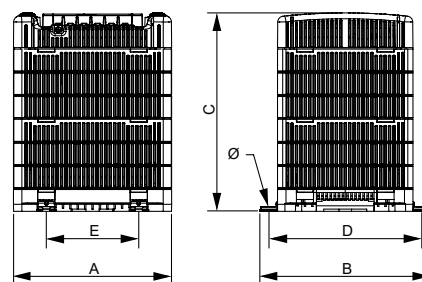

On-request manufacturing options (please see prices)

Power	From 2 VA to 300 VA
Output	Option of 3 outputs
Mounting	Option of mounting 3 transformers for a three-phase system (or see page 73)
Temperature	Up to 60 °C
Shields	Primary / secondary



PTM SERIES

For measuring equipment

Feature plate structure

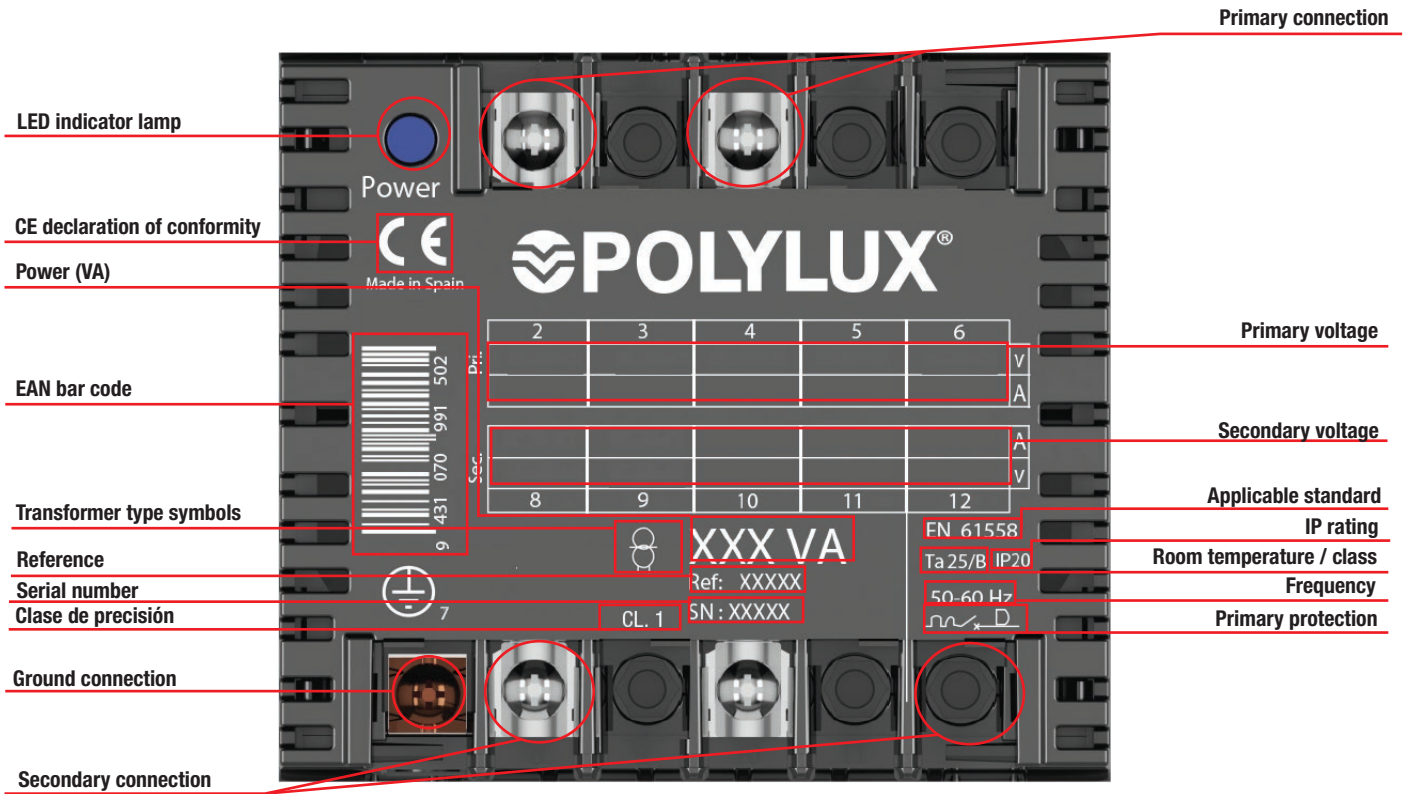



QTM SERIES

Encapsulated for measuring equipment



Definition and applications

The function of a measuring transformer is to provide a precise output voltage, isolating it from the input voltage. Firstly, it reduces the voltage to a lower value and secondly, it isolates the high voltage circuit from the measuring circuit.

Manufacturing characteristics

All the versions have the following features in common:

- Encapsulated in flame retardant resin.
- Connection terminals made of copper, welded and inserted in blocks to prevent hazards caused by expansion that may lead to poor connection.
- IP20 enclosure, V-0 flame-retardant polymer box that complies with UL94.
- All the live parts of these transformers are encapsulated in resin, which is particularly indicated for working in damp, saline and corrosive environments.
- They have greater resistance to current surges and transient harmonics.
- Greater mechanical resistance to vibrations and undesirable movements.
- Safety Class I, convertible to Class II.
- LED indicator lamp included.
- Precision classes 0.2 / 0.5 / 1 based on power.
- Accepts a continuous surge current of 1.2 times the nominal voltage and a thermal power 6 times the nominal power.
- All the transformers are checked automatically one by one and the compliance test report is created in accordance with the corresponding standard.

NEW head design

- Increased wiring insulation.
- Clearer features.
- Easier connection.
- More uniform, compact and robust design.



Technical features - standard model

Power	2 VA to 150 VA (class 0.2 / 0.5 / 1)
Insulators	Class B - 130 °C
Winding	Class HC - 200 °C
Room temperature	45 °C
Frequency	50-60 Hz
Noise	≤ 40 dB
Protection rating	IP20
Cooling	AN
Includes	LED indicator lamp
Mounting	With screws
Standards	IEC/EN/UNE-EN 61869-3, CE
Protection	Convertible from Class I to Class II
Operation	Continuous
Test voltage	3 kV (1 min., 50 Hz)

Electrical diagram

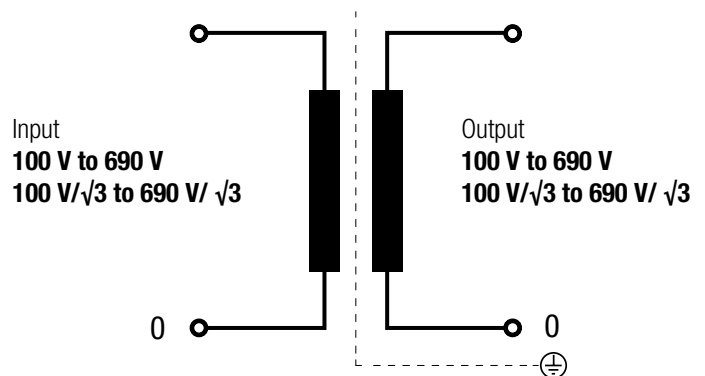



QTM SERIES

Encapsulated for measuring equipment

Terminal types

Terminal blocks	Dimensions mm				Maximum tightening torque N-m	Primary Power VA		Secondary Power VA	
	A	B	C	Ø		From	To	From	To
	Terminal M4	10	13.5	12		M4	1.1	2	150 (Class 1)
Terminal M5	15	18.5	14	M5	2.5	100 (Class 0.2)	300 (Class 1)	5 (Class 0.2)	150 (Class 1)
Terminal M6	15.5	20.4	13	M6	4	-	-	100 (Class 0.2)	300 (Class 1)

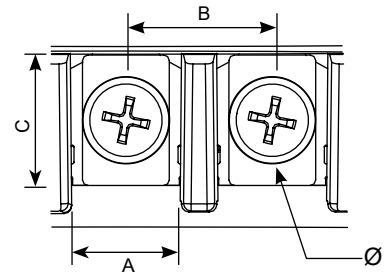

Measurements

Power VA			Ref.	External dimensions mm			Fastening elements mm			Weight kg
Class 0.2	Class 0.5 (3P)	Class 1 (6P)		A	B	C	D	E	Ø	
2	5	7.5	QTM50	106	123	118	110	74	5	2.6
5	10	15	QTM51	118	138	131	121	88	6	4.6
10	15	25	QTM52	118	138	131	121	88	6	4.6
15	30	50	QTM53	136	162	156	145	104	6	6.7
30	50	75	QTM55	136	162	156	145	104	6	7.8
50	75	100	QTM57	136	162	156	145	104	6	9.9
75	100	150	QTM510	136	162	180	145	104	6	11.5
100	150	200	QTM515	233	241	244	219	175	7	25.6
150	200	300	QTM520	233	241	274	219	175	7	30

Up to QTM510

From QTM515

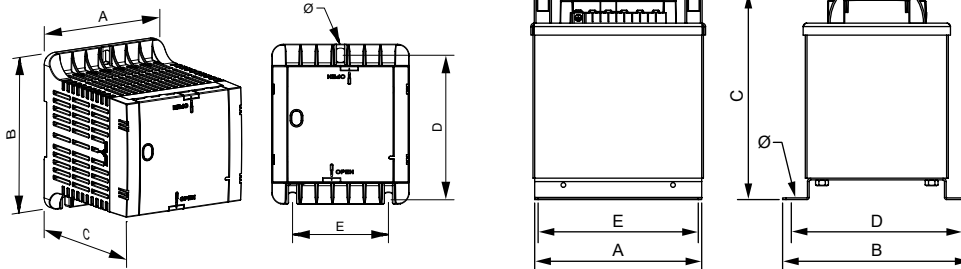

On-request manufacturing options (please see prices)

Power	From 2 VA to 300 VA
Output	Option of 3 outputs
Mounting	Option of mounting 3 transformers for a three-phase system (or see page 73)
Temperature	Up to 60 °C
Shields	Primary / secondary





QTM SERIES

Encapsulated for measuring equipment

Feature plate structure

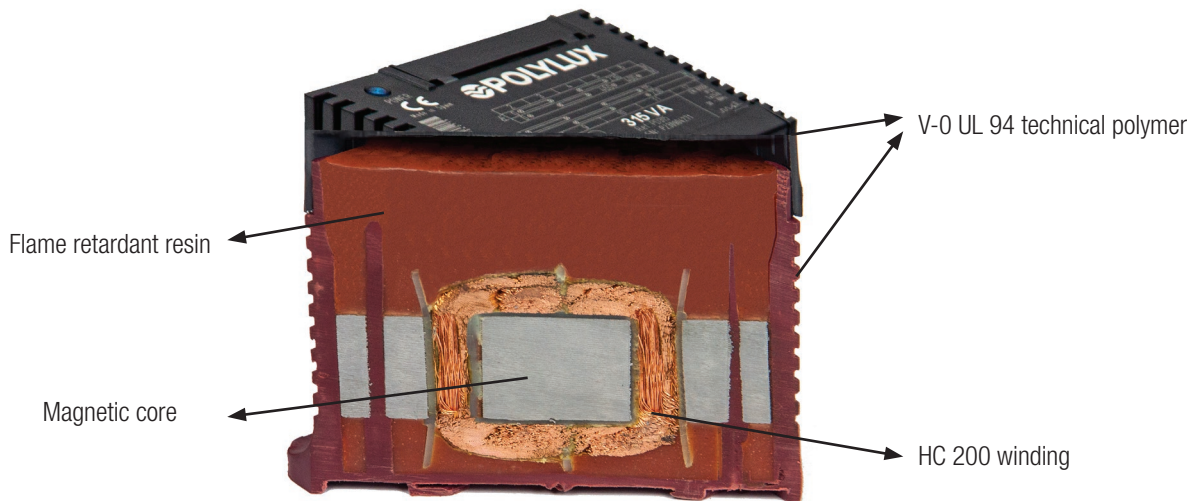
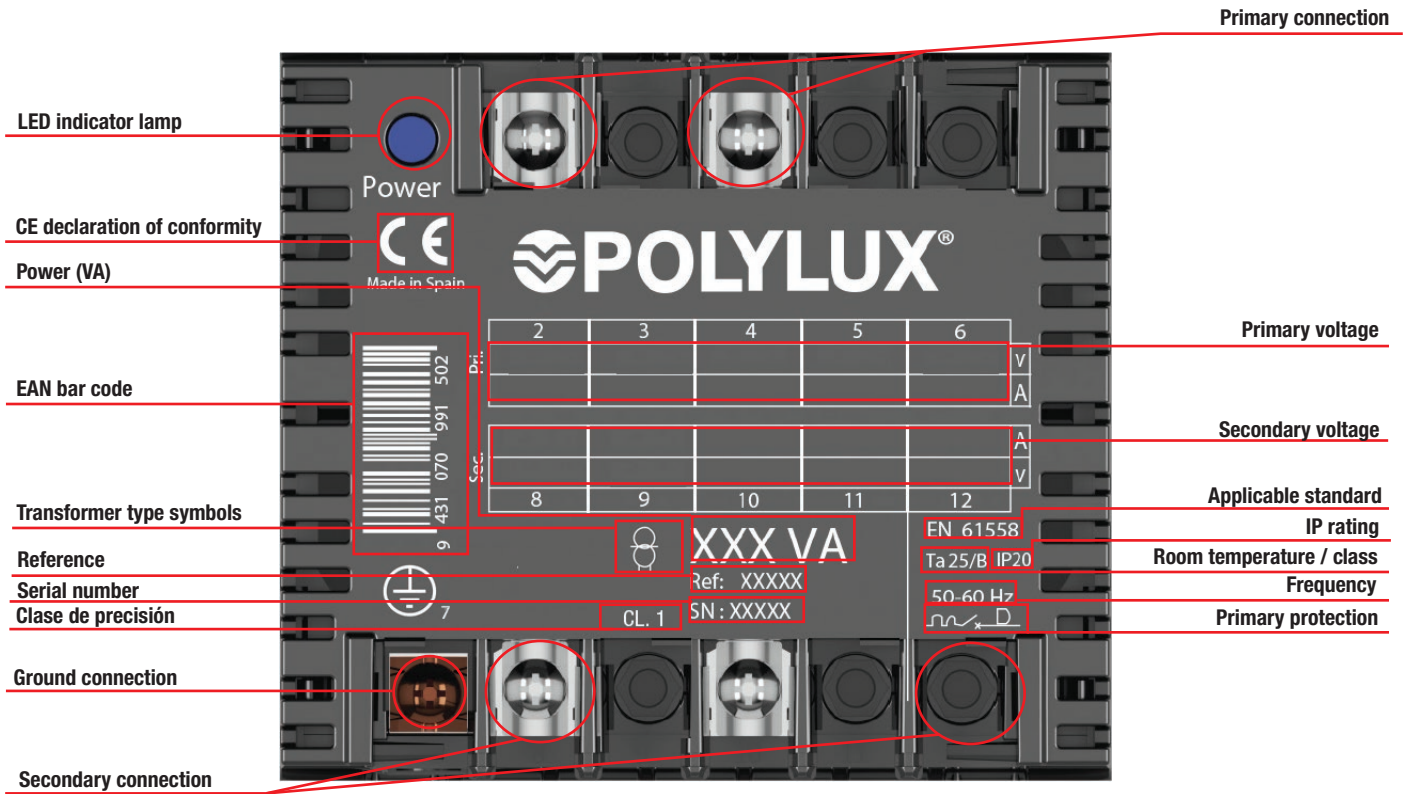

Sectioned transformer



TM SERIES

Encapsulated for measuring equipment



Technical features - standard model

Power	2 VA to 300 VA (class 0.2 / 0.5 / 1)
Insulators	Class B - 130 °C
Winding	Class HC - 200 °C
Room temperature	45 °C
Frequency	50-60 Hz
Noise	≤ 45 dB
Protection rating	IP20
Cooling	AN
Mounting	With screws (for all powers) Mounted on DIN 46277/3 rail (up to 7.5 VA)
Standards	IEC/EN/UNE-EN 61869-3, CE
Operation	Continuous
Test voltage	3 kV (1 min., 50 Hz)

Definition and applications

The function of a measuring transformer is to provide a precise output voltage, isolating it from the input voltage. Firstly, it reduces the voltage to a lower value and secondly, it isolates the high voltage circuit from the measuring circuit.

Manufacturing characteristics

All the versions have the following features in common:

- Connection terminals made of copper, welded and inserted in blocks to prevent hazards caused by expansion that may lead to poor connection.
- Option of mounting on **DIN rail up to 7.5 VA**.
- Encapsulated in flame retardant resin.
- All the live parts of these transformers are encapsulated in resin, which is particularly indicated for working in damp, saline and corrosive environments.
- They have greater resistance to current surges and transient harmonics.
- Greater mechanical resistance to vibrations and undesirable movements.
- Precision classes 0.2 / 0.5 / 1 based on power.
- Accepts a continuous surge current of 1.2 times the nominal voltage and a thermal power 6 times the nominal power.
- All the transformers are checked automatically one by one and the compliance test report is created in accordance with the corresponding standard.

Electrical diagram

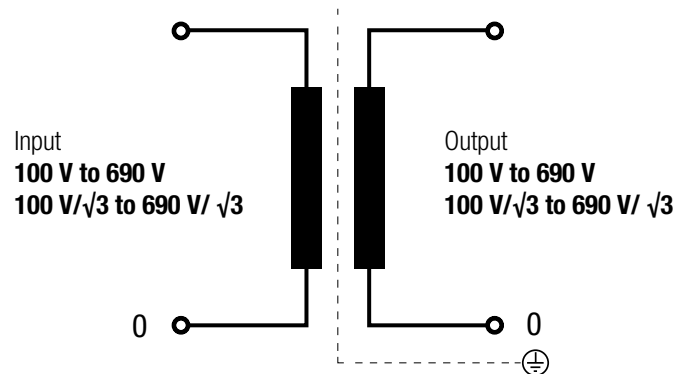



TM SERIES

Encapsulated for measuring equipment

Terminal types

Terminal blocks	Dimensions mm				Maximum tightening torque N-m	Primary Power VA		Secondary Power VA	
	A	B	C	∅		From	To	From	To
	Terminal M4	9.7	16	10.1		M4	1.1	2	25 (Class 1)
Terminal M5	15.5	21.5	15.6	M5	2.5	15 (Class 0.2)	300 (Class 1)	15 (Class 0.2)	150 (Class 1)

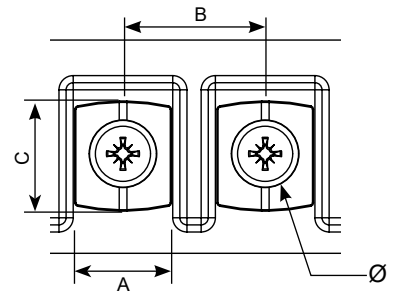

Measurements

Power VA			Ref.	External dimensions mm			Fastening elements mm			Weight kg
Class 0.2	Class 0.5 (3P)	Class 1 (6P)		A	B	C	D	E	∅	
2	5	7.5	TM50	96	112	116	96	77	6	3.7
5	10	15	TM51	108	122	125	106	89	6	4.7
10	15	25	TM52	108	122	135	106	89	6	5.4
15	30	50	TM53	126	145	147	125	102	7	7.1
30	50	75	TM55	126	145	167	125	102	7	9.1
50	75	100	TM57	126	145	177	125	102	7	10.3
75	100	150	TM510	150	165	180	145	125	7	13.3
100	150	200	TM515	150	165	190	145	125	7	14.8
150	200	300	TM520	150	165	210	145	125	7	16.9

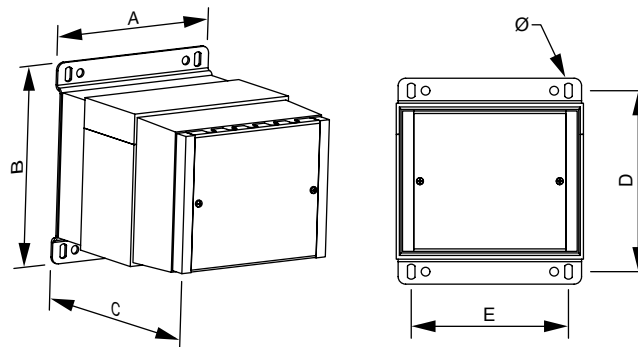

On-request manufacturing options (please see prices)

Power	From 2 VA to 300 VA
Output	Option of 3 outputs
Mounting	Option of mounting 3 transformers for a three-phase system (or see page 73)
Temperature	Up to 60 °C
Shields	Primary / secondary



TM SERIES

Encapsulated for measuring equipment

Feature plate structure

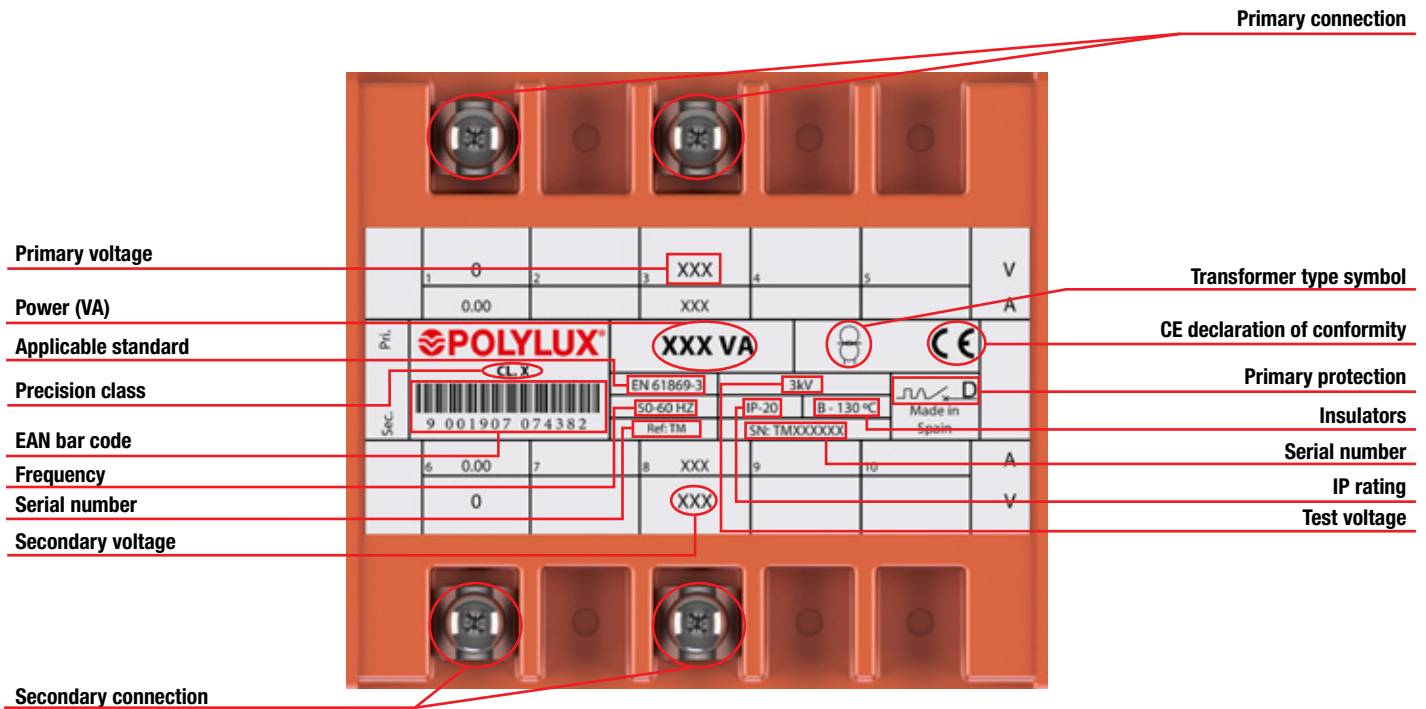



TMT SERIES

For adapting the voltage in measuring equipment

Definition and applications

The function of a measuring transformer is to provide a precise output voltage, isolating it from the input voltage. Firstly, it reduces the voltage to a lower high precision value and secondly, it isolates the high voltage circuit from the measuring circuit.

Manufacturing characteristics

- Built with independent circuits for the three phases to obtain a perfect balance between them and guarantee precision in measuring.
- Connection terminals made of copper, welded and inserted in blocks to prevent hazards caused by expansion that may lead to poor connection.
- LED indicator lamp (TMTW - TMTE).
- All the transformers are checked automatically one by one and the compliance test report is created in accordance with the corresponding standard.

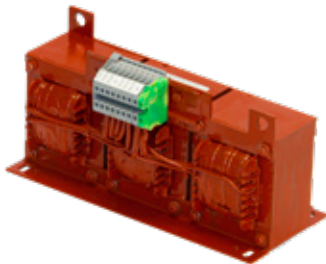

TMTX

- IP00 protection rating.
- Total impregnated in anti-flash varnish.
- Hoisting elements included.



TMTW

- IP20 protection rating.
- Epoxy painted metal box resistant to all types of damp and corrosive environments.
- Protective cover for terminals to prevent direct contact.



TMTE

- **Encapsulated in flame retardant resin.**
- IP20 protection rating.
- Protection against damp, saline and corrosive environments.
- Protective cover for terminals to prevent direct contact.
- Greater resistance to surge currents.
- Greater resistance to transient harmonics.
- Greater mechanical resistance to undesirable vibrations.
- Uniform heat dissipation.

Electrical diagram

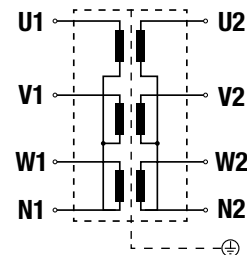

Technical features - standard model

Power	15 VA to 400 VA
Standard frequency	50-60 Hz
Noise	≤ 45 dB
Connection unit	YNyn0
Windings	Class HC-200 °C
Insulators	Class B - 130 °C <small>*More information in Technical Appendix (T.A.1)</small>
Class	I
IP rating	IP00 (TMTX) IP20 (TMTW - TMTE)
Room temperature	45 °C
Standards	IEC/EN/UNE-EN 61869-3, CE
Test voltage	3 kV (1 min., 50 Hz)
Inrush	≤ 5 In
Operation	Continuous
Cooling	AN (TMTX - TMTE) - ANAN (TMTW)
Hoisting accessories	Hoisting elements

Connection

• For TMTX

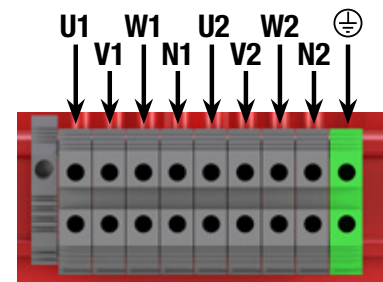

• For TMTW and TMTE





TMT SERIES

For adapting the voltage in measuring equipment

Terminal types

Terminals		Maximum cross-section conductor mm ²	Maximum tightening torque		TMTX		TMTW-TMTE	
			N·m	Lb·In	Power VA		Power VA	
				From	To	From	To	
Power strip 1	Terminal 4	6	0.5	4.4	15	400	-	-
Power strip 2	Terminal M5 (primary)	19	2.5	22.1	-	-	15	400
	Terminal M6 (secondary)	21	4	35.4	-	-	15	400

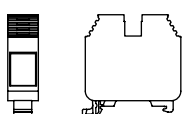

Power strip 1

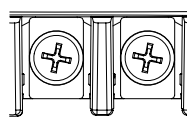

Power strip 2

Measurements

TMTX								TMTW								TMTE							
Ref.	External dimensions mm			Fastening elements mm			Weight kg	Ref.	External dimensions mm			Fastening elements mm			Weight kg	Ref.	External dimensions mm			Fastening elements mm			Weight kg
	A	B	C	D	E	Ø			A	B	C	D	E	Ø			A	B	C	D	E	Ø	
TMTX51	280	130	145	90	255	6	13.3	TMTW51	350	200	170	170	325	6	15.3	TMTE51	350	200	170	170	325	6	21.1
TMTX52	280	140	145	100	255	6	13.9	TMTW52	350	200	170	170	325	6	15.9	TMTE52	350	200	170	170	325	6	20.9
TMTX53	325	130	160	90	295	6	18.4	TMTW53	350	200	170	170	325	6	20.4	TMTE53	350	200	170	170	325	6	25
TMTX55	325	150	160	110	295	6	21.4	TMTW55	350	200	170	170	325	6	23.4	TMTE55	350	200	170	170	325	6	27
TMTX57	325	160	160	120	295	6	26.8	TMTW57	350	200	170	170	325	6	28.8	TMTE57	350	200	170	170	325	6	31.9
TMTX510	325	170	160	130	295	6	31	TMTW510	350	200	170	170	325	6	33	TMTE510	350	200	170	170	325	6	35.6

TMTX IP00

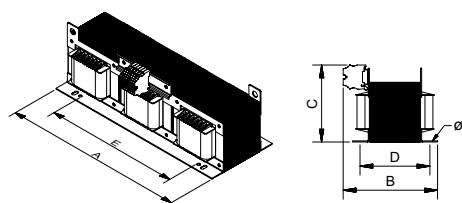

TMTW IP20

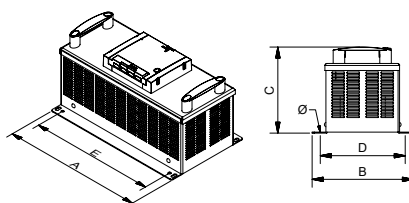

TMTE IP20

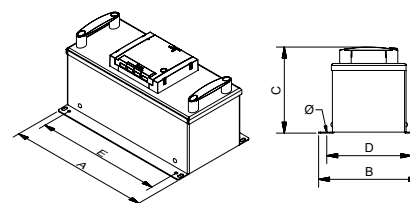

On-request manufacturing options (please see prices)

Power	From 15 VA to 400 VA
Frequency	From 50 Hz to 400 Hz
Operation	Intermittent, continuous
Electrostatic shield	Up to three shields
Class	I, II
Altitude	Up to 4000 m



TMT SERIES

For adapting the voltage in measuring equipment

Feature plate structure

Label for TMTX:

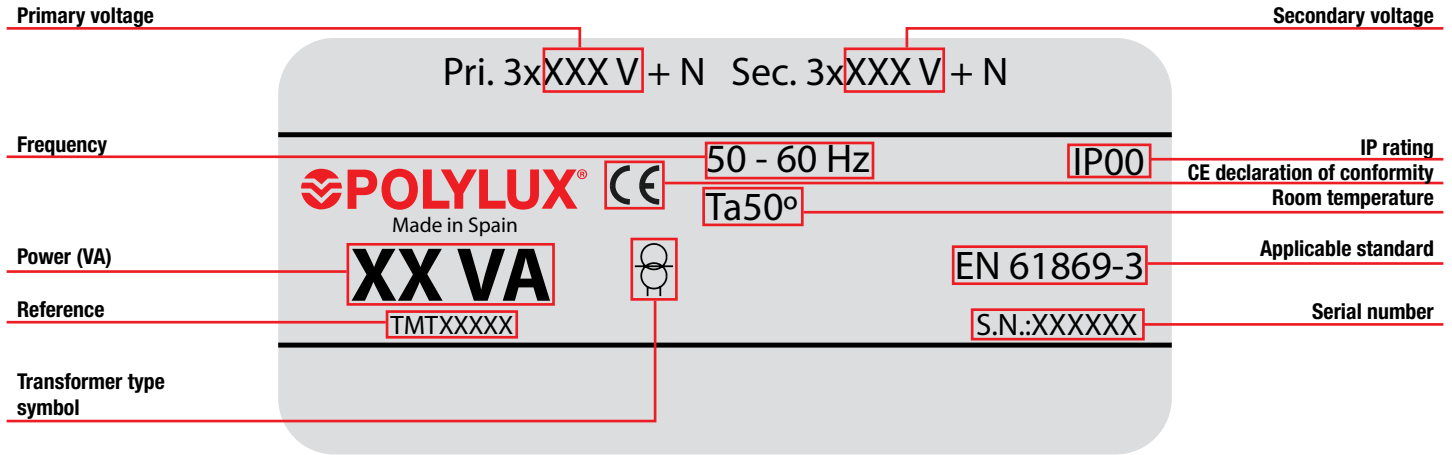

Label for TMTW and TMTE:

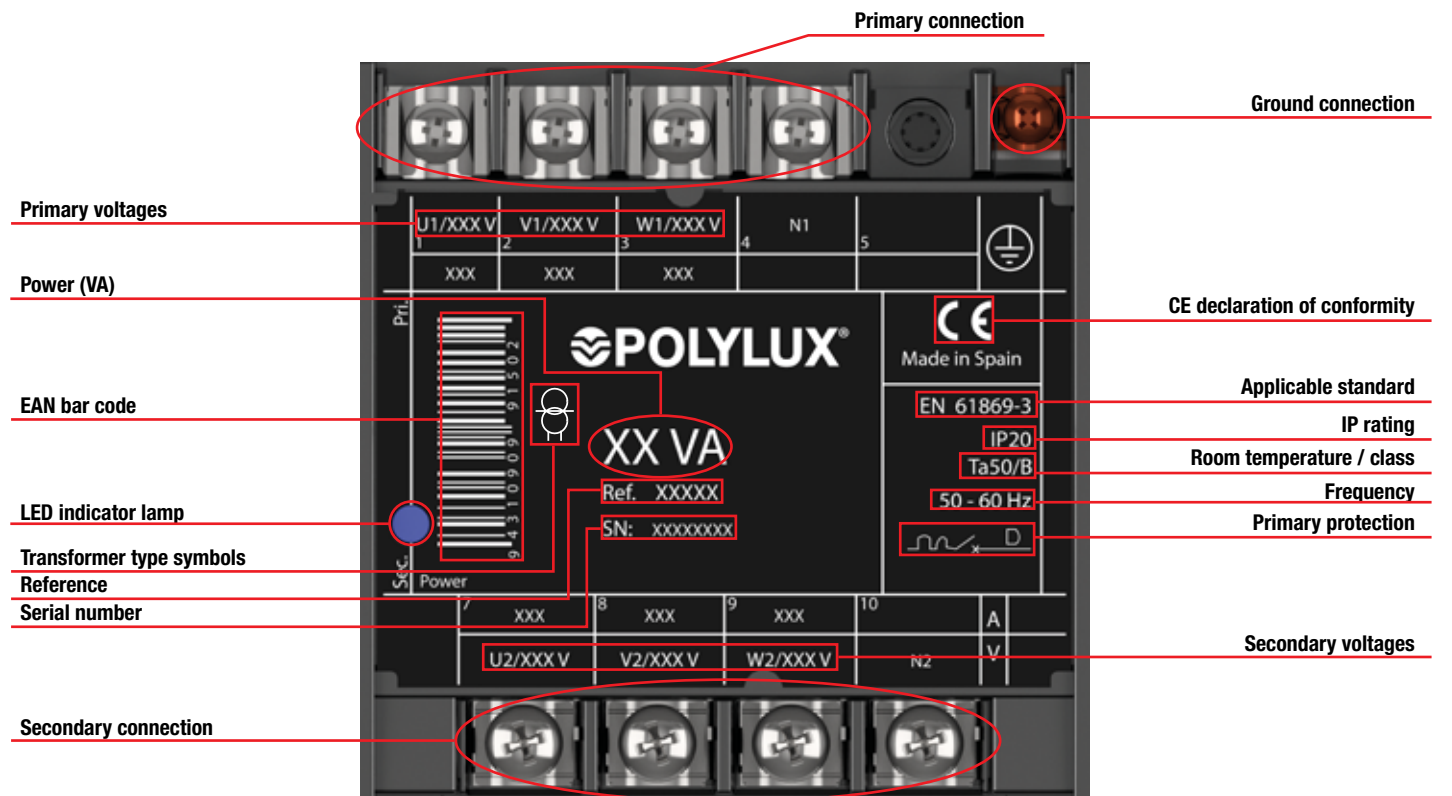

TIB SERIES

Primary winding · Secondary current **5 A**



Definition and applications

The TIB transformer series are current transformers designed for use as energy monitoring products.

They may be used as measuring transformers or protection transformers:

- Measuring transformer:**
 Short circuiting in terminals or connection to ground may be done using the fast-on or connecting two cables to the same terminal.
- Protection transformer:**
 When a current transformer is used to create a current for protection relays, its characteristics are different from those of measuring transformers. In fact the magnetic circuit of the measuring transformer will be saturated with Class 5P in primary currents, whereas in the protection transformers, the value of the secondary currents must follow the increment in the primary currents, which may reach 10-15-20 In, to guarantee the activation of the relay in the event of an unforeseen power cut. It is important not to load with a power (P) greater than that indicated to ensure that the current transformer saturation value is not modified.
 $P = R * I^2$
 P= Load connected to the current transformer.
 R= Relay resistance + cable resistance
 I = Nominal secondary current of the current transformer

Technical features - standard model

Standard power	3 VA / 6 VA
Standard current	- Input: 10 A to 25 A - Output: 5 A
Standard frequency	50-60 Hz
Thermal short circuit current	40 IpN 1 sec.
Dynamic short circuit current	2.5 I th 1 sec.
Permanent nominal thermal current	120% Icth
Class	I / III
Insulators	In air, class E
IP rating	IP30
Room temperature	-20 °C to 40 °C
Mounting	Mounted on DIN 46277/3 rail or with screws
Standards	EN 61869-2
Test voltage	3 kV (1 min., 50 Hz)
Operation	Continuous
Cooling	AN

Manufacturing characteristics

- Sealable terminal cover included.
- Fastening system with screws or **DIN rail**.
- All the transformers are checked automatically one by one and the compliance test report is created in accordance with the corresponding standard.

Connection

- Primary P1(K) P2(L)
- Secondary s1(k) s2(l)

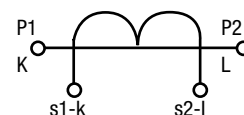

Measurements

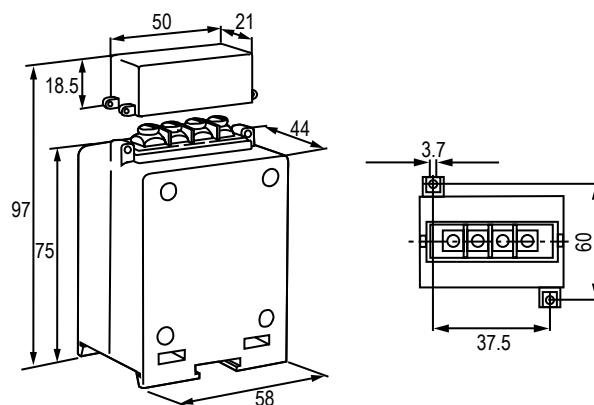

Theoretical data - standard model

I prim. / I sec. A	Reference	Weight kg
10 / 5	TIB10A	0.4
15 / 5	TIB15A	0.4
25 / 5	TIB25A	0.4



TIP SERIES

Primary pass-through · Secondary current **5 A**



Definition and applications

The TIP series transformers are current transformers designed for use as energy monitoring products.

They may be used as measuring transformers or protection transformers:

- Measuring transformer:**
Short circuiting in terminals or connection to ground may be done using the fast-on or connecting two cables to the same terminal.
- Protection transformer:**
When a current transformer is used to create a current for protection relays, its characteristics are different from those of measuring transformers. In fact the magnetic circuit of the measuring transformer will be saturated with Class 5P in primary currents, whereas in the protection transformers, the value of the secondary currents must follow the increment in the primary currents, which may reach 10-15-20 In, to guarantee the activation of the relay in the event of an unforeseen power cut.
It is important not to load with a power (P) greater than that indicated to ensure that the current transformer saturation value is not modified.
 $P = R \cdot I^2$
P= Load connected to the current transformer.
R= Relay resistance + cable resistance
I = Nominal secondary current of the current transformer

Technical features - standard model

Standard power	1 VA to 12 VA
Standard current	- Input: 40 A to 500 A - Output: 5 A
Standard frequency	50-60 Hz
Thermal short circuit current	40 IpN 1 sec.
Dynamic short circuit current	2.5 I th 1 sec.
Permanent nominal thermal current	120% Icth
Class	I / III
Insulators	In air, class E
IP rating	IP30
Room temperature	-20 °C to 40 °C
Mounting	Mounted on DIN 46277/3 rail or with screws
Standards	EN 61869-2
Test voltage	3 kV (1 min., 50 Hz)
Operation	Continuous
Cooling	AN

Manufacturing characteristics

- Sealable terminal cover included.
- Fastening system with screws or **DIN rail**.
- All the transformers are checked automatically one by one and the compliance test report is created in accordance with the corresponding standard.

Connection

- Primary P1(K) P2(L)
- Secondary s1(k) s2(l)

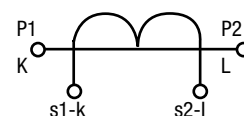

Theoretical data - standard model

I prim. / I sec. A	Reference	Plate diam.
40 / 5	TIP40A	21mm - 30x10
50 / 5	TIP50A	21mm - 30x10
100 / 5	TIP100A	21mm - 30x10
150 / 5	TIP150A	21mm - 30x10
200 / 5	TIP200A	32mm - 40x10
250 / 5	TIP250A	32mm - 40x10
300 / 5	TIP300A	32mm - 40x10
400 / 5	TIP400A	50mm - 60x10
500 / 5	TIP500A	50mm - 60x10

Measurements

Reference	External dimensions mm					Weight kg
	A	B	C	D	E	
TIP40A	58	70	97	37.5	60	0.3
TIP50A	58	70	97	37.5	60	0.3
TIP100A	58	70	97	37.5	60	0.3
TIP150A	58	70	97	37.5	60	0.3
TIP200A	75	70	109	45.5	60	0.5
TIP250A	75	70	109	45.5	60	0.7
TIP300A	75	70	109	45.5	60	0.7
TIP400A	105	85	131	82	76.7	1
TIP500A	105	85	131	82	76.7	1

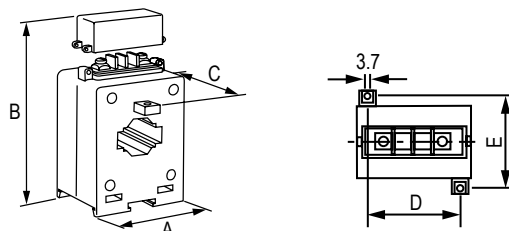

TIN SERIES

Open core (SPLIT) · Secondary current **5 A**



Definition and applications

The TIN series are current transformers designed for use as energy monitoring products.

They may be used as measuring transformers or protection transformers:

- Measuring transformer:**
 Short circuiting in terminals or connection to ground may be done using the fast-on or connecting two cables to the same terminal.
- Protection transformer:**
 When a current transformer is used to create a current for protection relays, its characteristics are different from those of measuring transformers. In fact the magnetic circuit of the measuring transformer will be saturated with Class 5P in primary currents, whereas in the protection transformers, the value of the secondary currents must follow the increment in the primary currents, which may reach 10-15-20 In, to guarantee the activation of the relay in the event of an unforeseen power cut. It is important not to load with a power (P) greater than that indicated to ensure that the current transformer saturation value is not modified.

$$P = R \cdot I^2$$
 P= Load connected to the current transformer.
 R= Relay resistance + cable resistance
 I = Nominal secondary current of the current transformer

Technical features - standard model

Standard power	1.5 VA to 30 VA
Standard current	- Input: 400 A to 1500 A - Output: 5 A
Standard frequency	50-60 Hz
Thermal short circuit current	40 IpN 1 sec.
Dynamic short circuit current	2.5 I th 1 sec.
Permanent nominal thermal current	120% Icth
Class	I / III
Insulators	In air, class E
IP rating	IP30
Room temperature	-20 °C to 40 °C
Mounting	Fastened with screws
Standards	EN 61869-2
Test voltage	3 kV (1 min., 50 Hz)
Operation	Continuous
Cooling	AN

Manufacturing characteristics

- Sealable terminal cover included.
- Fastening system with screws or **DIN rail**.
- All the transformers are checked automatically one by one and the compliance test report is created in accordance with the corresponding standard.

Connection

- Primary P1(K) P2(L)
- Secondary s1(k) s2(l)

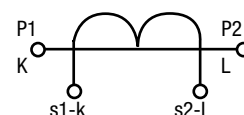

Measurements

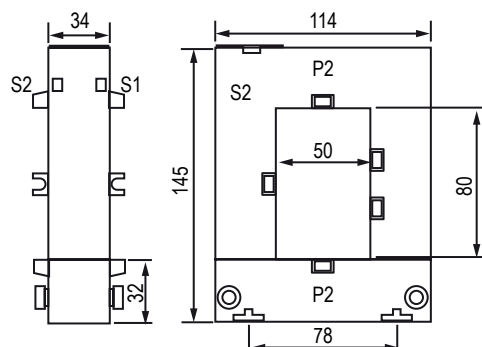

Theoretical data - standard model

I prim. / I sec. A	Reference	Plate	Weight kg
400 / 5	TIN400A	80x50	1.3
500 / 5	TIN500A	80x50	1.3
600 / 5	TIN600A	80x50	1.3
800 / 5	TIN800A	80x50	1.3
1000 / 5	TIN1000A	120x80	1.8
1200 / 5	TIN1200A	120x80	1.8
1500 / 5	TIN1500A	120x80	1.8



CTM4 SERIES

Temperature control unit



Definition and applications

An excessive increase in the temperature of a power transformer is a sign of overload or malfunctions; the detection of critical values enables a preventive diagnosis of the system, anticipating faults and costly damages.

The CTM4 temperature measuring unit makes it possible to measure and control four temperature values usually related to the winding and for the international temperature of the panel, measured with PT100 sensors from -30 to +220 ° C.

Two alarm levels can be set for each measuring channel (alarm tripper) to activate the switching of the output relays, which can be used for remote signalling or for the controlled disabling of the equipment. There are five programming keys on the front part of the instrument and two 3-digit displays that show temperatures and the alarm status of the measuring channels. The presence of a RS485 serial port or an ethernet port permits the control and programming of the station and connection via a Modbus-RTU or Modbus-TCP protocol to acquisition systems (PC, PLC, SCADA, etc.)

Technical features - standard model

Auxiliary power supply	
Operating voltage	115-230-400 VAC // 24÷230 VAC/DC (optional)
Nominal frequency	50-60 Hz
Self-consumption	4 VA max.
Inputs	
Sensors	4 PT100 RTD (not included)
Type	3 wires (2 and 4 versions are also admitted)
Measuring range	-30 ... + 220 °C
Compensation	20 Ω max.
Intervention delay / hysteresis	5 s / 2 °C
Relay outputs	
Number	4
Type	NA-C-NC
V max.	12 VDC
I max.	8 A (resistive load)
Functions	Alarm, intervention, ventilation and self-diagnosis
RS485 serial interface (option)	
Serial node address	01-247
Programmable baud rate	2400 - 19200 bps
Data format	8 bit, no parity - 8 bit, odd - 8 bit, even
Stop bits	1-2
Protocol	Modbus RTU
Monitor	
Technology	7-segment LED
Connections	
Terminals	Detachable screws
Maximum cross-section	2.5 mm ²
Insulation	
Voltage	2.5 kV for 1 minute
Environmental operating conditions	
Operating temperature	-10 ... +55 °C
Storage temperature	-25 ... +80 °C
Relative humidity	90% max.
Enclosure	
Dimensions	96x96 mm
Weight	0.5 kg
Protection rating	IP52 front // IP20 rear
Conformity	
Standards	CEI EN 61000-6-2: 2006 CEI EN 61000-6-4: 2007 CEI EN 61010-1: 2013

Manufacturing characteristics

- Viewing of instant and maximum temperature.
- Double intervention level: alarm (ALARM) and release (TRIP).
- Self-diagnosis function for anomalies or incorrect installation (FAULT).
- Programmable outputs for all types of anomalies or failure conditions.
- Option of forced ventilation activation (FAN).
- FDC function for automatic control of temperature difference in a defined time.
- RS485 serial port modbus RTU for integration with supervision or remote control networks.

Accessories applicable on request

- IP65 front cover (CAL96x96)



MP96X96IP65



Electrical diagram

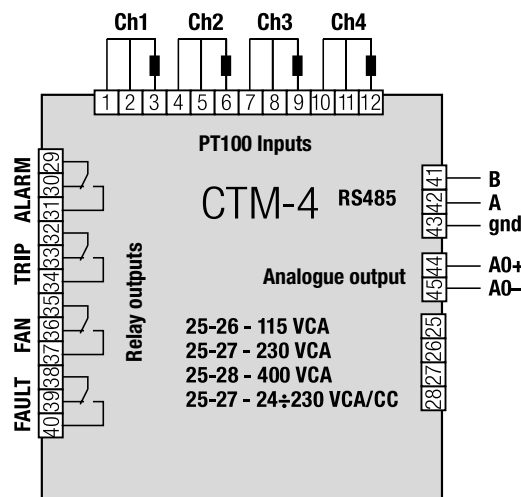



STM4 SERIES

Temperature control unit

Panel structure

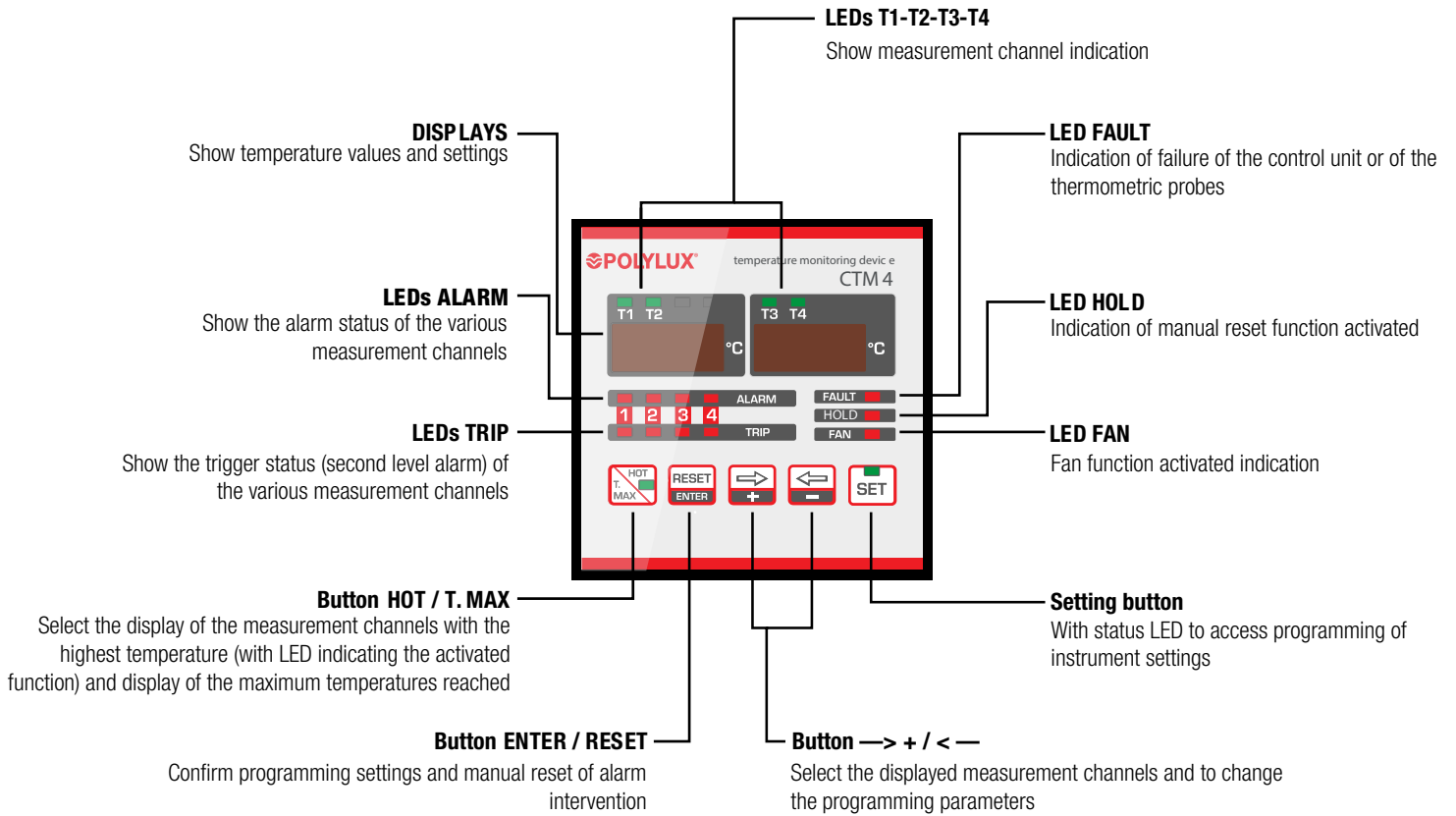

Measurements

In mm

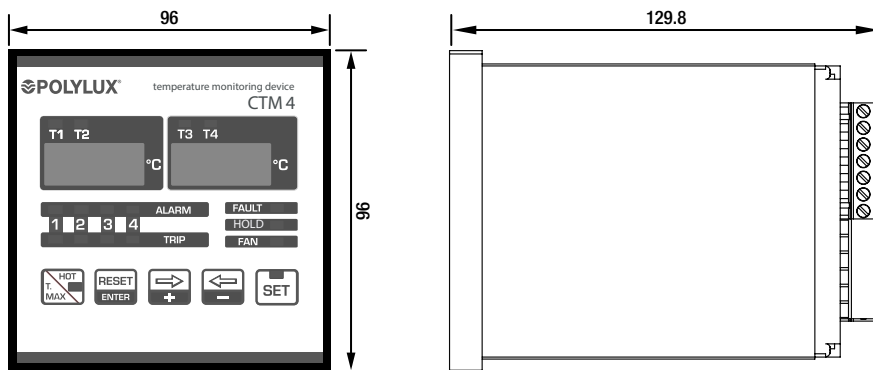



MR12 SERIES

Remote monitor for up to 12 viewers VA40-485



Definition and applications

The MR12 remote monitoring system device provides a data gathering function and a supervisory interface. The remote control is for the VA40 with an RS485 Modbus-RTU communication bus. It can monitor up to 12 VA40-485 units.

Manufacturing characteristics

- LCD graphic display, 128x64 pixels
- Panel-mounted, standard 96x96 mm container
- 4 keys at front for viewing and settings
- Integrated buzzer
- Built-in double RS485 communication interface
- Fast, simple navigation
- Front programming

Technical features - standard model

Auxiliary power supply	
Operating voltage	90-250 VAC // 20-60 VCA/DC (optional)
Nominal frequency	45-65 Hz
Self-consumption	4 VA
RS485 COM1 serial interface	
Programmable baud rate	9600-38400 bps
RS485 COM2 serial interface (optional)	
Programmable baud rate	9600-38400 bps
Protocol admitted	Modbus RTU
ETHERNET interface (optional)	
Network interface	RJ45 Ethernet 10BASE-T or 100BASE-TX (automatic detection)
Protocol admitted	Modbus TCP
Insulation	
Insulation voltage	1kV for 1 minute
Enclosure	
Mounting	Flush mounted
Dimensions	96x96x81 mm
Front panel cutout	92x92 mm
Protection rating	IP52 front // IP20 rear
Weight	< 500 g
Environmental operating conditions	
Operating temperature	-10 ... +60 °C
Storage temperature	-25 ... +70 °C
Relative humidity	5...90%
Conformity	
Standards	EN 50081-1 EN 50082-2 EN 61010-1

Terminal position

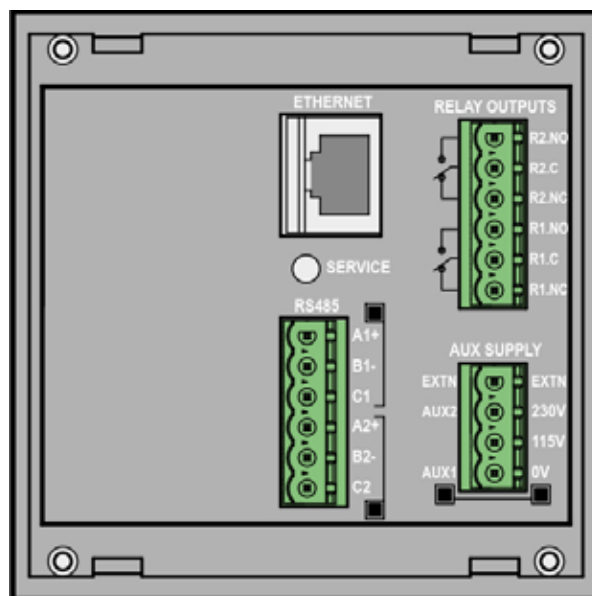

Measurements

In mm

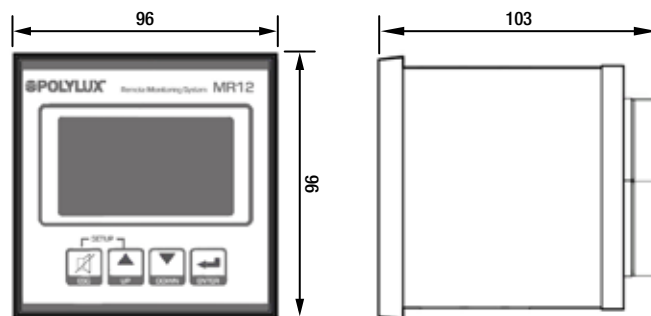



VA40 SERIES

Insulation monitor and RS485 communication bus



Definition and applications

The insulation monitor applies a direct current measuring signal between the insulated line and ground, in order to detect whether a leakage current has been generated. To ensure the measuring efficiency, even in the presence of perturbations and harmonic components, the monitor has a built-in digital filter and also uses an encoded signal. The VA40 also permits the control of the electrical and thermal overload of the medical isolation transformer, controlling two different temperature thresholds in the PT100 and PTC sensors. The temperature control enables the monitoring of the transformer overload and bypasses the circuit breaker downstream of the secondary. To detect **AC and DC leakages** we have the **VA40F-485**.

Technical features - standard model

Supply voltage	110 - 230 V
Frequency	50-60 Hz
Network voltage to be checked	24 ÷ 230 VCA
Maximum voltage measurement	24 V
Maximum current measurement	1 mA
Insulation voltage	2.5 kV / 60 seconds
Type of control signal	Continuous component with digital filter
Measurements detected	Insulation measuring range 0 ÷ 999 kΩ HIGH - resolution of 1 kΩ
	Measuring of temperature with Rd PT100 thermal sensor with 2 or 3 wires - 0 ÷ 250 °C, precision 2%
Intervention thresholds	Impedance measurement 0 ÷ 999 kΩ / HIGH - resolution 1 kΩ (test signal 2500 Hz)
	Low insulation 50 ÷ 500 kΩ, precision 5%, hysteresis, configurable delay
	Overtemperature 0 ÷ 200 °C, precision 2%
	Current overload 1 ÷ 999 A, precision 2%
	Low impedance (can be disabled)
Available outputs	Device not connected to line (Link-Fail)
	Up to a maximum of 4 CR5 panels for remote signalling
Connections	Programmable auxiliary NA-C-NC relay output, 5A, 250 VCA
	RS485 serial output, standard Modbus RTU protocol
Operating temperature	Maximum connectible cross-section 2.5 mm²
Storage temperature	-10...60 °C
Dimensions	-25...70 °C, humidity <90%
Weight	6 DIN modules
Enclosure	0.5 kg
	Self-extinguishing polymer for mounting on 35 mm DIN rail with transparent protective front cover
Protection rating	IP20
Self-consumption	5 VA
Standards	IEC EN 60364-7-710, IEC EN 61557-8, EN 60255-6, UNE 20615

Manufacturing characteristics

All failure conditions are controlled remotely thanks to a connection with the CR5 remote signalling panels to guarantee the opportune adequate technical supervision. In addition, it is fitted with an RS485 serial port through which it can be perfectly integrated with PLC / PC communication systems using the Modbus RTU protocol. Lastly, it is worth noting that the VA40 has a self-diagnosis system called ERROR-LINK FAIL, which checks the presence and correction of cabling at the ends of the terminals, thus ruling out the possibility of having unit 2 in operation in the medical room without the supervision of the insulation monitor.

Measurements

In mm

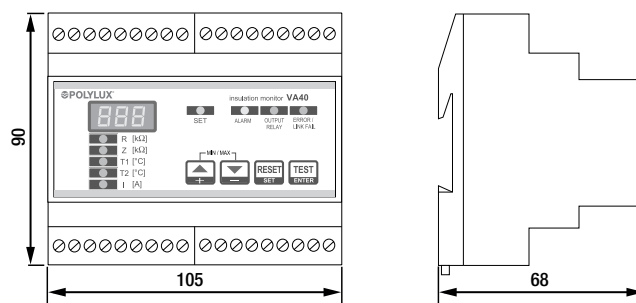



VA40 SERIES

Insulation monitor and RS485 communication bus

Electrical diagram

- Single-phase

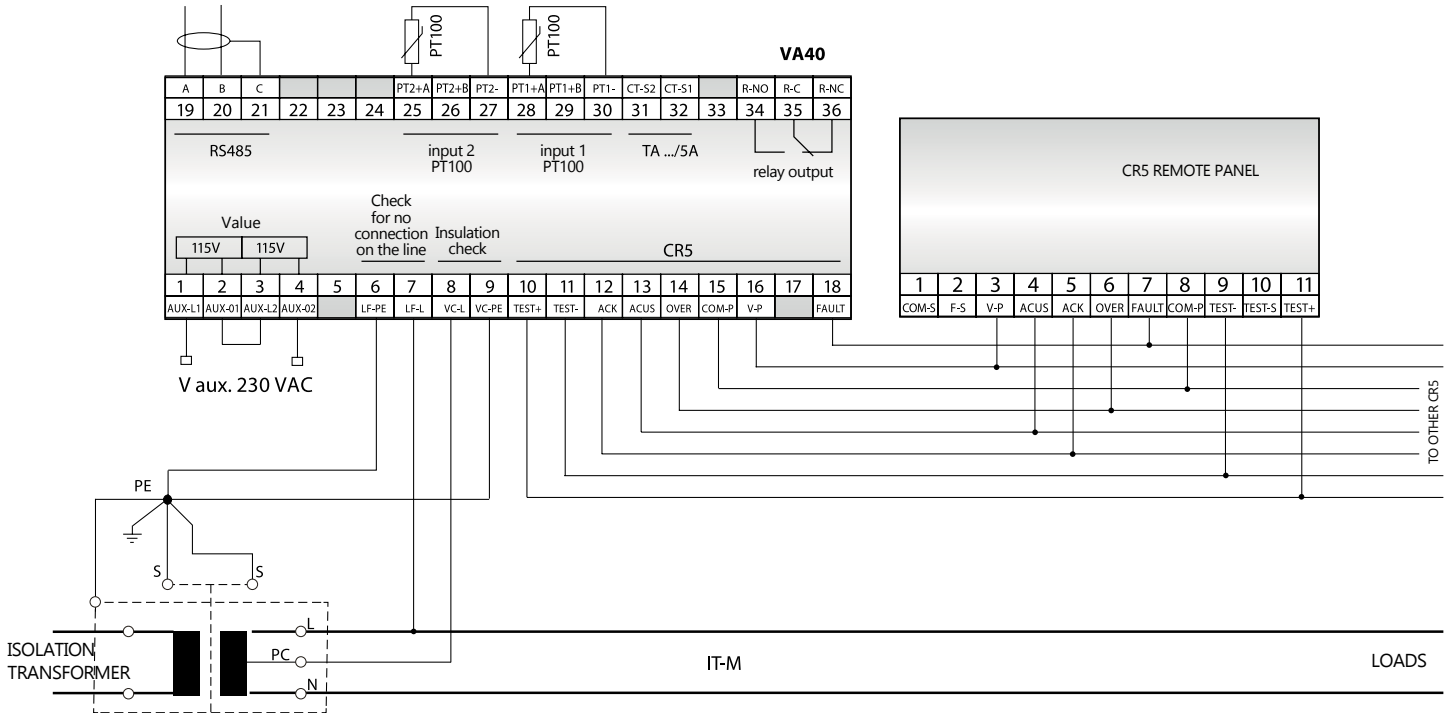

- Three-phase

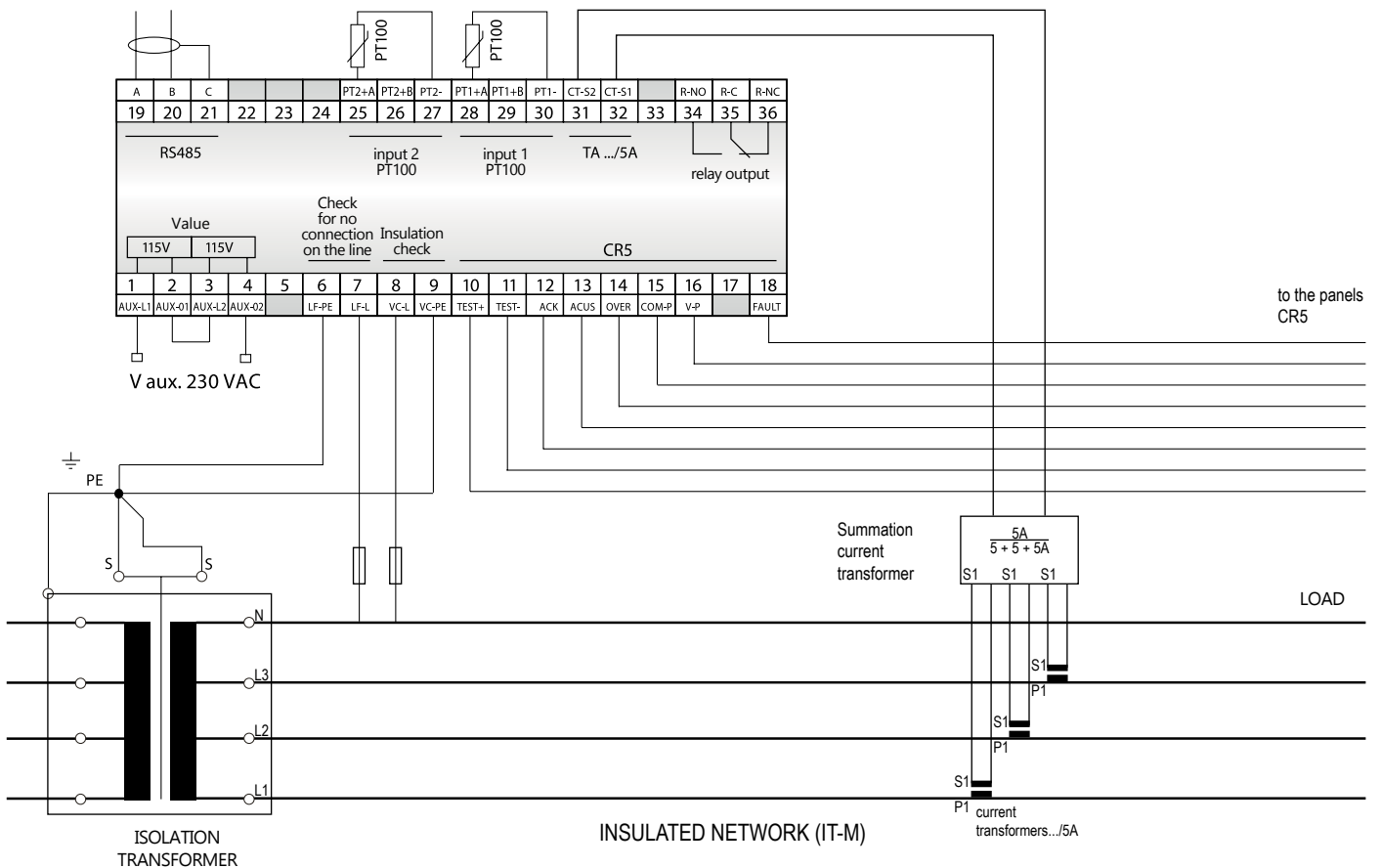



VA40 SERIES

Insulation monitor and RS485 communication bus

Panel structure

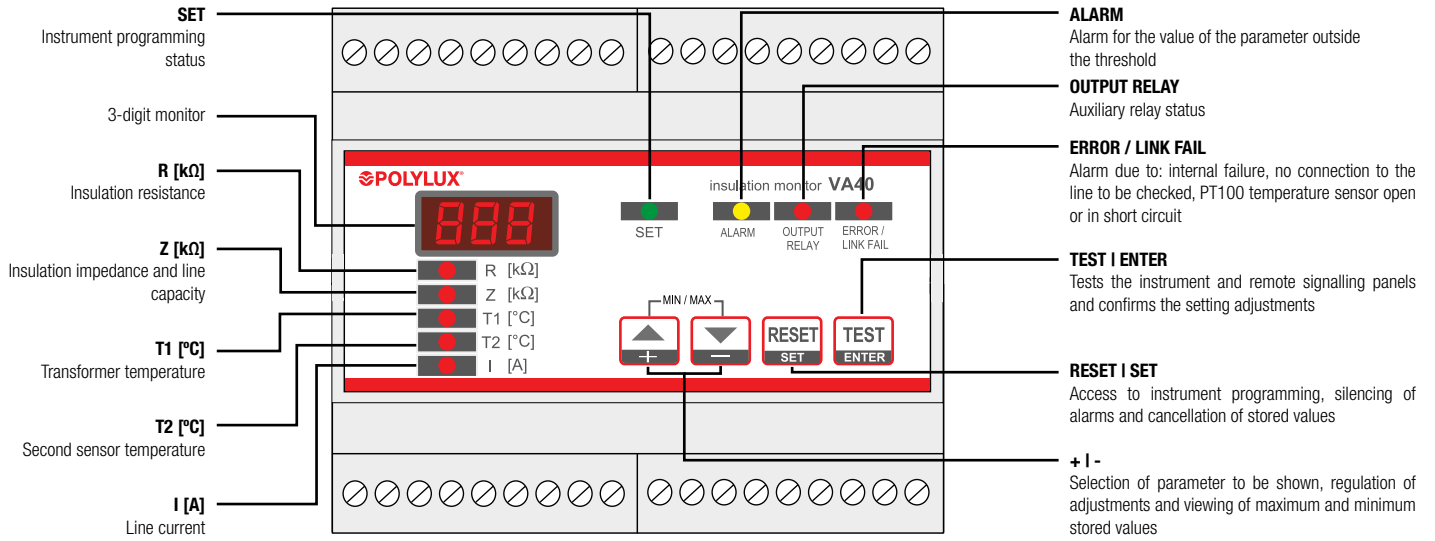



CR5 SERIES

Panel indicator light



Definition and applications

The CR5 remote signalling panel permits the reporting of the insulation monitor alarm signals in all the manned rooms, as required by the reference standards. The CR5 panel produces an acoustic and a luminous signal in the case of an alarm due to low insulation or in the event of a thermal and electrical overload. It also has a TEST button to perform regular checks on the operating status and a button to silence the acoustic signal.

Manufacturing characteristics

- Small size.
- Easy to install and mount in a universal E503 box.
- Reliability, immediate recognition of failure types.
- Comfort, simultaneous silencing of various signalling panels.
- Operating efficiency: acoustic and luminous signalling.

Technical features - standard model

Acoustic signal.	2400 Hz emission 2 Hz dB intermittence
Terminal cross-section	2 mm²
Protection rating	IP30
Weight	200 g
Operating temperature	-10 ÷ 60 °C, maximum humidity 95%
Storage temperature	-20 ÷ 80 °
Insulation	2500 v rms 50 Hz for 60 s
Minimum cable cross-section	0.35 mm² (300 m max.)
Standards	IEC-EN 61010-1, IEC EN 61557-8, IEC EN 60364-7-710, UNE 20615, IEC EN 61326-1

Measurements

In mm

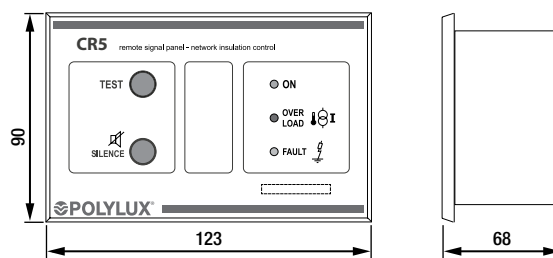

Panel structure

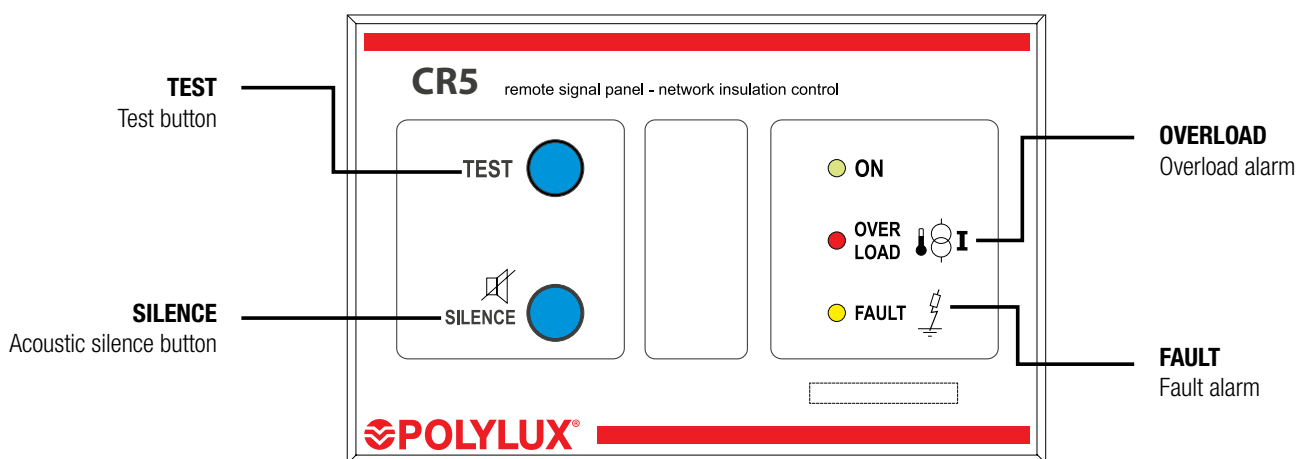



T11 SERIES

Current transformer



Definition and applications

The function of this equipment is the constant reading of the transformer's secondary current, which matches the isolated network so that the monitor can activate the alarm in the event of an overload.

The monitor must first have been configured with the admissible current of this network, depending on its loads.

Measurements

In mm

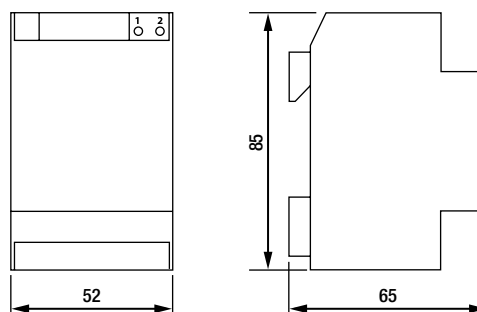

Technical features - standard model

Reference voltage for isolation.	0.72 kV
Operating frequency	50-60 Hz
Dielectric strength test voltage	3 kV (1 min., 50 Hz)
Insulation	Class B
Protection rating	IP20
Permanent surge current	1.2 In
Occasional thermal current	40 In
Working temperature	-25 to 50 °C
Storage temperature	-40 to 80 °C
Standards	IEC / EN 60044-1





TR SERIES

Encapsulated rectifiers with no filter · Input 230 V · Output 12 V (TRA), 24 V (TRB) and 48 V (TRC) · Not stabilised



Definition and applications

The TR rectifier transformers are used in applications in which the loads must be supplied continuously and can operate with a voltage ripple of 48%.

Manufacturing characteristics

- All the versions have the following features in common:
- Connection terminals made of copper, welded and inserted in blocks to prevent hazards caused by expansion that may lead to poor connection.
 - Option of mounting on **DIN rail up to TRA4 and TRB2.5**.
 - Encapsulated in resin
 - All the live parts of these transformers are encapsulated in resin, which is particularly indicated for working in damp, saline and corrosive environments.
 - They have greater resistance to current surges and transient harmonics.
 - Greater mechanical resistance to vibrations and undesirable movements.
 - All the transformers are checked automatically one by one and the compliance test report is created in accordance with the corresponding standard.

Technical features - standard model

Output current	1.6 A to 63 A
Insulators	Class B - 130 °C
Winding	Class HC - 200 °C
Room temperature	45 °C
Frequency	50-60 Hz
Noise	≤ 45 dB
Protection rating	IP20
Cooling	AN
Mounting	With screws (for all powers) Mounting on DIN 46277/3 rail (up to TRA4 and TRB2.5)
Standards	IEC/EN/UNE-EN 61204, CE
Maximum ripple	48 %
Operation	Continuous
Test voltage	3 kV (1 min., 50 Hz) between primary and secondary 3 kV (1 min., 50 Hz) between primary and ground 0.5 kV (1 min., 50 Hz) between secondary and ground

Electrical diagram

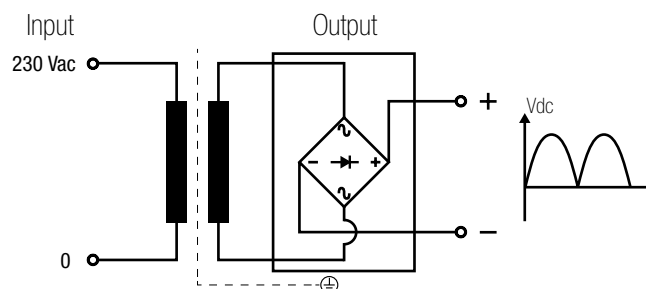



TR SERIES

Encapsulated rectifiers with no filter · Input 230 V · Output 12 V (TRA), 24 V (TRB) and 48 V (TRC) · Not stabilised

Terminal types

Terminal blocks	Dimensions mm				Maximum tightening torque N·m	Primary		Secondary	
	A	B	C	Ø		Output current A		Output current A	
						From	To	From	To
TRA									
Terminal M4	10	13.5	12	M4	1.1	1.6	25	1.6	25
Terminal M5	15	18.5	14	M5	2.5	40	63	40	63
TRB									
Terminal M4	10	13.5	12	M4	1.1	1.6	10	1.6	10
Terminal M5	15	18.5	14	M5	2.5	16	63	16	63
TRC									
Terminal M4	10	13.5	12	M4	1.1	1.6	6.3	1.6	6.3
Terminal M5	15	18.5	14	M5	2.5	10	40	10	40
Terminal M6	15.5	20.4	13	M6	4	63	63	63	63

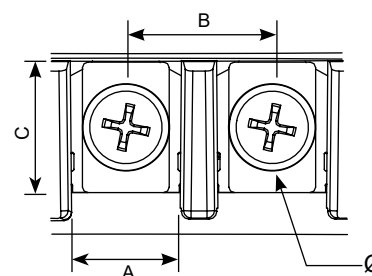

Theoretical data - standard model

Output current Adc	Reference	Input current (A)	Maximum cross-section input conductor (mm ²)		Maximum cross-section output conductor (mm ²)		Input protections (A) (MCB -> D / Fuse -> aM)	Output protections (A) (MCB -> C / Fuse -> gG)
		230 V	Flexible	Rigid	Flexible	Rigid		
TRA (output voltage 12 V)								
1.6	TRA1.6	0.11	0.5	0.5	1	1.5	0.3 (--/T)	1.6
2.5	TRA2.5	0.17	0.5	0.5	1	1.5	0.4 (--/T)	2.5
4	TRA4	0.27	0.5	0.5	1	1.5	0.6	4
6.3	TRA6.3	0.43	0.5	1	1.5	2	1	6.3
10	TRA10	0.68	0.5	1	2	2.5	2	10
16	TRA16	1.1	0.5	1	4	-	3	16
25	TRA25	1.7	1	1.5	4	-	4	25
40	TRA40	2.7	1	1.5	8	-	10	40
63	TRA63	4.3	1.5	2	16	-	10	63
TRB (output voltage 24 V)								
1.6	TRB1.6	0.22	0.5	0.5	1	1.5	0.5	1.6
2.5	TRB2.5	0.34	0.5	0.5	1	1.5	1	2.5
4	TRB4	0.54	0.5	1	1	1.5	2	4
6.3	TRB6.3	0.85	0.5	1	1.5	2	2	6.3
10	TRB10	1.4	0.5	1	2	2.5	3	10
16	TRB16	2.2	1	1.5	4	-	6	16
25	TRB25	3.4	1	1.5	4	-	10	25
40	TRB40	5.4	1.5	2	8	-	16	40
63	TRB63	8.5	2	2.5	16	-	20	63
TRC (output voltage 48 V)								
1.6	TRC1.6	0.43	0.5	1	1	1.5	1	1.6
2.5	TRC2.5	0.68	0.5	1	1	1.5	2	2.5
4	TRC4	1.1	0.5	1	1	1.5	3	4
6.3	TRC6.3	1.7	1	1.5	1.5	2	4	6.3
10	TRC10	2.7	1	1.5	2	2.5	10	10
16	TRC16	4.3	1.5	2	4	-	10	16
25	TRC25	6.8	1.5	2	4	-	16	25
40	TRC40	10.9	2.5	4	8	-	25	40
63	TRC63	17.1	4	-	16	-	40	63





TR SERIES

Encapsulated rectifiers with no filter · Input 230 V · Output 12 V (TRA), 24 V (TRB) and 48 V (TRC) · Not stabilised

Measurements

Output current A	Output voltage 12 V (DC) not stabilised TRA								Output voltage 24 V (DC) not stabilised TRB								Output voltage 48 V (DC) not stabilised TRC							
	Ref.	External dimensions mm			Fastening elements mm			Weight kg	Ref.	External dimensions mm			Fastening elements mm			Weight kg	Ref.	External dimensions mm			Fastening elements mm			Weight kg
		A	B	C	D	E	Ø			A	B	C	D	E	Ø			A	B	C	D	E	Ø	
1.6	TRA1.6	80	97	74	80	56	6	0.76	TRB1.6	95	96	85	80	56	6	1.3	TRC1.6	95	96	100	80	56	6	1.8
2.5	TRA2.5	80	97	84	80	56	6	0.95	TRB2.5	95	96	100	80	56	6	1.8	TRC2.5	104	102	110	86	65	6	2.7
4	TRA4	111	100	99	80	56	6	1.4	TRB4	120	102	124	86	65	6	2.8	TRC4	132	112	130	96	76	6	3.8
6.3	TRA6.3	112	100	122	80	56	6	1.9	TRB6.3	133	112	128	86	65	6	3.3	TRC6.3	145	122	157	106	89	6	5.5
10	TRA10	125	102	142	86	65	6	2.9	TRB10	149	122	157	106	89	6	4.9	TRC10	167	145	199	125	102	7	9.3
16	TRA16	137	112	160	96	76	6	4	TRB16	167	145	191	125	102	7	7.4	TRC16	191	165	224	145	125	7	13.6
25	TRA25	149	122	195	106	89	6	6.3	TRB25	167	145	237	125	102	7	11.3	TRC25	191	165	270	145	125	7	17.8
40	TRA40	167	145	227	125	102	7	10	TRB40	191	165	250	145	125	7	15.8	TRC40	240	290	200	178	173	7	31.4
63	TRA63	240	290	200	145	125	7	15	TRB63	240	290	200	178	173	7	27	TRC63	290	340	240	212	220	7	49.4

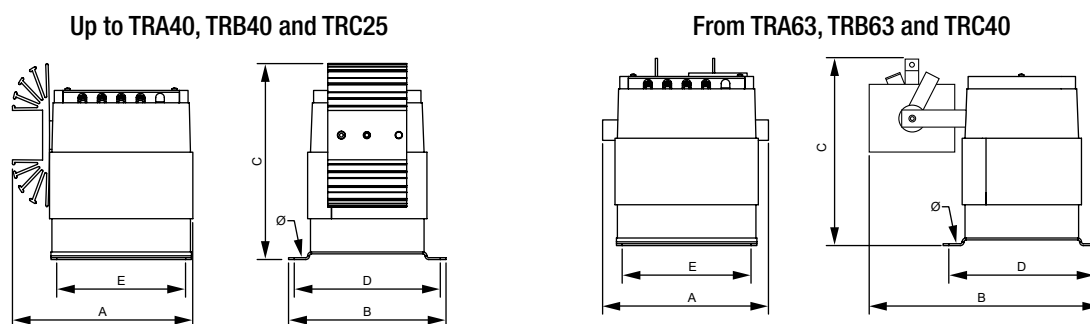

On-request manufacturing options (please see prices)

Output current	From 1.6 A to 63 A
Protections	Primary fuse
Shields	Primary / secondary, primary / ground and secondary / ground



TR SERIES

Encapsulated rectifiers with no filter · Input 230 V · Output 12 V (TRA), 24 V (TRB) and 48 V (TRC) · Not stabilised

Feature plate structure

Primary connection

Primary voltage

Output current (A)

Protection rating

Output voltage

EAN bar code

Frequency

Serial number

Secondary connection

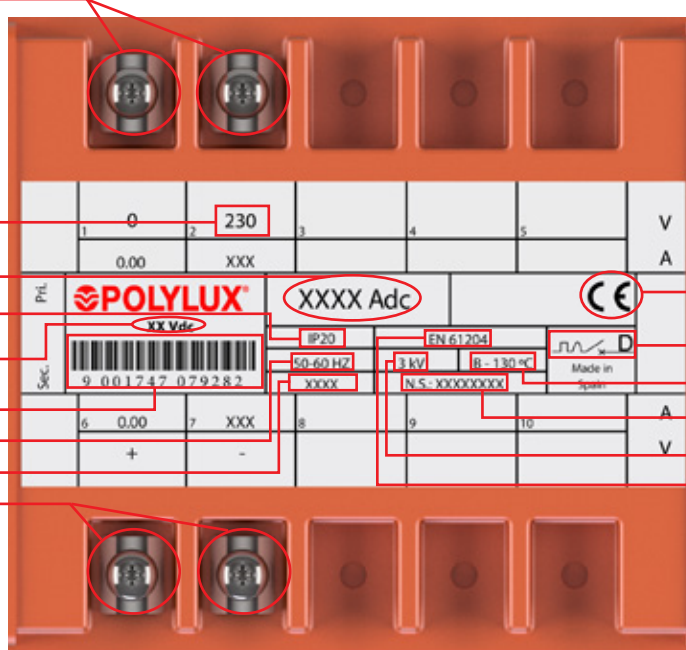

CE declaration of conformity

Primary protection

Insulators

Serial number

Test voltage

Applicable standard





TRF SERIES

Encapsulated rectifiers with filter · Input 230 V · Output 12 V (TRFA), 24 V (TRFB) and 48 V (TRFC) · Not stabilised



Definition and applications

The TRF rectifier transformers are used in applications where the loads require a continuous power supply. With the built-in filter, a ripple of 5% can be obtained, which is suitable for all applications.

Manufacturing characteristics

- All the versions have the following features in common:
- Connection terminals made of copper, welded and inserted in blocks to prevent hazards caused by expansion that may lead to poor connection.
 - Option of mounting on **DIN rail up to TRFA2.5, TRFB2.5 and TRFC1.6.**
 - Encapsulated in resin
 - Protection against electrodynamic stress.
 - All the live parts of these transformers are encapsulated in resin, which is particularly indicated for working in damp, saline and corrosive environments.
 - They have greater resistance to current surges and transient harmonics.
 - Greater mechanical resistance to vibrations and undesirable movements.
 - All the transformers are checked automatically one by one and the compliance test report is created in accordance with the corresponding standard.

Technical features - standard model

Output current	1.6 A to 25 A
Insulators	Class B - 130 °C
Winding	Class HC - 200 °C
Room temperature	45 °C
Frequency	50-60 Hz
Noise	≤ 45 dB
Protection rating	IP20
Cooling	AN
Mounting	With screws (for all powers) Mounting on DIN 46277/3 rail (up to TRFA2.5, TRFB2.5 and TRFC4)
Standards	IEC/EN/UNE-EN 61204, CE
Safety	Class I
Maximum ripple	5 %
Operation	Continuous
Test voltage	3 kV (1 min., 50 Hz) between primary and secondary 3 kV (1 min., 50 Hz) between primary and ground 0.5 kV (1 min., 50 Hz) between secondary and ground

Electrical diagram

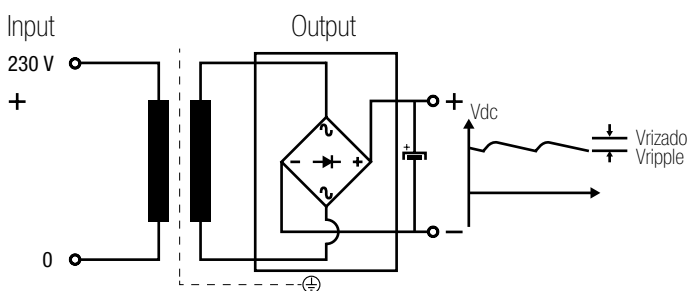



TRF SERIES

Encapsulated rectifiers with filter · Input 230 V · Output 12 V (TRFA), 24 V (TRFB) and 48 V (TRFC) · Not stabilised

Terminal types

Terminal blocks	Dimensions mm				Maximum tightening torque N·m	Primary		Secondary	
	A	B	C	Ø		Output current A		Output current A	
						From	To	From	To
TRFA									
Terminal M4	10	13.5	12	M4	1.1	1.6	16	1.6	16
Terminal M5	15	18.5	14	M5	2.5	16	25	16	25
TRFB									
Terminal M4	10	13.5	12	M4	1.1	1.6	10	1.6	10
Terminal M5	15	18.5	14	M5	2.5	16	25	16	25
TRFC									
Terminal M4	10	13.5	12	M4	1.1	1.6	4	1.6	4
Terminal M5	15	18.5	14	M5	2.5	6.3	25	6.3	25

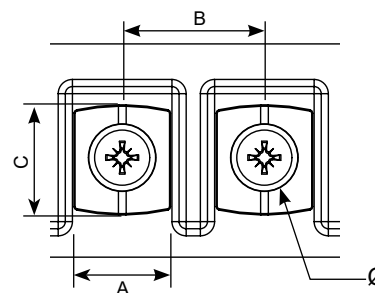

Theoretical data - standard model

Output current Adc	Reference	Input current (A)	Maximum cross-section input conductor (mm ²)		Maximum cross-section output conductor (mm ²)		Input protections (A) (MCB -> D / Fuse -> aM)	Output protections (A) (MCB -> C / Fuse -> gG)
		230 V	Flexible	Rigid	Flexible	Rigid		
TRFA (output voltage 12 V)								
1.6	TRFA1.6	0.13	0.5	0.5	1	1.5	0.3	1.6
2.5	TRFA2.5	0.21	0.5	0.5	1	1.5	0.5	2.5
4	TRFA4	0.33	0.5	0.5	1	1.5	1	4
6.3	TRFA6.3	0.53	0.5	1	1.5	2	2	6.3
10	TRFA10	0.83	0.5	1	2	2.5	2	10
16	TRFA16	1.3	0.5	1	4	-	3	16
25	TRFA25	2.1	1	1.5	4	-	6	25
TRFB (output voltage 24 V)								
1.6	TRFB1.6	0.27	0.5	0.5	1	1.5	0.6	1.6
2.5	TRFB2.5	0.42	0.5	1	1	1.5	1	2.5
4	TRFB4	0.67	0.5	1	1	1.5	2	4
6.3	TRFB6.3	1.1	0.5	1	1.5	2	3	6.3
10	TRFB10	1.7	1	1.5	2	2.5	4	10
16	TRFB16	2.7	1	1.5	4	-	10	16
25	TRFB25	4.2	1.5	2	4	-	10	25
TRFC (output voltage 48 V)								
1.6	TRFC1.6	0.53	0.5	1	1	1.5	2	1.6
2.5	TRFC2.5	0.83	0.5	1	1	1.5	2	2.5
4	TRFC4	1.3	0.5	1	1	1.5	3	4
6.3	TRFC6.3	2.1	1	1.5	1.5	2	6	6.3
10	TRFC10	3.3	1	1.5	2	2.5	10	10
16	TRFC16	5.3	1.5	2	4	-	16	16
25	TRFC25	8.3	2	2.5	4	-	20	25





TRF SERIES

Encapsulated rectifiers with filter · Input 230 V · Output 12 V (TRFA), 24 V (TRFB) and 48 V (TRFC) · Not stabilised

Measurements

Output current A	Output voltage 12 V (DC) not stabilised TRFA								Output voltage 24 V (DC) not stabilised TRFB								Output voltage 48 V (DC) not stabilised TRFC							
	Ref.	External dimensions mm			Fastening elements mm			Weight kg	Ref.	External dimensions mm			Fastening elements mm			Weight kg	Ref.	External dimensions mm			Fastening elements mm			Weight kg
		A	B	C	D	E	Ø			A	B	C	D	E	Ø			A	B	C	D	E	Ø	
1.6	TRFA1.6	133	97	84	80	56	6	1.1	TRFB1.6	148	96	85	80	56	6	1.5	TRFC1.6	157	102	110	86	65	6	2.9
2.5	TRFA2.5	148	96	99	80	56	6	1.5	TRFB2.5	148	96	100	80	56	6	2	TRFC2.5	169	112	106	96	76	6	3.5
4	TRFA4	164	96	122	80	56	6	2	TRFB4	173	102	124	86	65	6	3	TRFC4	197	122	149	106	89	6	5.8
6.3	TRFA6.3	174	102	142	86	65	6	3	TRFB6.3	186	112	138	106	89	6	4.1	TRFC6.3	216	145	169	125	102	7	7.7
10	TRFA10	190	112	150	96	76	6	3.7	TRFB10	202	122	167	106	89	6	6	TRFC10	220	145	209	125	102	7	11.2
16	TRFA16	202	122	185	106	89	6	5.4	TRFB16	220	145	211	125	102	7	9.9	TRFC16	244	165	234	145	125	7	16.1
25	TRFA25	250	250	205	125	102	7	8.6	TRFB25	270	280	225	145	125	7	15	TRFC25	290	310	265	178	173	7	27.7

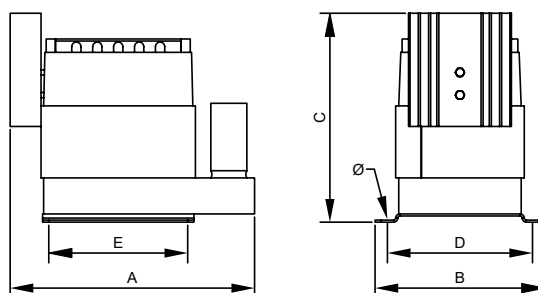

On-request manufacturing options (please see prices)

Output current	From 1.6 A to 25 A
Protections	Fuse from references TRFA1.6, TRFB10 and TRFC4
Shields	Primary / secondary, primary / ground and secondary / ground



TRF SERIES

Encapsulated rectifiers with filter · Input 230 V · Output 12 V (TRFA), 24 V (TRFB) and 48 V (TRFC) · Not stabilised

Feature plate structure

Primary connection

Primary voltage

Output current (A)

Protection rating

Output voltage

EAN bar code

Frequency

Serial number

Secondary connection

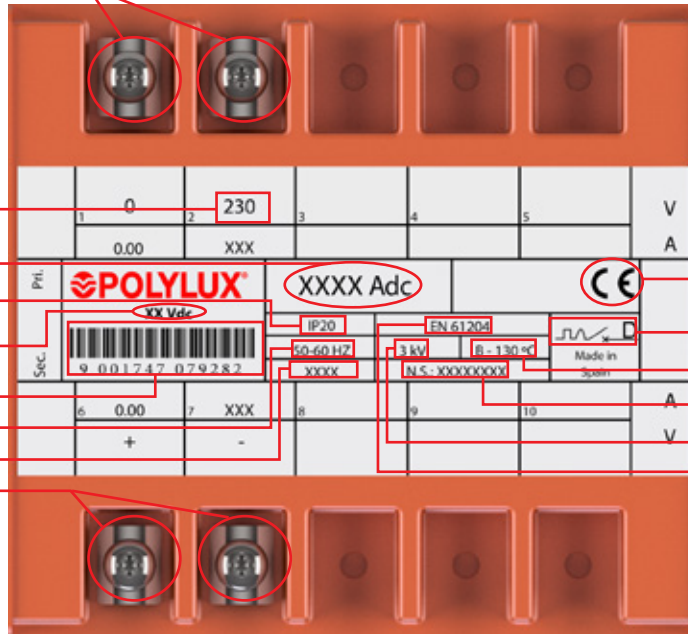

CE declaration of conformity

Primary protection

Insulators

Serial number

Test voltage

Applicable standard



TRT SERIES

Encapsulated rectifiers · Input **400 V** · Output in DC **12 V (TRTA), 24 V (TRTB) and 48 V (TRTC)** · Not stabilised



Definition and applications

The TRT series transformers are encapsulated three-phase transformers for use in applications in which the loads require a continuous power supply when there is a three-phase power supply network.

Manufacturing characteristics

- Terminal protection cover.
- Mounted with screws.
- Electrical feature and connection label.
- Protection against damp, saline and corrosive environments.
- Greater mechanical resistance to vibrations, surge currents and electrodynamic stress.
- LED indicator lamp and overtemperature protection included.
- All the transformers are checked automatically one by one and the compliance test report is created in accordance with the corresponding standard.

Technical features - standard model

Output current	10 A to 1000 A
Standard frequency	50-60 Hz
Connection unit	Yy0
Windings	Class HC-200 °C
Insulators	Class F - 155 °C <small>*More information in Technical Appendix (T.A.1)</small>
Class	I
Altitude	1000 m
IP rating	IP20
Room temperature	45 °C
Standards	IEC/EN/UNE-EN 61204, CE
Test voltage	3 kV (1 min., 50 Hz)
Inrush	< 12 In
Operation	Continuous
Cooling	AN

Electrical diagram

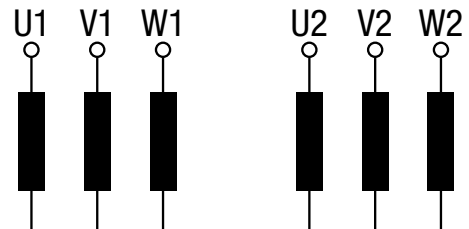



TRT SERIES

Encapsulated rectifiers · Input 400 V · Output in DC 12 V (TRTA), 24 V (TRTB) and 48 V (TRTC) · Not stabilised

Theoretical data - standard model

Output current A (DC)	Reference	Insulation class	Input current (A)	Input protections (A) (MCB -> D / Fuse -> aM)	Output protections (A) (MCB -> C / Fuse -> gG)	Noise dB
			400 V			
TRTA [12 V (DC)]						
10	TRTA10	F	0.26	0.5	10	≤45
16	TRTA16	F	0.42	1	16	≤45
25	TRTA25	F	0.66	2	25	≤45
40	TRTA40	F	1.05	3	40	≤50
63	TRTA63	F	1.65	4	63	≤50
100	TRTA100	F	2.63	10	100	≤50
160	TRTA160	F	4.20	10	160	≤50
250	TRTA250	F	6.57	16	250	≤55
400	TRTA400	F	10.51	25	400	≤60
500	TRTA500	F	13.13	32	500	≤65
630	TRTA630	F	16.55	40	600	≤65
800	TRTA800	F	21.02	50	800	≤65
1000	TRTA1000	F	26.27	63	1000	≤65
TRTB [24 V (DC)]						
10	TRTB10	F	0.44	1	10	≤45
16	TRTB16	F	0.71	2	16	≤45
25	TRTB25	F	1.11	3	25	≤45
40	TRTB40	F	1.78	4	40	≤50
63	TRTB63	F	2.80	10	63	≤50
100	TRTB100	F	4.45	10	100	≤50
160	TRTB160	F	7.11	16	160	≤50
250	TRTB250	F	11.11	25	250	≤55
400	TRTB400	F	17.78	40	400	≤60
500	TRTB500	F	22.23	50	500	≤65
630	TRTB630	F	28.01	63	600	≤65
800	TRTB800	F	35.56	80	800	≤65
1000	TRTB1000	F	44.46	100	1000	≤65
TRTC [48 V (DC)]						
10	TRTC10	F	0.81	2	10	≤45
16	TRTC16	F	1.29	3	16	≤45
25	TRTC25	F	2.02	6	25	≤45
40	TRTC40	F	3.23	10	40	≤50
63	TRTC63	F	5.09	16	63	≤50
100	TRTC100	F	8.08	20	100	≤50
160	TRTC160	F	12.93	32	160	≤50
250	TRTC250	F	20.21	50	250	≤55
400	TRTC400	F	32.33	80	400	≤60
500	TRTC500	F	40.41	100	500	≤65
630	TRTC630	F	50.92	125	600	≤65
800	TRTC800	F	64.66	160	800	≤65
1000	TRTC1000	F	80.83	200	1000	≤65





TRT SERIES

Encapsulated rectifiers · Input 400 V · Output in DC 12 V (TRTA), 24 V (TRTB) and 48 V (TRTC) · Not stabilised

Measurements

Output current A	Output voltage 12 V (DC) not stabilised TRTA								Output voltage 24 V (DC) not stabilised TRTB								Output voltage 48 V (DC) not stabilised TRTC							
	Ref.	External dimensions mm			Fastening elements mm			Weight kg	Ref.	External dimensions mm			Fastening elements mm			Weight kg	Ref.	External dimensions mm			Fastening elements mm			Weight kg
		A	B	C	D	E	∅			A	B	C	D	E	∅			A	B	C	D	E	∅	
10	TRTA10	205	147	165	126	103	7	8.3	TRTB10	205	147	165	126	103	7	9.3	TRTC10	205	147	180	126	103	7	11
16	TRTA16	205	147	165	126	103	7	9.3	TRTB16	205	147	180	126	103	7	11	TRTC16	238	195	205	177	150	9	18
25	TRTA25	205	147	180	126	103	7	11	TRTB25	238	185	205	177	150	9	18	TRTC25	280	365	220	80	250	9	25
40	TRTA40	238	195	205	177	150	9	18	TRTB40	280	365	220	80	250	9	25	TRTC40	340	450	255	106	310	9	40.2
63	TRTA63	280	365	220	80	250	9	25	TRTB63	340	440	255	96	310	9	37.8	TRTC63	340	480	255	136	310	9	52.9
100	TRTA100	340	440	255	96	310	9	37.8	TRTB100	340	470	255	126	310	9	49.3	TRTC100	410	480	305	136	380	11	73
160	TRTA160	340	470	255	126	310	9	49.3	TRTB160	410	460	305	116	380	11	73	TRTC160	490	820	355	162	460	11	137
250	TRTA250	410	460	305	116	380	11	73	TRTB250	490	780	355	142	460	11	118	TRTC250	540	1090	405	164	510	11	178
400	TRTA400	490	780	355	142	460	11	118	TRTB400	540	1070	405	144	510	11	157	TRTC400	540	11130	405	204	510	11	219
500	TRTA500	490	820	355	162	460	11	137	TRTB500	540	1090	405	164	510	11	178	TRTC500	670	1180	645	210	426	13	311
630	TRTA630	540	1070	405	144	510	11	157	TRTB630	540	1110	405	184	510	11	198	TRTC630	670	1200	645	210	426	13	335
800	TRTA800	540	1090	405	164	510	11	178	TRTB800	540	11130	405	204	510	11	219	TRTC800	670	1220	645	210	426	13	352
1000	TRTA1000	540	1110	405	184	510	11	198	TRTB1000	670	1180	645	210	426	13	311	TRTC1000	785	1270	850	460	472	17	492

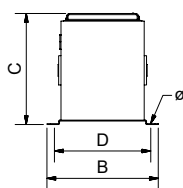
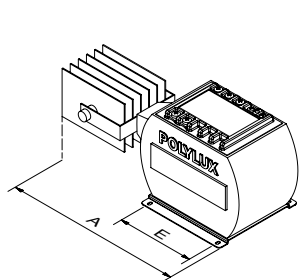

Up to 16 A

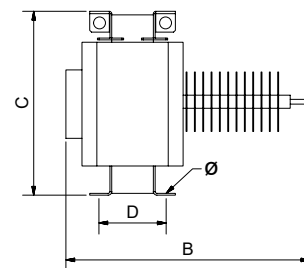
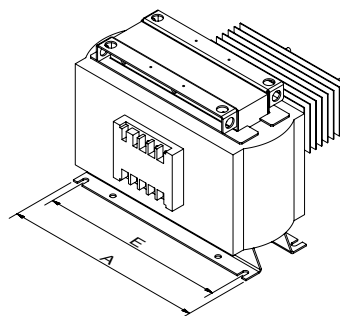

From 25 A

On-request manufacturing options (please see prices)

Output current	From 10 A to 1000 A
Windings	Copper or aluminium
Frequency	From 50 Hz to 400 Hz
Connection unit	Yyn0, Dyn11, Dd0, Dy1, Dyn5, Yn1/5/11... (See Technical Appendix T.A.2)
Test voltage	Up to 28 kV
Short circuit voltage	From 2% to 9%
Operation	Intermittent, continuous
Electrostatic shield	Up to three shields
Altitude	Up to 4000 m
Protections	In both primary and secondary (figure 1)
Temperature sensors	PT100 (figure 2), PTC (figure 3) or bimetallic



Figure 1



Figure 2



Figure 3



TRT SERIES

Encapsulated rectifiers · Input 400 V · Output in DC 12 V (TRTA), 24 V (TRTB) and 48 V (TRTC) · Not stabilised

Feature plate structure

Primary connection

LED indicator lamp

Primary voltage

Klixon 120 °C thermostat connection

Output current

Transformer type symbol

Output voltage

CE declaration of conformity

EAN bar code

Standard

Frequency

Primary protection

Reference

Insulators

Serial number

Test voltage

Connection unit

IP rating

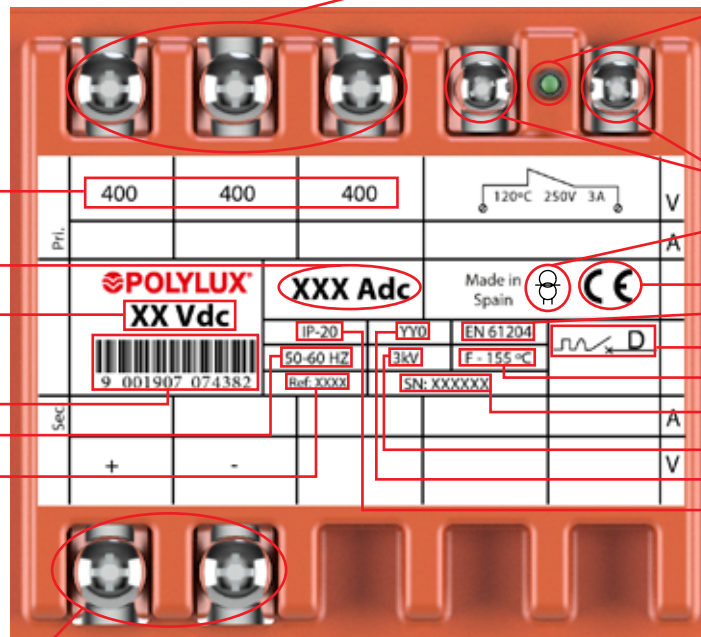

Secondary connection



FCP SERIES

Switched single-phase



Definition and applications

The FCP series consists of power sources designed for all those application that require a continuous power supply. Thanks to their compact and functional design, they are easy to connect and provide an economical solution.

Manufacturing characteristics

All the versions have the following features in common:

- High power density
- Universal input range
- Mounting on **DIN rail**.
- Protection against surge currents, overload and short circuit
- All the power sources are checked automatically one by one and a compliance report is created based on the respective standard.

Technical features - standard model

Power	2 Adc to 20 Adc (output 12 V) 1 Adc to 15 Adc (output 24 V)
Standard output voltage	FCPB: 12 V (DC) FCP: 24 V (DC)
Standard frequency	47-63 Hz
Room temperature	45 °C
IP rating	IP20
Mounting	Mounting on DIN 46277/3 rail
Standards	EN550011, EN55022, EN61000, EN 60950, UL 508

Derating curve

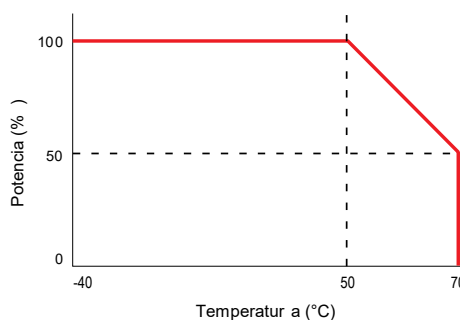

Theoretical data - standard model

Output current A (DC)	Reference	Input voltage V (AC)	Output voltage V(DC)
FCPB			
2	FCPB2	100-240	12
4	FCPB4	100-240	12
6	FCPB6	100-240	12
10	FCPB10	100-240	12
20	FCPB20	100-240	12
FCP			
1	FCP1	100-240	24
2	FCP2	100-240	24
3	FCP3	100-240	24
5	FCP5	100-240	24
10	FCP10	100-240	24
15	FCP15	100-240	24

Measurements

Reference	External dimensions mm			Weight kg	Figure
	A	B	C		
FCPB					
FCPB2	45	75	97	0.16	1
FCPB4	45	75	97	0.23	1
FCPB6	56	121	110	0.52	2
FCPB10	75	121	110	0.59	2
FCPB20	100	121	110	1.12	3
FCP					
FCP1	45	74	97	0.15	1
FCP2	45	74	97	0.23	1
FCP3	56	121	110	0.51	2
FCP5	75	121	110	0.58	2
FCP10	100	121	110	1.1	3
FCP15	100	121	110	1.1	3

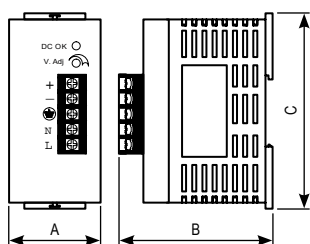

Figure 1

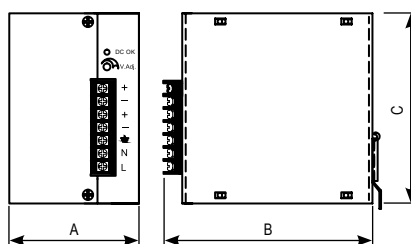

Figure 2

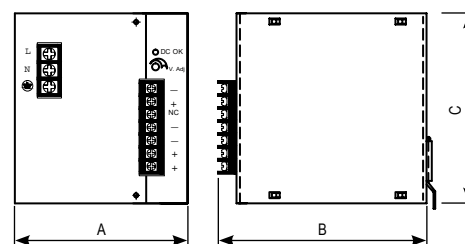

Figure 3

FCPT SERIES

Switched three-phase



Definition and applications

The FCPT series are three-phase power sources designed for all those applications that require a continuous power supply such as automatic control systems, instrumentation equipment, electromagnetic actuators and other CC motor loads. Thanks to their compact and functional design, they are easy to connect and provide an economical solution.

Manufacturing characteristics

All the versions have the following features in common:

- High power density
- Universal input range
- Mounting on **DIN rail**.
- Protection against surge currents, overload and short circuit
- All the power sources are checked automatically one by one and a compliance report is created based on the respective standard.

Technical features - standard model

Power	20 Adc (FCPT20) 40 Adc (FCPT40)
Standard output voltage	24 V (DC)
Standard frequency	47-63 Hz
Room temperature	45 °C
IP rating	IP20
Mounting	Mounting on DIN 46277/3 rail
Standards	EN550011, EN55022, EN61000, EN 60950, UL 508

Derating curve

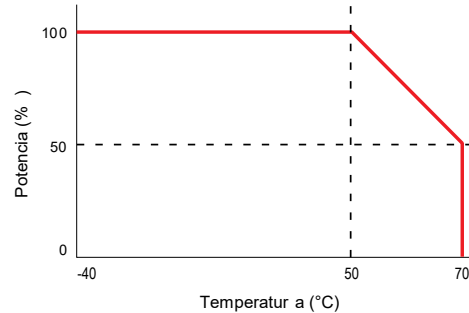

Theoretical data - standard model

Output current A (DC)	Reference	Input voltage V (AC)	Output voltage V(DC)
20	FCPT20	370-430	24
40	FCPT40	370-430	24

Measurements

Reference	External dimensions mm			Weight kg
	A	B	C	
FCPT20	142	110	110	1.10
FCPT40	156	110	110	1.3

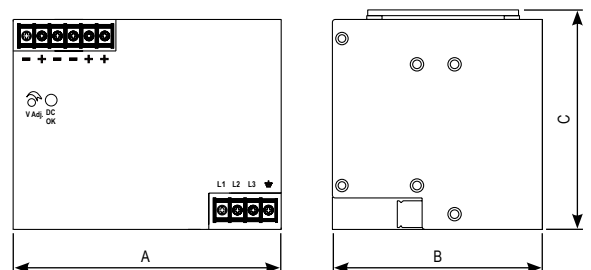

TH SERIES

Isolation transformers for clinical electrical installations · Input 230 V · Output 230 V



Definition and applications

Our TH series is manufactured in accordance with the IEC/EN 61558-2-15 standard and is focused on safety in instalations for clinical use, guaranteeing patient safety.

Manufacturing characteristics

- Anti-flash varnish finish.
- Safety Class I.
- Hoisting bolts, bimetallic contact against overtemperature and electrostatic shield included.
- Leakage current <0,5 mA between secondary and ground.
- All the transformers are checked automatically one by one and the compliance test report is created in accordance with the corresponding standard.



THX

- IP00 protection rating.
- Total impregnated in anti-flash varnish.
- Hoisting elements included.



THW

- IP23 rating (IK08).
- Metal box painted with polyester resin.
- High resistance to corrosion.
- Hoisting elements included.
- Detachable top and front cover.
- Cable outlet with cable gland.



TH

- **Encapsulated in flame retardant resin.**
- IP20 protection rating.
- Protection against damp, saline and corrosive environments.
- Greater resistance to surge currents.
- Greater resistance to transient harmonics.
- Greater mechanical resistance to undesirable vibrations.
- Uniform heat dissipation.
- Hoisting elements included.



Technical features - standard model

Power	1 kVA to 10 kVA
Standard voltage	Input 230 V // Output 230 V
Standard frequency	50-60 Hz
Noise	≤ 35 dB
Windings	Class HC-200 °C
Insulators	Class F - 155 °C <small>*More information in Technical Appendix (T.A.1)</small>
Class	I
Altitude	1000 m
Enclosure colour	RAL 7035
IP rating	IP00 (THX) IP20 (TH) IP23 (THW)
IK protection rating	IK08 (THW)
Paint class (ISO 12944)	C3 (THW)
Room temperature	45 °C
Standards	IEC/EN/UNE-EN 61558-2-15, CE
Test voltage	3.5 kV (1 min., 50 Hz)
Inrush	< 8 In
Ucc	≤ 4,4 %
K factor	4
Operation	Continuous
Cooling	AN (THX / TH) - ANAN (THW)
Hoisting accessories	Hoisting elements

Electrical diagram

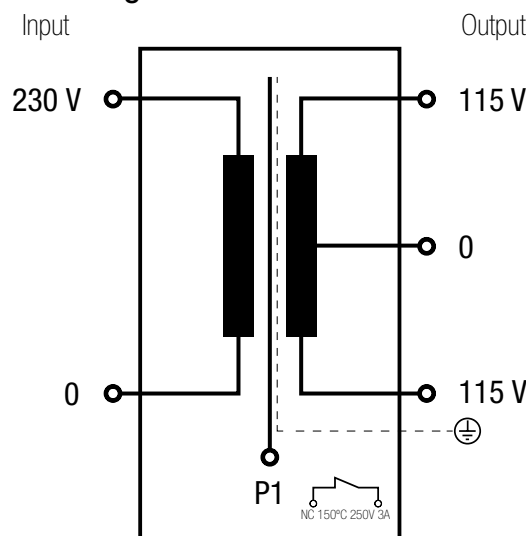

***Klixon 150°C 250 V 3 A included**



TH SERIES

Isolation transformers for clinical electrical installations · Input 230 V · Output 230 V

Connection

- U1 = 0
- V1 = 230 V
- U2 = 115 V
- V2 = 115 V
- K1 = Klixon 150 °C thermostat for first coil
- K2 = Klixon 150 °C thermostat for second coil
- P.E = electrostatic shield

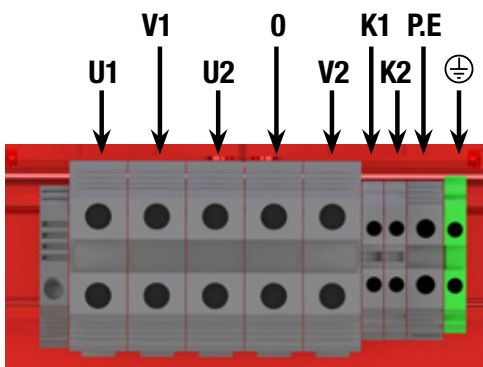

Terminal types

Terminals	Dimensions mm				Maximum cross-section conductor mm ²	Maximum tightening torque		THX-THW Power VA		TH Power VA	
	A	B	C	Ø		N-m	Lb-In	From	To	From	To
Terminal M6	15	18.5	14	M6	-	1.1	9.7	-	-	1000	4000
Terminal 4	-	-	-	-	6	0.5	4.4	1000	1000	-	-
Terminal 16	-	-	-	-	25	1.2	10.6	2000	4000	-	-
Terminal 35	-	-	-	-	50	2.5	22.1	5000	10000	5000	10000

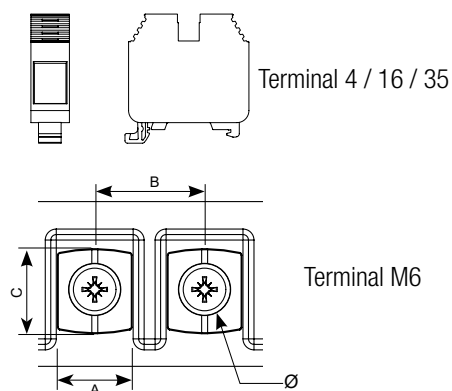

Theoretical data - standard model

Power kVA	Reference	Insulation class	Current A		Protections A		Cable gland	
			Input	Output	Input	Output	Ø max. (mm)	Quantity
THX								
1	THX1000	F	4.5	4.5	10 (D/aM)	4 (C/gG)	-	-
2	THX2000	F	8.7	8.7	20 (D/aM)	8 (-/gG)	-	-
3.15	THX3150	F	13.7	13.7	32 (D/aM)	12 (-/gG)	-	-
4	THX4000	F	17.4	17.4	40 (D/aM)	16 (C) / 12 (gG)	-	-
5	THX5000	F	21.7	21.7	50 (D/aM)	20 (C/gG)	-	-
6.3	THX6300	F	27.4	27.4	63 (D/aM)	25 (C/gG)	-	-
8	THX8000	F	34.8	34.8	80 (D/aM)	32 (C) / 30 (gG)	-	-
10	THX10000	F	43.5	43.5	100 (D/aM)	40 (C/gG)	-	-
THW								
1	THW1000	F	4.5	4.5	10 (D/aM)	4 (C/gG)	14	2
2	THW2000	F	8.7	8.7	20 (D/aM)	8 (-/gG)	18	2
3.15	THW3150	F	13.7	13.7	32 (D/aM)	12 (-/gG)	18	2
4	THW4000	F	17.4	17.4	40 (D/aM)	16 (C) / 12 (gG)	18	2
5	THW5000	F	21.7	21.7	50 (D/aM)	20 (C/gG)	25	4
6.3	THW6300	F	27.4	27.4	63 (D/aM)	25 (C/gG)	25	4
8	THW8000	F	34.8	34.8	80 (D/aM)	32 (C) / 30 (gG)	32	4
10	THW10000	F	43.5	43.5	100 (D/aM)	40 (C/gG)	32	4
TH								
1	TH1000	F	4.5	4.5	10 (D/aM)	4 (C/gG)	-	-
2	TH2000	F	8.7	8.7	20 (D/aM)	8 (-/gG)	-	-
3.15	TH3150	F	13.7	13.7	32 (D/aM)	12 (-/gG)	-	-
4	TH4000	F	17.4	17.4	40 (D/aM)	16 (C) / 12 (gG)	-	-
5	TH5000	F	21.7	21.7	50 (D/aM)	20 (C/gG)	-	-
6.3	TH6300	F	27.4	27.4	63 (D/aM)	25 (C/gG)	-	-
8	TH8000	F	34.8	34.8	80 (D/aM)	32 (C) / 30 (gG)	-	-
10	TH10000	F	43.5	43.5	100 (D/aM)	40 (C/gG)	-	-



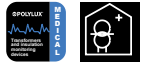

TH SERIES

Isolation transformers for clinical electrical installations · Input 230 V · Output 230 V

Measurements

Power kVA	Reference	External dimensions mm			Fastening elements mm			Weight kg
		A	B	C	D	E	Ø	
THX								
1	THX1000	160	128	253	100	140	9	13.9
2	THX2000	200	164	303	155	154	9	26
3.5	THX3150	240	140	355	112	180	9	27.3
4	THX4000	240	160	355	122	180	9	30.7
5	THX5000	240	170	355	142	180	9	38.5
6.3	THX6300	280	190	405	126	210	9	39.7
8	THX8000	280	210	405	146	210	9	52.6
10	THX10000	280	220	405	156	210	9	65.9
THW								
1	THW1000	315	230	315	205	200	6	17.9
2	THW2000	385	260	384	245	250	6	28.5
3.5	THW3150	458	340	500	300	300	12	34.7
4	THW4000	458	340	500	300	300	12	38.3
5	THW5000	458	340	500	300	300	12	44.6
6.3	THW6300	528	418	644	375	345	12	50
8	THW8000	528	418	644	375	345	12	65
10	THW10000	528	418	644	375	345	12	74
TH								
1	TH1000	190	180	205	115	160	9	21.7
2	TH2000	200	164	303	155	154	9	33
3.5	TH3150	240	140	355	112	180	9	34.3
4	TH4000	240	160	355	122	180	9	40.2
5	TH5000	240	170	355	142	180	9	48
6.3	TH6300	280	190	405	126	210	9	49.2
8	TH8000	280	210	405	146	210	9	69.6
10	TH10000	280	220	405	156	210	9	82.9

THX IP00

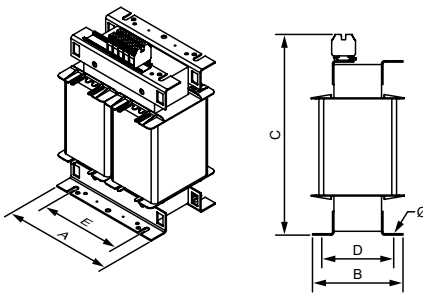

THW IP23

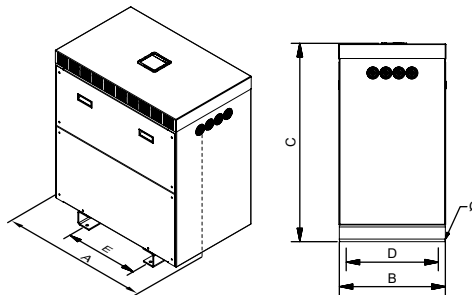

TH IP20

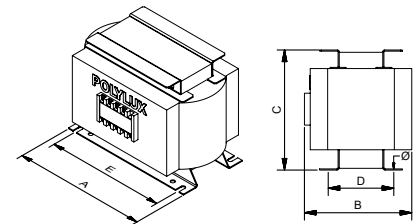

From 0.4 kVA to 1 kVA

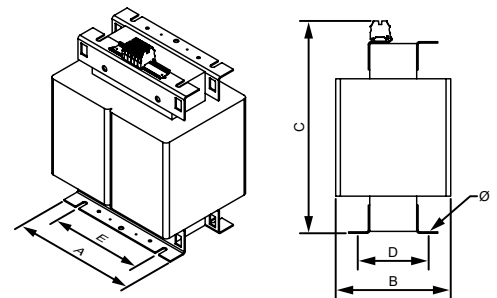

From 4 kVA



TH SERIES

Isolation transformers for clinical electrical installations · Input 230 V · Output 230 V

Feature plate structure

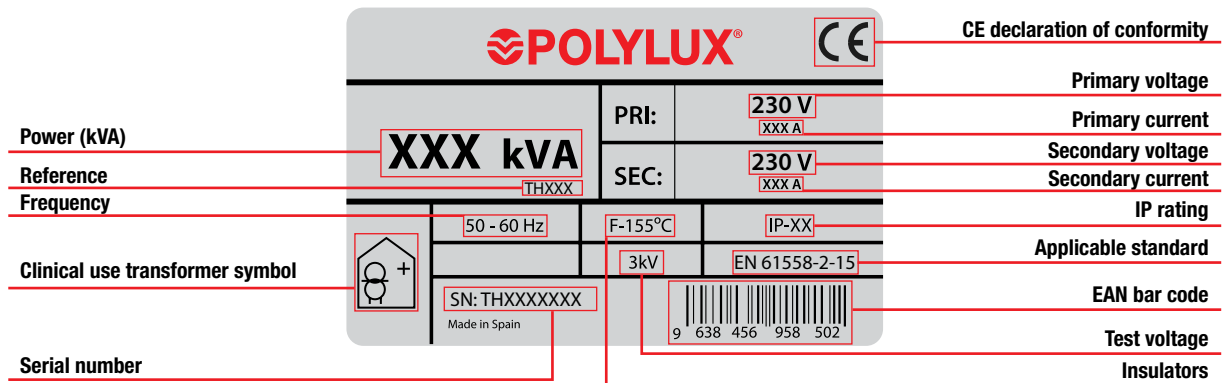

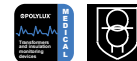

TLQ SERIES

For operating theatre spotlights · Input $230 \pm 5\% \text{ V}$ · Output 0-24 / 25 / 26 / 27 V



Definition and applications

Our TLQ series consists of single-phase isolation transformers specially designed for operating theatre spotlights.

Manufacturing characteristics

- All the versions have the following features in common:
- Copper shield between primary and secondary with ground screw connection, which prevents crossovers with network voltage shunts to secondary, thus preventing electrical risks for persons.
 - Anti-flash dip varnishing. Ensures greater compactation, insulation and noise elimination.
 - Connection terminals made of copper, welded and inserted in blocks to prevent hazards caused by expansion that may lead to poor connection.
 - Option of mounting on **DIN rail up to 160 VA**.
 - IP20 enclosure, V-0 flame-retardant polymer box that complies with UL94.
 - Safety Class I, convertible to Class II.
 - All the transformers are checked automatically one by one and the compliance test report is created in accordance with the corresponding standard.

NEW head design

- Increased wiring insulation.
- Clearer features.
- Easier connection.
- More uniform, compact and robust design.



Technical features - standard model

Power	160 VA to 800 VA
Insulators	Class B - 130 °C
Winding	Class HC - 200 °C
Room temperature	45 °C
Frequency	50-60 Hz
Noise	≤ 45 dB
Protection rating	IP20
Cooling	ANAN
Includes	LED indicator lamp Electrostatic shield
Mounting	Mounting on DIN 46277/3 rail (up to 160 VA)
Standards	IEC/EN/UNE-EN 61558-1, CE
Protection	Convertible from Class I to Class II
Operation	Continuous
Test voltage	2.5 kV (1 min., 50 Hz)

Electrical diagram

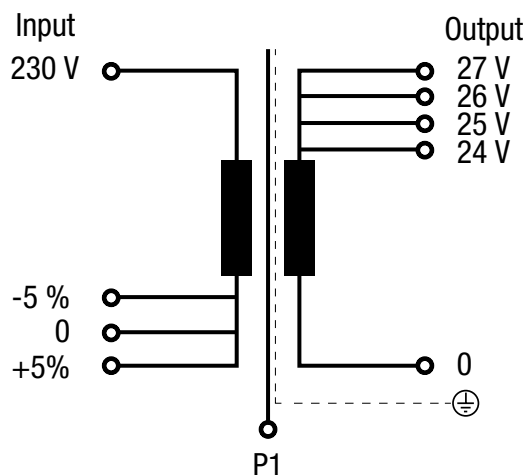



TLQ SERIES

For operating theatre spotlights · Input **230±5% V** · Output **0-24 / 25 / 26 / 27 V**

Electrical connection

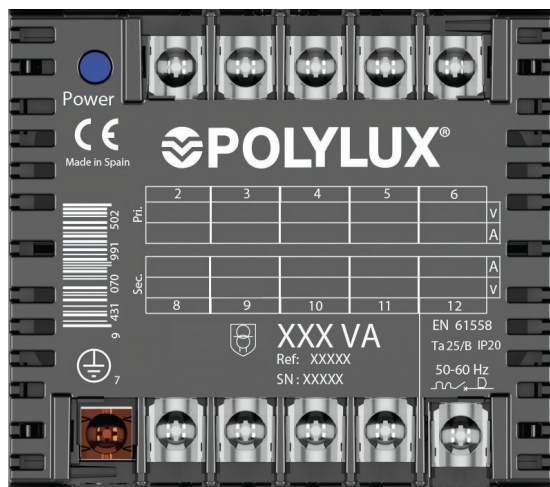

Input:

- 230-5% V | Connection: 2-3
- 230 V | Connection: 2-4
- 230+5% V | Connection: 2-5

Output:

- 24 V | Connection: 8-9
- 25 V | Connection: 8-10
- 26 V | Connection: 8-11
- 27 V | Connection: 8-12

Terminal types

Terminal blocks	External mm				Maximum tightening torque N·m	Primary Power VA		Secondary Power VA	
	A	B	C	Ø		From	To	From	To
	Terminal M4	10	13.5	12		M4	1.1	160	800
Terminal M5	15	18.5	14	M5	2.5	-	-	315	800

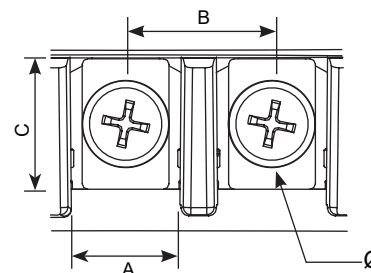

Theoretical data - standard model

Power VA	Reference	Input current A		Output current A				Input protections (A) (MCB -> D / Fuse -> aM)		Output protections (A) (MCB -> C / Fuse -> gG)			
		230-5% V	230+5% V	24 V	25 V	26 V	27 V	230-5% V	230+5% V	24 V	25 V	26 V	27 V
160	TLQ160	0.73	0.66	6.67	6.40	6.15	5.93	2	2	6	6	6	5
315	TLQ315	1.44	1.30	13.13	12.60	12.12	11.67	3	3	12	12	12	10
630	TLQ630	2.88	2.61	26.25	25.20	24.23	23.33	10	10	25	25	20	20
800	TLQ800	3.66	3.31	33.33	32.00	30.77	29.63	10	10	30	30	30	25

Power VA	Reference	Maximum cross-section input conductor(mm²)				Maximum cross-section output conductor (mm²)							
		230-5% V		230+5% V		24 V		25 V		26 V		27 V	
		Flexible	Rigid	Flexible	Rigid	Flexible	Rigid	Flexible	Rigid	Flexible	Rigid	Flexible	Rigid
160	TLQ160	0.5	1	0.5	1	1.5	2	1.5	2	1.5	2	1.5	2
315	TLQ315	0.5	1	0.5	1	2.5	4	2.5	4	2.5	4	2.5	4
630	TLQ630	1	1.5	1	1.5	6	-	6	-	6	-	6	-
800	TLQ800	1	1.5	1	1.5	8	-	8	-	8	-	6	-



TLQ SERIES

For operating theatre spotlights · Input $230 \pm 5\% V$ · Output 0-24 / 25 / 26 / 27 V

Measurements

Power VA	Ref.	External dimensions mm			Fastening elements mm			Weight kg
		A	B	C	D	E	Ø	
160	TLQ160	106	123	118	110	74	5	2.3
315	TLQ315	118	138	131	121	88	6	4.1
630	TLQ630	136	162	156	145	104	6	6.8
800	TLQ800	136	162	180	145	104	6	10

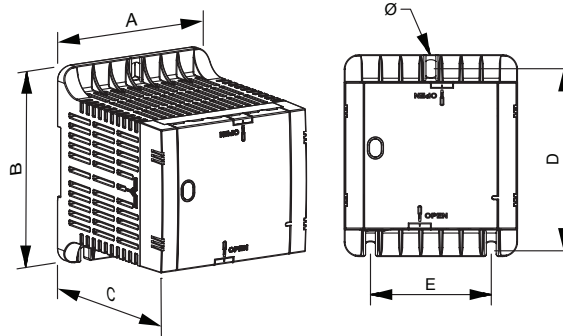

On-request manufacturing options (please see prices)

Power	From 160 VA to 800 VA
Protections	Primary fuse
Shields	Primary / secondary, primary / ground and secondary / ground

Feature plate structure

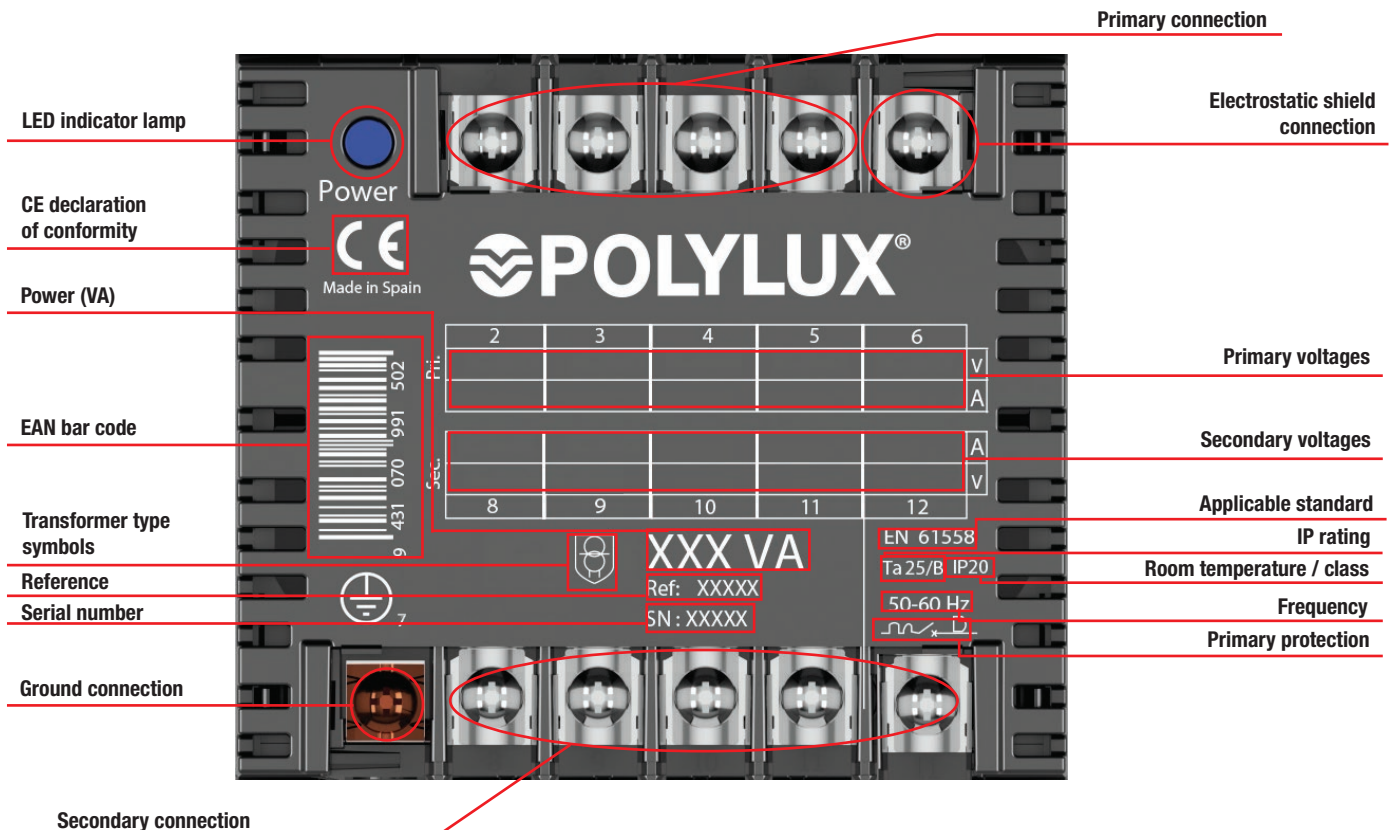



TTH SERIES

Insulation for clinical electrical installations · Input **400 V** · Output **230 V**

Definition and applications

Our TTH series is manufactured in accordance with the IEC/EN 61558-2-15 standard, focused on safety in clinical installations, and guaranteeing patient safety.



TTHX

- IP00 protection rating.
- Power from 1 kVA to 10 kVA.
- Total impregnated in anti-flash varnish.
- Hoisting elements included.



TTH

- **Encapsulated in resin**
- IP20 protection rating.
- Power from 0.40 kVA to 400 kVA.
- Protection against damp, saline and corrosive environments.
- Greater resistance to surge currents.
- Greater resistance to transient harmonics.
- Greater mechanical resistance to undesirable vibrations.
- Uniform heat dissipation.
- Hoisting elements included.

Manufacturing characteristics

- All the transformers are dipped in anti-flash varnish and then compacted in the furnace. This process increases the insulation grade, reduces noise and provides anti-moisture, waterproofed protection.
- All the transformers are checked automatically one by one and the compliance test report is created in accordance with the corresponding standard.



TTHW

- IP23 rating (IK08).
- Power from 1 kVA to 10 kVA.
- Metal box painted with RAL7035 polyester resin.
- High resistance to corrosion.
- Cable outlet with cable gland.
- Hoisting elements included.
- Detachable top and front cover.
- Cable outlet with cable gland.

Electrical diagram

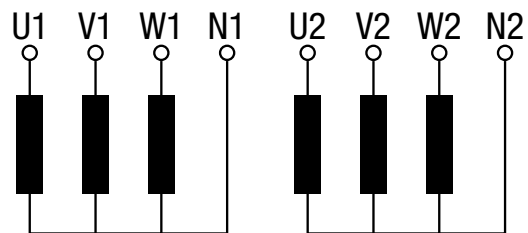

YNyn0

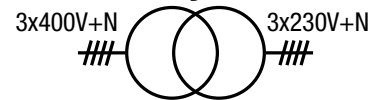

Technical features - standard model

Power	1 kVA to 10 kVA
Standard voltage	Input 400 V and N // Output 230 V and N.
Standard frequency	50-60 Hz
Connection unit	YNyn0
Windings	Class HC-200 °C
Insulators	Class F - 155 °C <small>*More information in Technical Appendix (T.A.1)</small>
Class	I
Altitude	1000 m
Enclosure colour	RAL 7035
IP rating	IP00 (TTHX) IP20 (TTH) IP23 (TTHW)
IK rating	IK08 (TTHW)
Paint class (ISO 12944)	C3 (TTHW)
Room temperature	45 °C
Standards	IEC/EN 61558-2-15, CE
Test voltage	4.5 kV (1 min., 50 Hz)
Inrush	< 12 In
Ucc	≤ 4 %
K factor	4
Operation	Continuous
Cooling	AN (TTHX / TTH) - ANAN (TTHW)

Connection

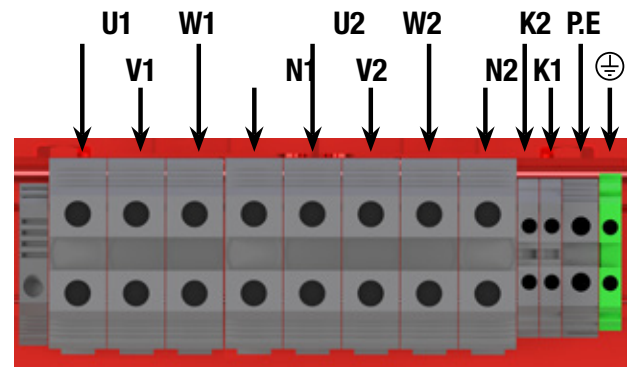

- U1 = 400 V
- V1 = 400 V
- W1 = 400 V
- N1 = Neutral 1
- U2 = 230 V
- V2 = 230 V
- W2 = 230 V
- N2 = Neutral 2

- K1 = Klixon 150 °C thermostat for first coil
- K2 = Klixon 150 °C thermostat for second coil
- P.E = electrostatic shield





TTH SERIES

Insulation for clinical electrical installations · Input 400 V · Output 230 V

Terminal types

Terminals	Maximum cross-section conductor mm ²	Maximum tightening torque		TTHX-TTHW	
		N-m	Lb-In	Power kVA	
				From	To
Terminal 4	6	0.5	4.4	1	2
Terminal 10	16	1.2	10.6	3.15	4
Terminal 16	25	1.2	10.6	5	6
Terminal 35	50	2.5	22.1	8	10

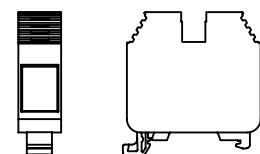

Terminal 4 / 10 / 16 / 35

Terminals	External mm				Maximum cross-section conductor mm ²	Maximum tightening torque		TTH	
	A	B	C	Ø		N-m	Lb-In	Power kVA	
								From	To
Terminal M5	15	18.5	14	M5	-	1.1	9.7	1	6.3
Terminal 35	-	-	-	-	50	2.5	22.1	8	10

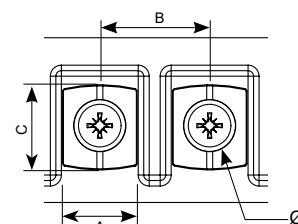

Terminal M5

Theoretical data - standard model

Power kVA	Reference	Insulation class	Current A		Protections A		Noise dB	Cable gland	
			Input	Output	Input	Output		Ø max. (mm)	Quantity
TTHX									
1	TTHX1	F	1.4	2.5	3 (D/Am)	2.5 (C/gG)	≤45	-	-
2	TTHX2	F	2.9	5.0	10 (D/Am)	5 (C/gG)	≤45	-	-
3.15	TTHX3.15	F	4.5	7.9	10 (D/Am)	7 (C/gG)	≤45	-	-
4	TTHX4	F	5.8	10.0	16 (D/Am)	10 (C/gG)	≤45	-	-
5	TTHX5	F	7.2	12.6	16 (D/Am)	12 (C/gG)	≤45	-	-
6.3	TTHX6.3	F	9.1	15.8	20 (D/Am)	12 (C/gG)	≤45	-	-
8	TTHX8	F	11.5	20.1	25 (D/Am)	20 (C/gG)	≤45	-	-
10	TTHX10	F	14.4	25.1	32 (D/Am)	25 (C/gG)	≤45	-	-
TTHW									
1	TTHW1	F	1.4	2.5	3 (D/Am)	2.5 (C/gG)	≤45	14	2
2	TTHW2	F	2.9	5.0	10 (D/Am)	5 (C/gG)	≤45	14	2
3.15	TTHW3.15	F	4.5	7.9	10 (D/Am)	7 (C/gG)	≤45	18	2
4	TTHW4	F	5.8	10.0	16 (D/Am)	10 (C/gG)	≤45	18	2
5	TTHW5	F	7.2	12.6	16 (D/Am)	12 (C/gG)	≤45	25	4
6.3	TTHW6.3	F	9.1	15.8	20 (D/Am)	12 (C/gG)	≤45	25	4
8	TTHW8	F	11.5	20.1	25 (D/Am)	20 (C/gG)	≤45	25	4
10	TTHW10	F	14.4	25.1	32 (D/Am)	25 (C/gG)	≤45	25	4
TTH									
1	TTH1	F	1.4	2.5	3 (D/Am)	2.5 (C/gG)	≤45	-	-
2	TTH2	F	2.9	5.0	10 (D/Am)	5 (C/gG)	≤45	-	-
3.15	TTH3.15	F	4.5	7.9	10 (D/Am)	7 (C/gG)	≤45	-	-
4	TTH4	F	5.8	10.0	16 (D/Am)	10 (C/gG)	≤45	-	-
5	TTH5	F	7.2	12.6	16 (D/Am)	12 (C/gG)	≤45	-	-
6.3	TTH6.3	F	9.1	15.8	20 (D/Am)	12 (C/gG)	≤45	-	-
8	TTH8	F	11.5	20.1	25 (D/Am)	20 (C/gG)	≤45	-	-
10	TTH10	F	14.4	25.1	32 (D/Am)	25 (C/gG)	≤45	-	-

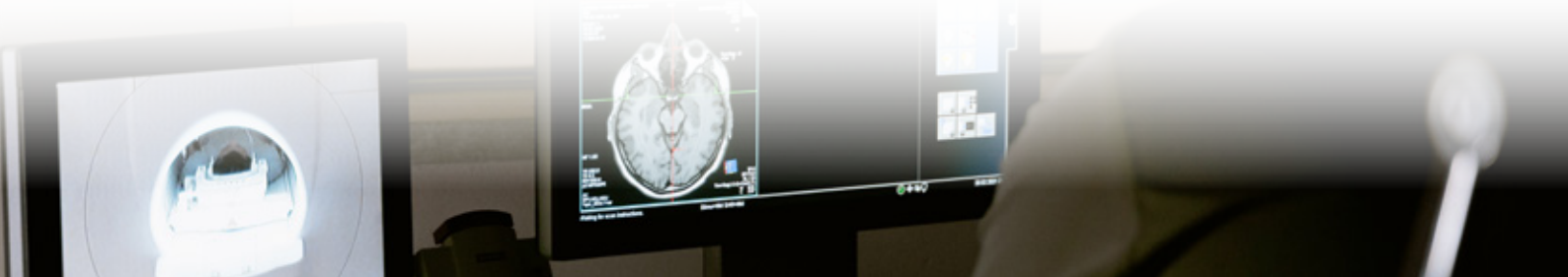



TTH SERIES

Insulation for clinical electrical installations · Input 400 V · Output 230 V

Measurements

Power kVA	Reference	External dimensions mm			Fastening elements mm			Weight kg
		A	B	C	D	E	∅	
TTHX								
1	TTHX1	240	108	253	80	200	9	16
2	TTHX2	240	128	253	100	200	9	22
3.15	TTHX3.15	300	154	303	145	250	9	36
4	TTHX4	300	164	303	155	250	9	41
5	TTHX5	360	144	353	122	300	11	56
6.3	TTHX6.3	360	164	353	142	300	11	68
8	TTHX8	360	240	353	172	300	11	71
10	TTHX10	360	270	353	202	300	11	87

Power kVA	Reference	External dimensions mm			Fastening elements mm			Weight kg
		A	B	C	D	E	∅	
TTHW								
1	TTHW1	315	230	315	205	200	6	20.3
2	TTHW2	315	230	315	205	200	6	28.2
3.15	TTHW3.15	385	260	384	245	250	6	40.8
4	TTHW4	385	260	384	245	250	6	45.2
5	TTHW5	458	340	500	300	300	12	61
6.3	TTHW6.3	458	340	500	300	300	12	73
8	TTHW8	458	340	500	300	300	12	76
10	TTHW10	458	340	500	300	300	12	92

TTHX IP00

TTHW IP23

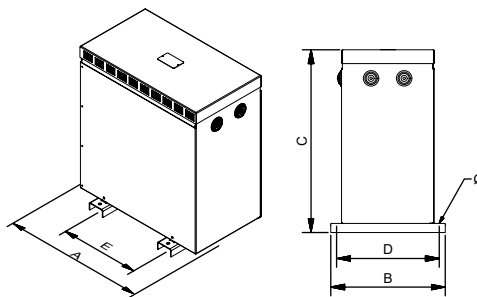
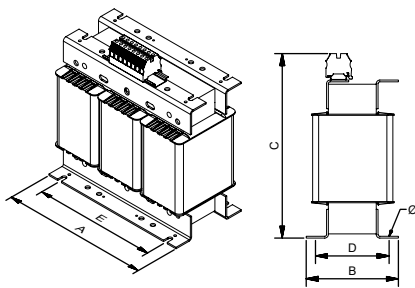

Sectioned

Power kVA	Reference	External dimensions mm			Fastening elements mm			Weight kg
		A	B	C	D	E	∅	
TTH								
1	TTH1	300	124	303	115	250	9	34,5
2	TTH2	300	134	303	125	250	9	39,5
3.15	TTH3.15	300	154	303	145	250	9	47,5
4	TTH4	300	164	303	155	250	9	52,5
5	TTH5	360	144	353	122	300	11	70,4
6.3	TTH6.3	360	164	353	142	300	11	82,4
8	TTH8	360	240	353	172	300	11	85,4
10	TTH10	360	270	353	202	300	11	101,4

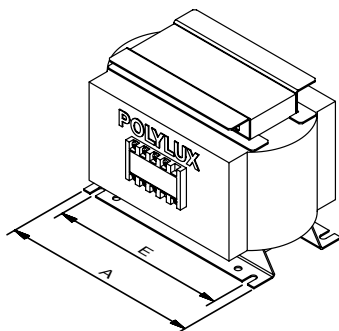

Up to 6.3 kVA

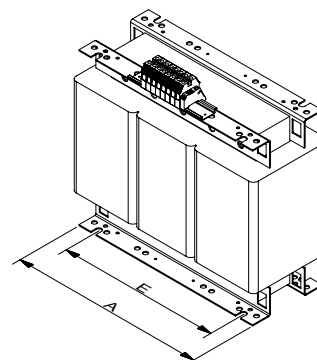
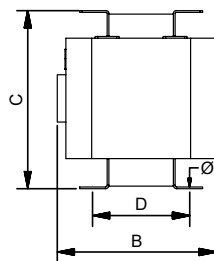

From 8 kVA

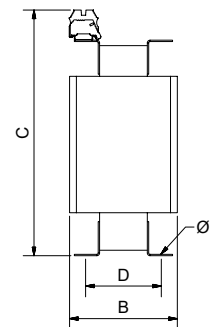



TTH SERIES

Insulation for clinical electrical installations · Input 400 V · Output 230 V

Feature plate structure

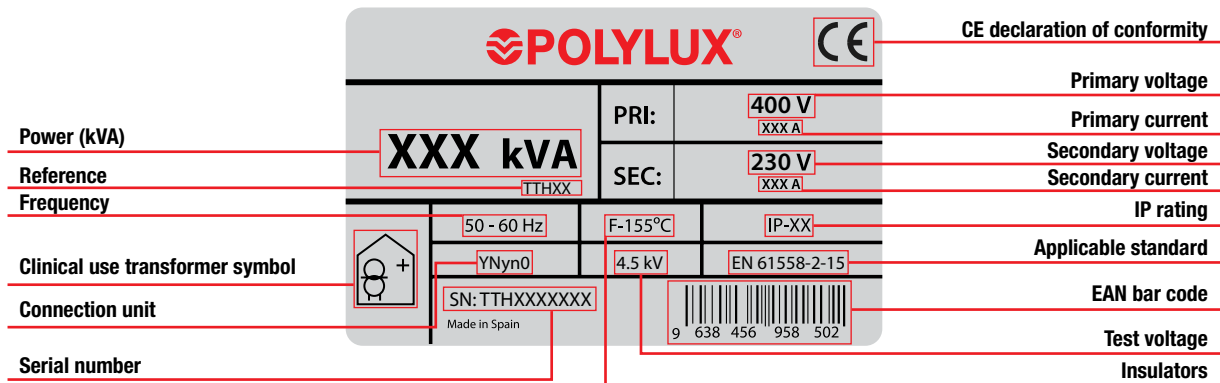



TTFK SERIES

Insulation for three-phase harmonic networks · Input **400 V** · Output **400 V + N**

Definition and applications

The TTFK series is comprised of insulation transformers for three-phase networks with high levels of harmonics.

These “k” factor transformers are used to withstand overheating produced by non-linear load harmonics.

A k=13 factor transformer is used when the harmonic load represents 30% of the total load.

A k=20 factor transformer is used with the harmonic load represents 60% of the total load.



TTFKX

- IP00 protection rating.
- Power from 10 kVA to 500 kVA.
- Total impregnated in anti-flash varnish.
- Hoisting elements included.



TTFKW

- IP23 rating (IK08).
- Power from 10 kVA to 500 kVA.
- Metal box painted with RAL7035 polyester resin.
- High resistance to corrosion.
- Cable outlet with cable gland.
- Hoisting elements included.
- Detachable top and front cover.



TTFKZ

- IP54 rating / 65 (IK10).
- Power from 10 kVA to 500 kVA.
- Metal box painted with RAL7035 polyester resin.
- High resistance to corrosion.
- Stuffing box cover for cable input depending on installation needs.
- Hoisting elements included.
- Detachable top cover.
- With silentblock.

Technical features - standard model

Power	10 kVA to 500 kVA
Standard voltage	Input 400 V // Output 400 V and N.
Standard frequency	50-60 Hz
Connection unit	Dyn11
Windings	Class HC-200 °C
Insulators	Class F - 155 °C ≤ 25 kVA (20 kVA TTFKZ) Class H - 180 °C ≥ 31,5 kVA (25 kVA TTFKZ) <small>*More information in Technical Appendix (T.A.1)</small>
Class	I
Altitude	1000 m
Enclosure colour	RAL 7035
IP rating	IP00 (TTFKX) IP23 (TTFKW) IP54 / 65 (TTFKZ)
IK rating	IK08 (TTFKW) IK10 (TTFKZ)
Paint class (ISO 12944)	C3 (TTFKW) C4 (TTFKZ)
Room temperature	45 °C
Standards	IEC/EN 61558, CE up to 31.5 kVA IEC/EN 60076, CE from 40 kVA
Test voltage	3 kV (1 min., 50 Hz)
Inrush	< 12 In
Ucc	≤ 4 %
K factor	13
Operation	Continuous
Cooling	AN (TTFKX) - ANAN (TTFKW / TTFKZ)

Electrical diagram

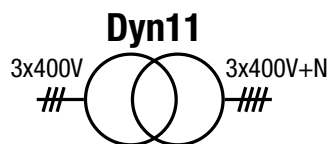
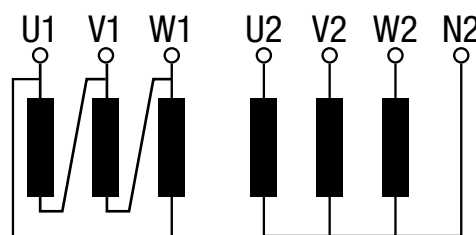

Connection

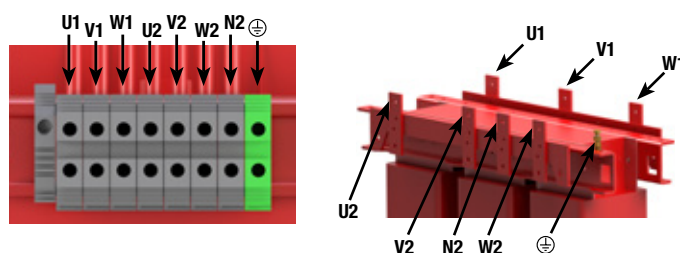



TTFK SERIES

Insulation for harmonic three-phase networks · Input **400 V** · Output **400 V + N**

Terminal types

Terminals	Maximum cross-section conductor mm ²	Maximum tightening torque		TTFKX-TTFKW-TTFKZ		
		N·m	Lb·In	From	To	
Power strip 1	Terminal 35	50	2.5	22.1	10	10
Power strip 2	Terminal 60	25	4.5	40	12.5	40
	Terminal 100	35	6.7	60	50	80
	Terminal 200	95	9	80	100	125
Connection plate	Plate 40 X 1	150	-	-	160	315
	Plate 60 X 2	150	-	-	400	400
	Plate 80 X 4	150	-	-	500	500

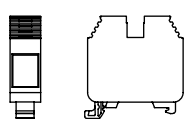

Power strip 1

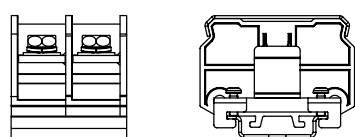

Power strip 2

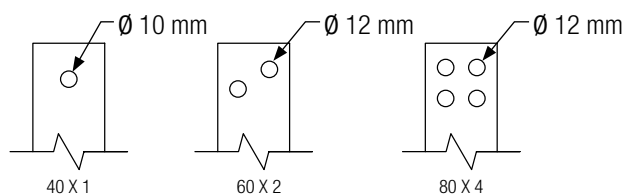

Plate connection

Theoretical data - standard model

Power kVA	Reference	Insulation class	Current A		Protections A		Noise dB
			Input	Output	Input	Output	
TTFKX							
10	TTFKX10	F	14.4	14.4	32 (D/Am)	12 (C/gG)	≤45
12.5	TTFKX12.5	F	18.0	18.0	40 (D/Am)	12 (C/gG)	≤45
16	TTFKX16	F	23.1	23.1	50 (D/Am)	20 (C/gG)	≤45
20	TTFKX20	F	28.9	28.9	63 (D/Am)	25 (C/gG)	≤45
25	TTFKX25	F	36.1	36.1	80 (D/Am)	30 (C/gG)	≤45
31.5	TTFKX31.5	H	45.5	45.5	100 (D/Am)	40 (C/gG)	≤45
40	TTFKX40	H	57.7	57.7	125 (D/Am)	50 (C/gG)	≤55
50	TTFKX50	H	72.2	72.2	160 (D/Am)	60 (C/gG)	≤55
63	TTFKX63	H	90.9	90.9	200 (D/Am)	80 (C/gG)	≤55
80	TTFKX80	H	115.5	115.5	300 (D/Am)	100 (C/gG)	≤55
100	TTFKX100	H	144.3	144.3	300 (D/Am)	100 (C/gG)	≤55
125	TTFKX125	H	180.4	180.4	400 (D/Am)	160 (C/gG)	≤55
160	TTFKX160	H	230.9	230.9	500 (D/Am)	200 (C/gG)	≤55
200	TTFKX200	H	288.7	288.7	600 (D/Am)	250 (C/gG)	≤55
250	TTFKX250	H	360.8	360.8	800 (D/Am)	300 (C/gG)	≤65
315	TTFKX315	H	454.7	454.7	1000 (D/Am)	400 (C/gG)	≤65
400	TTFKX400	H	577.4	577.4	1200 (D/Am)	500 (C/gG)	≤65
500	TTFKX500	H	721.7	721.7	1600 (D/Am)	800 (C/gG)	≤65



TTFK SERIES

Insulation for harmonic three-phase networks · Input **400 V** · Output **400 V + N**

Theoretical data - standard model

Power kVA	Reference	Insulation class	Current A		Protections A		Noise dB	Cable gland (TTFKW) / Stuffing boxes (TTFKZ)	
			Input	Output	Input	Output		ø max. (mm)	Quantity
TTFKW									
10	TTFKW10	F	14.4	14.4	32 (D/Am)	12 (C/gG)	≤45	32	4
12.5	TTFKW12.5	F	18.0	18.0	40 (D/Am)	12 (C/gG)	≤45	32	4
16	TTFKW16	F	23.1	23.1	50 (D/Am)	20 (C/gG)	≤45	32	4
20	TTFKW20	F	28.9	28.9	63 (D/Am)	25 (C/gG)	≤45	32	4
25	TTFKW25	F	36.1	36.1	80 (D/Am)	30 (C/gG)	≤45	32	4
31.5	TTFKW31.5	H	45.5	45.5	100 (D/Am)	40 (C/gG)	≤45	32	8
40	TTFKW40	H	57.7	57.7	125 (D/Am)	50 (C/gG)	≤55	32	8
50	TTFKW50	H	72.2	72.2	160 (D/Am)	60 (C/gG)	≤55	32	8
63	TTFKW63	H	90.9	90.9	200 (D/Am)	80 (C/gG)	≤55	44	8
80	TTFKW80	H	115.5	115.5	300 (D/Am)	100 (C/gG)	≤55	44	8
100	TTFKW100	H	144.3	144.3	300 (D/Am)	100 (C/gG)	≤55	44	8
125	TTFKW125	H	180.4	180.4	400 (D/Am)	160 (C/gG)	≤55	44	8
160	TTFKW160	H	230.9	230.9	500 (D/Am)	200 (C/gG)	≤55	44	8
200	TTFKW200	H	288.7	288.7	600 (D/Am)	250 (C/gG)	≤55	44	8
250	TTFKW250	H	360.8	360.8	800 (D/Am)	300 (C/gG)	≤65	44	8
315	TTFKW315	H	454.7	454.7	1000 (D/Am)	400 (C/gG)	≤65	44	8
400	TTFKW400	H	577.4	577.4	1200 (D/Am)	500 (C/gG)	≤65	44	8
500	TTFKW500	H	721.7	721.7	1600 (D/Am)	800 (C/gG)	≤65	44	8
TTFKZ									
10	TTFKZ10	F	14.4	14.4	32 (D/Am)	12 (C/gG)	≤45	22 - 32	2
12.5	TTFKZ12.5	F	18.0	18.0	40 (D/Am)	12 (C/gG)	≤45	22 - 32	2
16	TTFKZ16	F	23.1	23.1	50 (D/Am)	20 (C/gG)	≤45	22 - 32	2
20	TTFKZ20	F	28.9	28.9	63 (D/Am)	25 (C/gG)	≤45	22 - 32	2
25	TTFKZ25	H	36.1	36.1	80 (D/Am)	30 (C/gG)	≤45	22 - 32	2
31.5	TTFKZ31.5	H	45.5	45.5	100 (D/Am)	40 (C/gG)	≤45	22 - 32	2
40	TTFKZ40	H	57.7	57.7	125 (D/Am)	50 (C/gG)	≤55	22 - 32	2
50	TTFKZ50	H	72.2	72.2	160 (D/Am)	60 (C/gG)	≤55	34 - 44	2
63	TTFKZ63	H	90.9	90.9	200 (D/Am)	80 (C/gG)	≤55	34 - 44	2
80	TTFKZ80	H	115.5	115.5	300 (D/Am)	100 (C/gG)	≤55	34 - 44	2
100	TTFKZ100	H	144.3	144.3	300 (D/Am)	100 (C/gG)	≤55	34 - 44	2
125	TTFKZ125	H	180.4	180.4	400 (D/Am)	160 (C/gG)	≤55	34 - 44	2
160	TTFKZ160	H	230.9	230.9	500 (D/Am)	200 (C/gG)	≤55	34 - 44	2
200	TTFKZ200	H	288.7	288.7	600 (D/Am)	250 (C/gG)	≤55	34 - 44	2
250	TTFKZ250	H	360.8	360.8	800 (D/Am)	300 (C/gG)	≤65	34 - 44	2
315	TTFKZ315	H	454.7	454.7	1000 (D/Am)	400 (C/gG)	≤65	34 - 44	2
400	TTFKZ400	H	577.4	577.4	1200 (D/Am)	500 (C/gG)	≤65	34 - 44	2
500	TTFKZ500	H	721.7	721.7	1600 (D/Am)	800 (C/gG)	≤65	34 - 44	2





TTFK SERIES

Insulation for harmonic three-phase networks · Input 400 V · Output 400 V + N

Measurements

Power kVA	Reference	External dimensions mm			Fastening elements mm			Weight kg
		A	B	C	D	E	Ø	
TTFKX								
10	TTFKX10	420	190	419	162	350	11	88
12.5	TTFKX12.5	480	250	480	144	400	11	96
16	TTFKX16	480	260	480	154	400	11	109
20	TTFKX20	480	270	480	164	400	11	120
25	TTFKX25	480	310	480	204	400	11	159
31.5	TTFKX31.5	670	290	580	150	426	13	182
40	TTFKX40	670	310	580	170	426	13	221
50	TTFKX50	670	330	580	190	426	13	254
63	TTFKX63	785	550	880	460	472	17	347
80	TTFKX80	785	550	880	460	472	17	405
100	TTFKX100	785	550	880	460	472	17	441
125	TTFKX125	785	550	880	460	472	17	544
160	TTFKX160	785	550	880	460	472	17	660
200	TTFKX200	1016	550	1080	460	690	17	758
250	TTFKX250	1070	550	1220	460	690	17	966
315	TTFKX315	1070	550	1220	460	690	17	1176
400	TTFKX400	1300	550	1350	460	800	17	1801
500	TTFKX500	1300	550	1350	460	800	17	2198

Power kVA	Reference	External dimensions mm			Fastening elements mm			Weight kg
		A	B	C	D	E	Ø	
TTFKW								
10	TTFKW10	528	418	644	375	345	12	100
12.5	TTFKW12.5	597	415	710	375	345	12	108
16	TTFKW16	597	415	710	375	345	12	121
20	TTFKW20	597	415	710	375	345	12	132
25	TTFKW25	597	415	710	375	345	12	171
31.5	TTFKW31.5	795	550	970	500	415	12	207
40	TTFKW40	795	550	970	500	415	12	246
50	TTFKW50	795	550	970	500	415	12	279
63	TTFKW63	795	550	970	500	415	12	399
80	TTFKW80	795	550	970	500	415	12	457
100	TTFKW100	970	670	1250	582	470	18	493
125	TTFKW125	970	670	1250	582	470	18	596
160	TTFKW160	970	670	1250	582	470	18	753
200	TTFKW200	1200	760	1555	672	690	18	823
250	TTFKW250	1200	760	1555	672	690	18	1059
315	TTFKW315	1200	760	1555	672	690	18	1269
400	TTFKW400	1530	1000	1880	900	800	20	1921
500	TTFKW500	1530	1000	1880	900	800	20	2318

TTFKX IP00

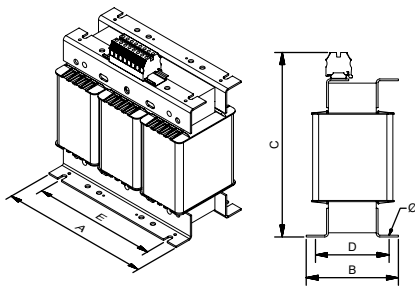

Up to 10 kVA

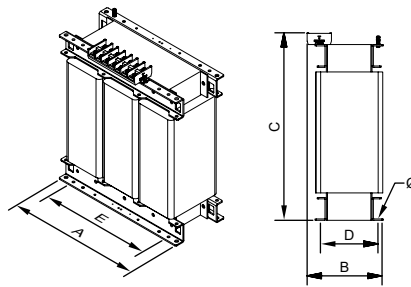

From 12.5 kVA to 125 kVA

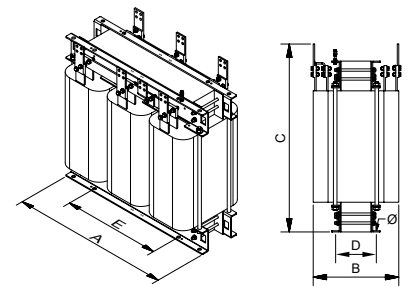

From 160 kVA

TTFKW IP23

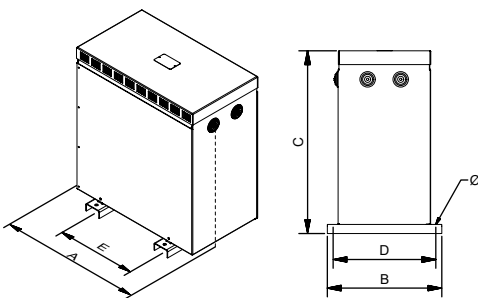

From 10 kVA to 25 kVA

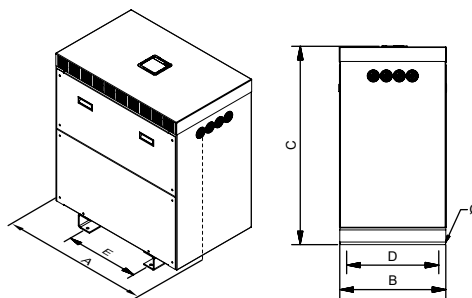

From 31.5 kVA



Sectioned



TTFK SERIES

Insulation for harmonic three-phase networks · Input **400 V** · Output **400 V + N**

Measurements

Power kVA	Reference	External dimensions mm			Fastening elements mm			Weight kg
		A	B	C	D	E	∅	
TTFKZ								
10	TTFKZ10	694	413	764	370	350	11	136
12.5	TTFKZ12.5	694	413	764	370	350	11	149
16	TTFKZ16	694	413	764	370	350	11	160
20	TTFKZ20	694	413	764	370	350	11	199
25	TTFKZ25	694	413	764	370	350	11	247
31.5	TTFKZ31.5	890	560	1148	520	426	13	286
40	TTFKZ40	890	560	1148	520	426	13	319
50	TTFKZ50	890	560	1148	520	426	13	476
63	TTFKZ63	890	560	1148	520	426	13	534
80	TTFKZ80	890	560	1148	520	426	13	570
100	TTFKZ100	972	740	1480	660	470	17	673
125	TTFKZ125	972	740	1480	660	470	17	815
160	TTFKZ160	972	740	1480	660	470	17	926
200	TTFKZ200	1394	870	1762	810	690	17	1152
250	TTFKZ250	1394	870	1762	810	690	17	1362
315	TTFKZ315	1394	870	1762	810	690	17	2001
400	TTFKZ400	1640	1226	1770	1110	800	17	2398
500	TTFKZ500	1640	1226	1770	1110	800	17	2480

TTFKZ IP54 / 65

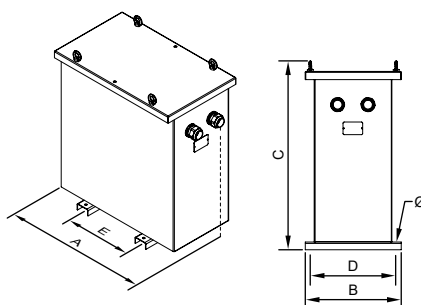



TTFK SERIES

Insulation for harmonic three-phase networks · Input **400 V** · Output **400 V + N**

On-request manufacturing options (please see prices)

Power	From 10 kVA to 500 kVA
Voltage	From 1 V to 12 kV
Windings	Copper or aluminium
Frequency	From 50 Hz to 400 Hz
Connection unit	Yyn0, Dyn11, Dd0, Dy1, Dyn5, Yn1/5/11... (See Technical Appendix T.A.2)
IP rating	IP00, IP20, IP23, IP31, IP42, IP54, IP55 and IP65
IK rating	IK08 and IK10
Room temperature	Up to 60 °C
Locks	Screw, key
Test voltage	Up to 28 kV
Short circuit voltage	From 2% to 9%
Operation	Intermittent, continuous
Cooling	Natural, forced ventilation
Electrostatic shield	Up to three shields
Class	I, II
Altitude	Up to 4000 m
Protections	In both primary and secondary (figure 1)
Temperature sensors	PT100 (figure 2), PTC (figure 3) or bimetallic
Temperature control	Temperature control station (4xPT100) (figure 4), PTC thermal relays (3xPTC / 6xPTC)
Network analyser	(Figure 5)
Anti condensation system	Higrostat
Heating system	Heating elements
External protection	Anti-flash varnish, metallic or stainless steel enclosure
Transportation and hoisting	Wheels (figure 6), lifting points
Paint	C3, C4, C5, different RAL
Feature plate	High generation polymer or stainless steel (figure 7)
Anti vibration system	Silentblock
Adjustment	-10%; -7.5%; -5%; -2.5%; +2.5%; +5%; +7.5%; +10% With bridges (figure 8) or selector (figure 9)
Certified	CE, DNV-GL, BV, UL (insulation) and POLYLUX laboratory
Climate class / environment / fire	Up to C2-E2-F1



Figure 1



Figure 2



Figure 3



Figure 4



Figure 5



Figure 6



Figure 7



Figure 8



Figure 9



TTFK SERIES

Insulation for harmonic three-phase networks · Input 400 V · Output 400 V + N

Feature plate structure

Plastic label up to 31,5 kVA:

POLYLUX		CE		CE declaration of conformity
Power (kVA)	XXX kVA	PRI:	400 V <small>XXX A</small>	Primary voltage
Reference	<small>TTFKXX</small>	SEC:	400 V <small>XXX A</small>	Primary current
Frequency	50 - 60 Hz	F-155°C	IP-XX	Secondary voltage
Insulation transformer symbol		3kV	EN 61558	Secondary current
Serial number	SN: TTFKXXXXXX <small>Made in Spain</small>		9 638 456 958 502	IP rating
				Applicable standard
				EAN bar code
				Test voltage
				Insulators

Stainless steel label from 40 kVA:

POLYLUX		www.polylux.com		Insulators
Performance	XXX kVA	PRI:	400 V <small>XXX A</small>	Test voltage
Short circuit voltage		SEC:	400 V <small>XXX A</small>	Primary voltage
Power (kVA)		50 - 60 Hz	H-180°C	Primary current
Frequency		IEC 60076	IP-XX	Secondary voltage
Insulation transformer symbol		3 kV	ANXX	Secondary current
CE declaration of conformity	CE <small>Made in Spain</small>	Pcc= XXX W	η= XX %	Applicable standard
Losses in short circuit		Po= XXX W	Ucc= X %	Protection rating
Losses when empty		TTFKXXX	XXXX kg	Cooling
		SN:	TTFKXXXXXX	Weight
				Reference
				Serial number



CD SERIES

For office installations



Definition and applications

The CD series are harmonic compensators designed for installation in offices. They provide considerable energy savings, reducing the power demand in the installation and transient current peaks, thus lengthening the service life of the connected appliances.

Manufacturing characteristics

- All the compensators are dipped in anti-flash varnish and then compacted in the furnace. This process increases the insulation grade, reduces noise and provides anti-moisture, waterproofed protection.
- Option of manufacturing C25D-180° for 180° dephasing of non-homopolar harmonics.
- Cable outlet with cable gland
- Hoisting elements included.
- All the compensators are checked automatically one by one and the compliance report is created in accordance with the respective standard.

Technical features - standard model

Standard voltage	400 V
Standard frequency	50-60 Hz
Windings	Class HC-200 °C
Insulators	C10D - Class F - 155 °C
	C20D - Class F - 155 °C ≤ C20D160 - Class H - 180 °C ≥ C20D200
	C22D - Class F - 155 °C ≤ C22D20 - Class H - 180 °C ≥ C22D25
	C25D - Class F - 155 °C ≤ C25D20 - Class H - 180 °C ≥ C25D25
	C30D - Class F - 155 °C ≤ C30D20 - Class H - 180 °C ≥ C30D25
<small>*More information in Technical Appendix (T.A.1)</small>	
Class	I
Altitude	1000 m
Enclosure colour	RAL 7035
IP rating	IP23
IK rating	IK08
Paint class (ISO 12944)	C3
Room temperature	45 °C
Standards	IEC/EN/UNE-EN 60076 I 61000-3-2/4, CE and IEE 519, CE
Test voltage	3 kV (1 min., 50 Hz)
Operation	Continuous
Cooling	ANAN

Connection

Configuration	With just one C25D-0 or C25D-180	Combination of two C25D-0 and C25D-180	Single C30D
Filtering from load	3rd, 9th and 15th	3rd, 5th, 7th, 9th, 15th, 17th and 19th	3rd, 5th, 7th, 9th, 15th, 17th and 19th
Phase current reduction	15%	45%	45%
THDI reduction	45%	85%	85%
THDV reduction	40%	65%	85%

CD SERIES

For office installations

Theoretical data - standard model

Phase current A	Reference	Insulation class	Current A		Protections A		Noise dB	Cable gland	
			Input	Output	Input	Output		ø max. (mm)	Quantity
C10D									
16	C10D16	F	16.0	16.0	16.0	16.0	≤65	14	2
20	C10D20	F	20.0	20.0	20.0	20.0	≤65	14	2
25	C10D25	F	25.0	25.0	25.0	25.0	≤65	14	2
31.5	C10D31.5	F	31.5	31.5	31.5	31.5	≤65	14	2
40	C10D40	F	40.0	40.0	40.0	40.0	≤65	14	2
50	C10D50	F	50.0	50.0	50.0	50.0	≤65	14	2
63	C10D63	F	63.3	63.0	63.0	63.0	≤65	14	2
80	C10D80	F	80.0	80.0	80.0	80.0	≤65	14	2
100	C10D100	F	100.0	100.0	100.0	100.0	≤65	14	2
125	C10D125	F	125.5	125.0	125.0	125.0	≤65	14	2
160	C10D160	F	160.0	160.0	160.0	160.0	≤65	14	2
200	C10D200	F	200.0	200.0	200.0	200.0	≤65	18	2
250	C10D250	F	250.0	250.0	250.0	250.0	≤65	18	2
315	C10D315	F	315.5	315.0	315.0	315.0	≤65	18	2
400	C10D400	F	400.0	400.0	400.0	400.0	≤65	25	4

Neutral current A	Reference	Insulation class	Current A		Protections A		Noise dB	Cable gland	
			Input	Output	Input	Output		ø max. (mm)	Quantity
C20D									
25	C20D25	F	25.5	-	25.5	-	≤65	25	4
31.5	C20D31.5	F	31.5	-	31.5	-	≤65	25	4
40	C20D40	F	40.0	-	40.0	-	≤65	32	4
50	C20D50	F	50.0	-	50.0	-	≤65	32	4
63	C20D63	F	63.3	-	63.3	-	≤65	32	4
80	C20D80	F	80.0	-	80.0	-	≤65	32	4
100	C20D100	F	100.0	-	100.0	-	≤65	32	4
125	C20D125	F	125.5	-	125.5	-	≤65	32	4
160	C20D160	F	160.0	-	160.0	-	≤65	32	4
200	C20D200	H	200.0	-	200.0	-	≤65	32	8
250	C20D250	H	250.0	-	250.0	-	≤65	32	8
315	C20D315	H	315.5	-	315.5	-	≤65	32	8
400	C20D400	H	400.0	-	400.0	-	≤65	44	8
500	C20D500	H	500.0	-	500.0	-	≤65	44	8
630	C20D630	H	630.0	-	630.0	-	≤65	44	8

CD SERIES

For office installations

Theoretical data - standard model

Power kVA	Reference	Insulation class	Current A		Protections A		Noise dB	Cable gland	
			Input	Output	Input	Output		ø max. (mm)	Quantity
C20D									
10	C22D10	F	14.5	14.5	32 (D/aM)	16 (C/gG)	≤45	25	4
12.5	C22D12.5	F	18.1	18.1	32 (D/aM)	16 (C/gG)	≤45	25	4
16	C22D16	F	23.1	23.1	40 (D/aM)	20 (C/gG)	≤45	32	4
20	C22D20	F	28.9	28.9	50 (D/aM)	25 (C/gG)	≤45	32	4
25	C22D25	F	36.1	36.1	63 (D/aM)	32 (C/gG)	≤45	32	4
31.5	C22D31.5	F	45.5	45.5	80 (D/aM)	40 (C/gG)	≤45	32	4
40	C22D40	F	57.8	57.8	100 (D/aM)	50 (C/gG)	≤55	32	4
50	C22D50	F	72.3	72.3	125 (D/aM)	63 (C/gG)	≤55	32	4
63	C22D63	F	91	91	160 (D/aM)	80 (C/gG)	≤55	32	4
80	C22D80	H	116	116	200 (D/aM)	100 (C/gG)	≤55	32	8
100	C22D100	H	145	145	250 (D/aM)	125 (C/gG)	≤55	32	8
125	C22D125	H	181	181	400 (D/aM)	160 (C/gG)	≤55	32	8
160	C22D160	H	231	231	500 (D/aM)	200 (C/gG)	≤55	44	8
C25D-0									
10	C25D10-0	F	14.5	14.5	32 (D/aM)	16 (C/gG)	≤45	32	4
12.5	C25D12.5-0	F	18.1	18.1	32 (D/aM)	16 (C/gG)	≤45	32	4
16	C25D16-0	F	23.1	23.1	40 (D/aM)	20 (C/gG)	≤45	32	4
20	C25D20-0	F	28.9	28.9	50 (D/aM)	25 (C/gG)	≤45	32	4
25	C25D25-0	H	36.1	36.1	63 (D/aM)	32 (C/gG)	≤45	32	8
31.5	C25D31.5-0	H	45.5	45.5	80 (D/aM)	40 (C/gG)	≤45	32	8
40	C25D40-0	H	57.8	57.8	100 (D/aM)	50 (C/gG)	≤55	32	8
50	C25D50-0	H	72.3	72.3	125 (D/aM)	63 (C/gG)	≤55	44	8
63	C25D63-0	H	91	91	160 (D/aM)	80 (C/gG)	≤55	44	8
80	C25D80-0	H	116	116	200 (D/aM)	100 (C/gG)	≤55	44	8
100	C25D100-0	H	145	145	250 (D/aM)	125 (C/gG)	≤55	44	8
125	C25D125-0	H	181	181	400 (D/aM)	160 (C/gG)	≤55	44	8
160	C25D160-0	H	231	231	500 (D/aM)	200 (C/gG)	≤55	44	8
C25D-180									
10	C25D10-180	F	14.5	14.5	32 (D/aM)	16 (C/gG)	≤45	32	4
12.5	C25D12.5-180	F	18.1	18.1	32 (D/aM)	16 (C/gG)	≤45	32	4
16	C25D16-180	F	23.1	23.1	40 (D/aM)	20 (C/gG)	≤45	32	4
20	C25D20-180	F	28.9	28.9	50 (D/aM)	25 (C/gG)	≤45	32	4
25	C25D25-180	H	36.1	36.1	63 (D/aM)	32 (C/gG)	≤45	32	8
31.5	C25D31.5-180	H	45.5	45.5	80 (D/aM)	40 (C/gG)	≤45	32	8
40	C25D40-180	H	57.8	57.8	100 (D/aM)	50 (C/gG)	≤55	32	8
50	C25D50-180	H	72.3	72.3	125 (D/aM)	63 (C/gG)	≤55	44	8
63	C25D63-180	H	91	91	160 (D/aM)	80 (C/gG)	≤55	44	8
80	C25D80-180	H	116	116	200 (D/aM)	100 (C/gG)	≤55	44	8
100	C25D100-180	H	145	145	250 (D/aM)	125 (C/gG)	≤55	44	8
125	C25D125-180	H	181	181	400 (D/aM)	160 (C/gG)	≤55	44	8
160	C25D160-180	H	231	231	500 (D/aM)	200 (C/gG)	≤55	44	8
C30D									
10	C30D10	F	14.5	14.5	32 (D/aM)	16 (C/gG)	≤45	32	4
12.5	C30D12.5	F	18.1	18.1	32 (D/aM)	16 (C/gG)	≤45	32	4
16	C30D16	F	23.1	23.1	40 (D/aM)	20 (C/gG)	≤45	32	4
20	C30D20	F	28.9	28.9	50 (D/aM)	25 (C/gG)	≤45	32	4
25	C30D25	H	36.1	36.1	63 (D/aM)	32 (C/gG)	≤45	32	8
31.5	C30D31.5	H	45.5	45.5	80 (D/aM)	40 (C/gG)	≤45	32	8
40	C30D40	H	57.8	57.8	100 (D/aM)	50 (C/gG)	≤55	44	8
50	C30D50	H	72.3	72.3	125 (D/aM)	63 (C/gG)	≤55	44	8
63	C30D63	H	91	91	160 (D/aM)	80 (C/gG)	≤55	44	8
80	C30D80	H	116	116	200 (D/aM)	100 (C/gG)	≤55	44	8
100	C30D100	H	145	145	250 (D/aM)	125 (C/gG)	≤55	44	8
125	C30D125	H	181	181	400 (D/aM)	160 (C/gG)	≤55	44	8
160	C30D160	H	231	231	500 (D/aM)	200 (C/gG)	≤55	44	8

CD SERIES

For office installations

Measurements

Phase current A	Reference	External dimensions mm			Fastening elements mm			Weight kg
		A	B	C	D	E	Ø	
C10D								
16	C10D16	194	175	220	165	100	6	5.2
20	C10D20	240	190	250	180	150	6	7.7
25	C10D25	240	190	250	180	150	6	8.6
31.5	C10D31.5	240	190	250	180	150	6	10.4
40	C10D40	240	190	250	180	150	6	10.6
50	C10D50	315	230	315	205	200	6	13.3
63	C10D63	315	230	315	205	200	6	13.7
80	C10D80	315	230	315	205	200	6	14.4
100	C10D100	315	230	315	205	200	6	17.5
125	C10D125	315	230	315	205	200	6	18.2
160	C10D160	315	230	315	205	200	6	21.5
200	C10D200	385	260	384	245	250	6	24.9
250	C10D250	385	260	384	245	250	6	28.7
315	C10D315	385	260	384	245	250	6	38
400	C10D400	458	340	500	300	300	12	44.9

Neutral current A	Reference	External dimensions mm			Fastening elements mm			Weight kg
		A	B	C	D	E	Ø	
C20D								
25	C20D25	458	340	500	300	300	12	50
31.5	C20D31.5	458	340	500	300	300	12	62
40	C20D40	528	418	644	375	345	12	80
50	C20D50	528	418	644	375	345	12	98
63	C20D63	597	415	710	375	345	12	99
80	C20D80	597	415	710	375	345	12	102
100	C20D100	597	415	710	375	345	12	109
125	C20D125	597	415	710	375	345	12	129
160	C20D160	597	415	710	375	345	12	152
200	C20D200	795	550	970	500	415	12	204
250	C20D250	795	550	970	500	415	12	235
315	C20D315	795	550	970	500	415	12	276
400	C20D400	795	550	970	500	415	12	365
500	C20D500	795	550	970	500	415	12	416
630	C20D630	970	670	1250	582	470	18	467

Power kVA	Reference	External dimensions mm			Fastening elements mm			Weight kg
		A	B	C	D	E	Ø	
C22D								
10	C22D10	528	418	644	375	345	12	97
12.5	C22D12.5	597	415	710	375	345	12	107
16	C22D16	597	415	710	375	345	12	130
20	C22D20	597	415	710	375	345	12	150
25	C22D25	597	415	710	375	345	12	201
31.5	C22D31.5	795	550	970	500	415	12	217
40	C22D40	795	550	970	500	415	12	248
50	C22D50	795	550	970	500	415	12	376
63	C22D63	795	550	970	500	415	12	390
80	C22D80	795	550	970	500	415	12	457
100	C22D100	970	670	1250	582	470	18	518
125	C22D125	970	670	1250	582	470	18	622
160	C22D160	1200	760	1555	672	690	18	751

Power kVA	Reference		External dimensions mm			Fastening elements mm			Weight kg
			A	B	C	D	E	Ø	
C25D									
10	C25D10-0	C25D10-180	597	415	710	375	345	12	106
12.5	C25D12.5-0	C25D12.5-180	597	415	710	375	345	12	126
16	C25D16-0	C25D16-180	597	415	710	375	345	12	149
20	C25D20-0	C25D20-180	597	415	710	375	345	12	175
25	C25D25-0	C25D25-180	795	550	970	500	415	12	216
31.5	C25D31.5-0	C25D31.5-180	795	550	970	500	415	12	254
40	C25D40-0	C25D40-180	795	550	970	500	415	12	292
50	C25D50-0	C25D50-180	795	550	970	500	415	12	418
63	C25D63-0	C25D63-180	795	550	970	500	415	12	526
80	C25D80-0	C25D80-180	970	670	1250	582	470	18	578
100	C25D100-0	C25D100-180	970	670	1250	582	470	18	623
125	C25D125-0	C25D125-180	1200	760	1555	672	690	18	750
160	C25D160-0	C25D160-180	1200	760	1555	672	690	18	834

Power kVA	Reference	External dimensions mm			Fastening elements mm			Weight kg
		A	B	C	D	E	Ø	
C30D								
10	C30D10	597	415	710	375	345	12	110
12.5	C30D12.5	597	415	710	375	345	12	131
16	C30D16	597	415	710	375	345	12	153
20	C30D20	597	415	710	375	345	12	175
25	C30D25	795	550	970	500	415	12	222
31.5	C30D31.5	795	550	970	500	415	12	279
40	C30D40	795	550	970	500	415	12	383
50	C30D50	795	550	970	500	415	12	390
63	C30D63	795	550	970	500	415	12	449
80	C30D80	970	670	1250	582	470	18	534
100	C30D100	970	670	1250	582	470	18	592
125	C30D125	1200	760	1555	672	690	18	758
160	C30D160	1200	760	1555	672	690	18	854

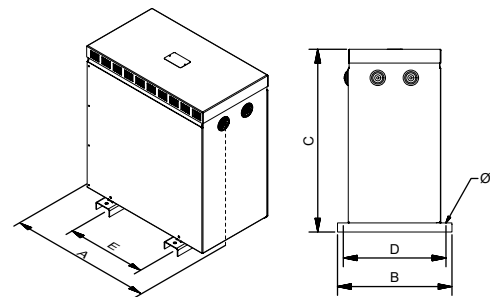

C10D, up to C20D160 and up to 20 kVA for C22D / C25D / C30D

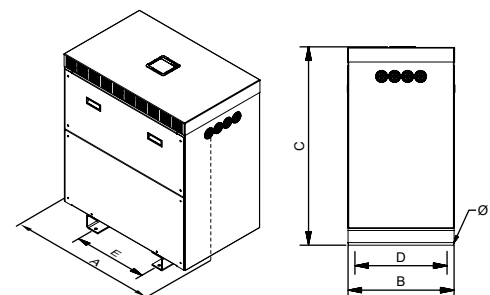

From C20D200 and from 25 kVA for C22D / C25D / C30D



CD SERIES

For office installations

On-request manufacturing options (please see prices)

Power	From 10 kVA to 160 kVA
Windings	Copper or aluminium
Frequency	From 50 Hz to 400 Hz
IP rating	IP20, IP23, IP31, IP42, IP54, IP55 and IP65
IK rating	IK08 and IK10
Room temperature	Up to 60 °C
Locks	Screw, key
Operation	Intermittent, continuous
Cooling	Natural, forced ventilation
Electrostatic shield	Up to three shields
Class	I, II
Altitude	Up to 4000 m
Protections	In both primary and secondary (figure 1)
Temperature sensors	PT100 (figure 2), PTC (figure 3) or bimetallic
Temperature control	Temperature control station (4xPT100) (figure 4), PTC thermal relays (3xPTC / 6xPTC)
Network analyser	(Figure 5)
Anti condensation system	Higrostat
Heating system	Heating elements
External protection	Metallic or stainless steel enclosure
Transportation and hoisting	Wheels (figure 6), lifting points
Paint	C3, C4, C5, different RAL
Feature plate	High generation polymer or stainless steel (figure 7)
Anti vibration system	Silentblock
Adjustment	-10%; -7.5%; -5%; -2.5%; +2.5%; +5%; +7.5%; +10% With bridges (figure 8) or selector (figure 9)
Certified	CE, DNV-GL, BV, UL (insulation) and POLYLUX laboratory
Climate class / environment / fire	Up to C2-E2-F1



Figure 1



Figure 2



Figure 3



Figure 4



Figure 5



Figure 6



Figure 7



Figure 8



Figure 9

CD SERIES

For office installations

Feature plate structure

Plastic cable for C10D, up to C20D160

- For C10D, up to C20D160:

POLYLUX®		CE		CE declaration of conformity
Current	XXXA	400 V		Voltage
Reference	CXXDXX	L = 3 x XXX mH		Autoinduction coefficient
Frequency	50 - 60 Hz	F-155°C	IP-XX	IP rating
		3kV	EN 60076	Applicable standard
Serial number	SN: CXXDXXXXXX			EAN bar code
	Made in Spain	9 638 456 958 502		Test voltage Insulators

- Up to 20 kVA for C22D / C25D / C30D:

POLYLUX®		CE		CE declaration of conformity
Power (kVA)	XXX kVA	PRI: 400 V		Primary voltage
Reference	CXXDXX	XXX A		Primary current
Frequency	50 - 60 Hz	SEC: 400 V		Secondary voltage
		XXX A		Secondary current
		F-155°C	IP-XX	IP rating
Serial number	SN: CXXDXXXXXX	3kV	EN 61558	Applicable standard
	Made in Spain			EAN bar code
		9 638 456 958 602		Test voltage Insulators

CD SERIES

For office installations

Feature plate structure

Stainless steel label:

- From C20D200:

POLYLUX®		www.polylux.com	
Performance	Short circuit voltage	PRI:	Vn=400 V
		SEC:	In=400 A
Power (kVA)	Frequency	XXX A	
CE declaration of conformity	Losses in short circuit	50 - 60 Hz	H-180°C
		IEC 60076	3 kV
Losses when empty	Weight	Pcc=XXX W	η=XX %
		ANXX	IP-XX
		Po=XXX W	Ucc=X %
		XXXX kg	
		CXXDXXX	
		SN:	
		CXXDXXXXXX	

- From 25 kVA for C22D / C25D / C30D:

POLYLUX®		www.polylux.com	
Performance	Short circuit voltage	PRI:	400 V
		SEC:	400 V
Power (kVA)	Frequency	XXX kVA	
CE declaration of conformity	Losses in short circuit	50 - 60 Hz	H-180°C
		IEC 60076	3 kV
Losses when empty	Weight	Pcc=XXX W	η=XX %
		ANXX	IP-XX
		Po=XXX W	Ucc=X %
		XXXX kg	
		CXXDXXX	
		SN:	
		CXXDXXXXXX	

CF SERIES

For industrial installations · For non-homopolar harmonics



Definition and applications

The CF series are non-homopolar harmonic compensators designed for industrial installations.

The C10F compensators are specially designed for heavy industry where the presence of homopolar harmonics is usually negligible and problems arise due to harmonics of the 5th, 7th, 17th, 19th orders and others.

Along with line inductances, they are successful in reducing phase currents of up to 35% and a reduction in current distortion and voltage of up to 85%.

Manufacturing characteristics

- All the compensators are dipped in anti-flash varnish and then compacted in the furnace. This process increases the insulation grade, reduces noise and provides anti-moisture, waterproofed protection.
- Cable outlet with cable gland
- Hoisting elements included.
- All the compensators are checked automatically one by one and the compliance report is created in accordance with the respective standard.

Technical features - standard model

Standard voltage	400 V
Standard frequency	50-60 Hz
Windings	Class HC-200 °C
Insulators	C10F - Class F - 155 °C ≤ C10F31.5 - Class H - 180 °C ≥ C10F40 C20F - Class F - 155 °C ≤ C20F25 - Class H - 180 °C ≥ C20F31.5 <small>*More information in Technical Appendix (T.A.1)</small>
Class	I
Altitude	1000 m
Enclosure colour	RAL 7035
IP rating	IP23
IK rating	IK08
Paint class (ISO 12944)	C3
Room temperature	45 °C
Standards	IEC/EN/UNE-EN 60076 I 61000-3-2/4, CE and IEE 519, CE
Test voltage	3 kV (1 min., 50 Hz)
Operation	Continuous
Cooling	ANAN

CF SERIES

For industrial installations · For non-homopolar harmonics

Theoretical data - standard model

Power kVA	Reference	Insulation class	Current A		Protections A		Noise dB	Cable gland	
			Input	Output	Input	Output		ø max. (mm)	Quantity
C10F									
10	C10F10	F	14.5	14.5	32 (D/aM)	16 (C/gG)	≤45	32	4
12.5	C10F12.5	F	18.1	18.1	32 (D/aM)	16 (C/gG)	≤45	32	4
16	C10F16	F	23.1	23.1	40 (D/aM)	20 (C/gG)	≤45	32	4
20	C10F20	F	28.9	28.9	50 (D/aM)	25 (C/gG)	≤45	32	4
25	C10F25	F	36.1	36.1	63 (D/aM)	32 (C/gG)	≤45	32	4
31.5	C10F31.5	F	45.5	45.5	80 (D/aM)	40 (C/gG)	≤45	32	4
40	C10F40	H	57.8	57.8	100 (D/aM)	50 (C/gG)	≤55	32	8
50	C10F50	H	72.3	72.3	125 (D/aM)	63 (C/gG)	≤55	32	8
63	C10F63	H	91	91	160 (D/aM)	80 (C/gG)	≤55	32	8
80	C10F80	H	116	116	200 (D/aM)	100 (C/gG)	≤55	32	8
100	C10F100	H	145	145	250 (D/aM)	125 (C/gG)	≤55	44	8
125	C10F125	H	181	181	400 (D/aM)	160 (C/gG)	≤55	44	8
160	C10F160	H	231	231	500 (D/aM)	200 (C/gG)	≤55	44	8
200	C10F200	H	289	289	630 (D/aM)	250 (C/gG)	≤55	44	8
C20F									
10	C20F10	F	14.5	14.5	32 (D/aM)	16 (C/gG)	≤45	32	4
12.5	C20F12.5	F	18.1	18.1	32 (D/aM)	16 (C/gG)	≤45	32	4
16	C20F16	F	23.1	23.1	40 (D/aM)	20 (C/gG)	≤45	32	4
20	C20F20	F	28.9	28.9	50 (D/aM)	25 (C/gG)	≤45	32	4
25	C20F25	F	36.1	36.1	63 (D/aM)	32 (C/gG)	≤45	32	4
31.5	C20F31.5	H	45.5	45.5	80 (D/aM)	40 (C/gG)	≤45	32	4
40	C20F40	H	57.8	57.8	100 (D/aM)	50 (C/gG)	≤55	32	8
50	C20F50	H	72.3	72.3	125 (D/aM)	63 (C/gG)	≤55	32	8
63	C20F63	H	91	91	160 (D/aM)	80 (C/gG)	≤55	32	8
80	C20F80	H	116	116	200 (D/aM)	100 (C/gG)	≤55	32	8
100	C20F100	H	145	145	250 (D/aM)	125 (C/gG)	≤55	44	8
125	C20F125	H	181	181	400 (D/aM)	160 (C/gG)	≤55	44	8
160	C20F160	H	231	231	500 (D/aM)	200 (C/gG)	≤55	44	8
200	C20F200	H	289	289	630 (D/aM)	250 (C/gG)	≤55	44	8
250	C20F250	H	361	361	800 (D/aM)	300 (C/gG)	≤55	44	8

CF SERIES

For industrial installations · For non-homopolar harmonics

Measurements

Power kVA	Reference	External dimensions mm			Fastening elements mm			Weight kg
		A	B	C	D	E	∅	
C10F								
10	C10F10	528	418	644	375	345	12	80
12.5	C10F12.5	528	418	644	375	345	12	96
16	C10F16	597	415	710	375	345	12	101
20	C10F20	597	415	710	375	345	12	109
25	C10F25	597	415	710	375	345	12	128
31.5	C10F31.5	597	415	710	375	345	12	153
40	C10F40	597	415	710	375	345	12	197
50	C10F50	795	550	970	500	415	12	213
63	C10F63	795	550	970	500	415	12	248
80	C10F80	795	550	970	500	415	12	290
100	C10F100	795	550	970	500	415	12	398
125	C10F125	795	550	970	500	415	12	448
160	C10F160	970	670	1250	582	470	18	517
200	C10F200	970	670	1250	582	470	18	625

Power kVA	Reference	External dimensions mm			Fastening elements mm			Weight kg
		A	B	C	D	E	∅	
C20F								
10	C20F10	597	415	710	375	345	12	103
12.5	C20F12.5	597	415	710	375	345	12	109
16	C20F16	597	415	710	375	345	12	131
20	C20F20	597	415	710	375	345	12	153
25	C20F25	597	415	710	375	345	12	173
31.5	C20F31.5	795	550	970	500	415	12	213
40	C20F40	795	550	970	500	415	12	253
50	C20F50	795	550	970	500	415	12	289
63	C20F63	795	550	970	500	415	12	405
80	C20F80	795	550	970	500	415	12	449
100	C20F100	970	670	1250	582	470	18	497
125	C20F125	970	670	1250	582	470	18	607
160	C20F160	1200	760	1555	672	690	18	758
200	C20F200	1200	760	1555	672	690	18	830
250	C20F250	1200	760	1555	672	690	18	1136

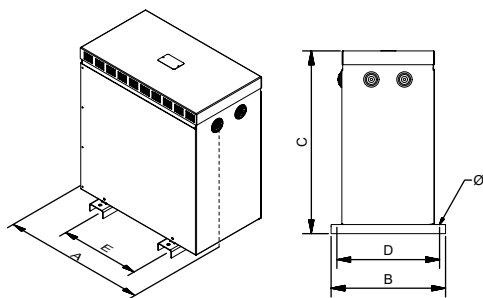

Up to C10F31.5 and up to C20F25

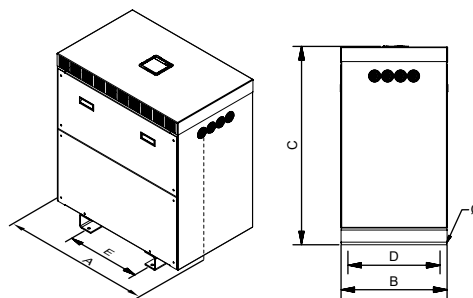

From C10F40 and from C20F31.5



CF SERIES

For industrial installations · For non-homopolar harmonics

On-request manufacturing options (please see prices)

Power	From 10 kVA to 250 kVA
Windings	Copper or aluminium
Frequency	From 50 Hz to 400 Hz
IP rating	IP20, IP23, IP31, IP42, IP54, IP55 and IP65
IK rating	IK08 and IK10
Room temperature	Up to 60 °C
Locks	Screw, key
Operation	Intermittent, continuous
Cooling	Natural, forced ventilation
Electrostatic shield	Up to three shields
Class	I, II
Altitude	Up to 4000 m
Protections	In both primary and secondary (figure 1)
Temperature sensors	PT100 (figure 2), PTC (figure 3) or bimetallic
Temperature control	Temperature control station (4xPT100) (figure 4), PTC thermal relays (3xPTC / 6xPTC)
Network analyser	(Figure 5)
Anti condensation system	Higrostat
Heating system	Heating elements
External protection	Metallic or stainless steel enclosure
Transportation and hoisting	Wheels (figure 6), lifting points
Paint	C3, C4, C5, different RAL
Feature plate	High generation polymer or stainless steel (figure 7)
Anti vibration system	Silentblock
Adjustment	-10%; -7.5%; -5%; -2.5%; +2.5%; +5%; +7.5%; +10% With bridges (figure 8) or selector (figure 9)
Certified	CE, DNV-GL, BV, UL (insulation) and POLYLUX laboratory
Climate class / environment / fire	Up to C2-E2-F1



Figure 1



Figure 2



Figure 3



Figure 4



Figure 5



Figure 6



Figure 7



Figure 8



Figure 9

CF SERIES

For industrial installations · For non-homopolar harmonics

Feature plate structure

Plastic label up to C10F31.5 and up to C20F25

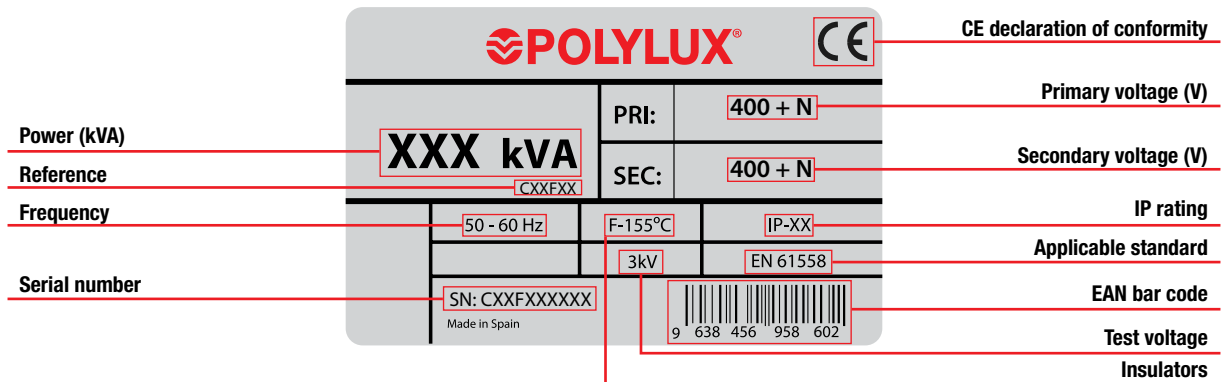

Stainless steel label from C10F40 and from C20F31.5:

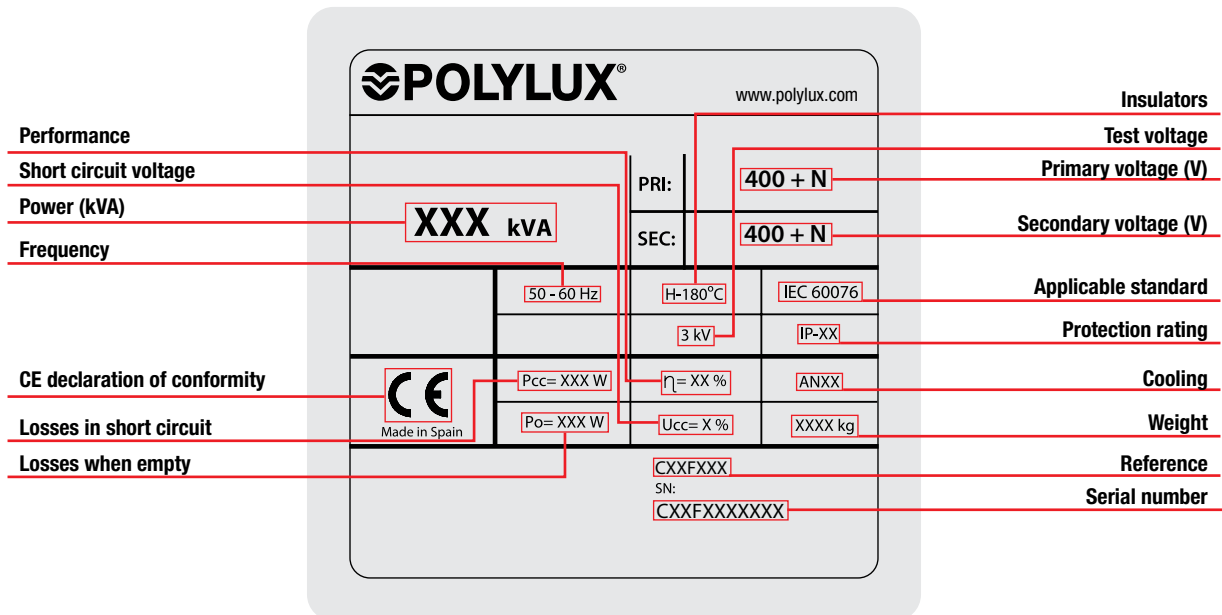

Office installation solutions

Solution 1

Filtering of 3°, 9° and 15° harmonics.
C10D + C20D compensator

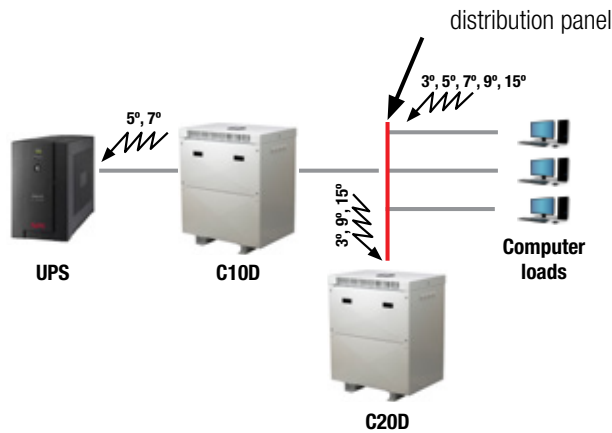

The 20D Compensator has a very good cost-filter ratio. It reduces homopolar harmonics (3rd, 9th, 15th) thus eliminating the main problem in office installations which is overload in the neutral conductor and a high neutral-ground voltage.

The C20D Compensators must be installed together with the C10D Impedance Adapter to obtain the best filtering.

Filtering obtained:

Reduction of neutral current and neutral-ground voltage up to	75%
Reduction of phase current up to	15%
Reduction of voltage distortion and current up to	45%
Power factor obtained up to	0.80

Solution 2

Filtering of harmonics of the 3°, 5°, 7°, 9°, 15°, 17° and 19° orders
C10D + C20D and C10D + C22D Compensator

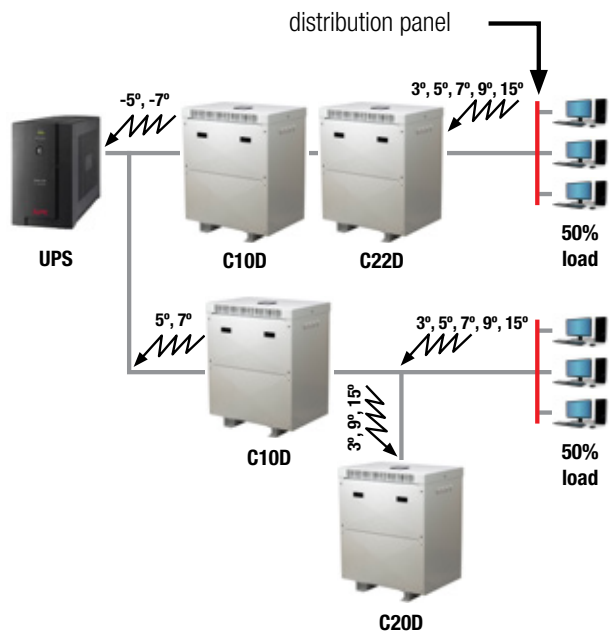

The C22D Compensator provides high filtering of 3rd, 5th, 7th, 9th, 15th, 17th and 19th harmonics. This solves all the harmonics problems in the installation. It is used in combination with the C20D + C10D model. Each one supplies 50% of the load to be filtered.

The C20D and C22D Compensators must be installed with the C10D Impedance Adapters for optimum filtering.

Filtering obtained:

Reduction of neutral current and neutral-ground voltage up to	80 %
Reduction of phase current up to	40 %
Reduction of voltage distortion and current up to	75 %
Power factor obtained up to	0.95

Solution 3

Filtering of harmonics with galvanic isolation of 3°, 9° and 15°
C25D Compensator

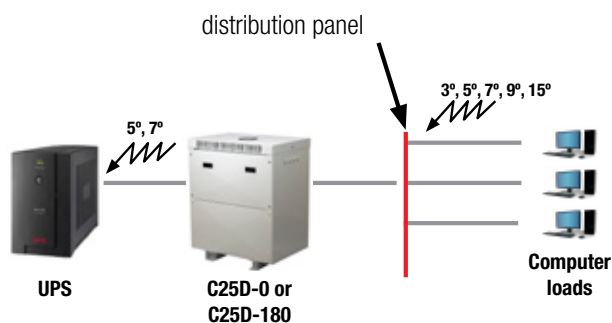

The C25D Compensator completely eliminates all homopolar harmonics (3rd, 9th, 15th), preventing surge current in neutral and high neutral-ground voltages produced by harmonics.

As it is a Compensator with galvanic isolation, it is the perfect solution in cases of high third harmonic voltages. It also has the following advantages: reduction of electromagnetic perturbations from the network, offers the possibility of changing the voltage between input and output and permits the use of independent ground circuits as the neutral is isolated from the network.

Filtering obtained:

Reduction of neutral current and neutral-ground voltage up to	90%
Reduction of phase current up to	15%
Reduction of current distortion up to	45%
Reduction of voltage distortion up to	40%
Power factor obtained up to	0.80

Office installation solutions

Solution 4

Filtering of harmonics with galvanic separation 3°, 5°, 7°, 9°, 15°, 17° and 19°
C25D Compensator

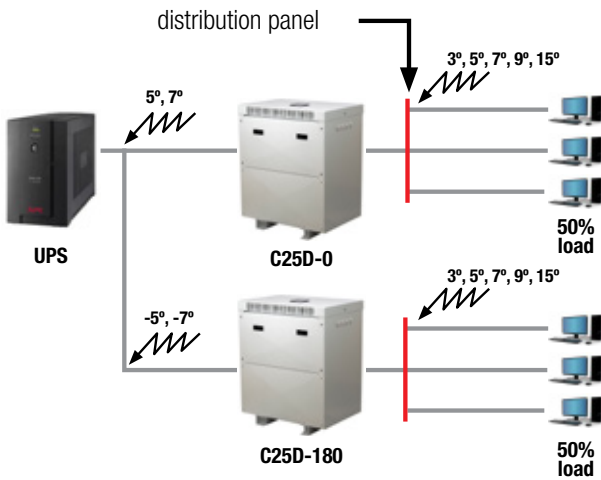

The C25D Compensator has two variants, depending on the dephase of the 5th and 7th harmonics. They are 0° and 180°. Combining their use, it is possible to eliminate 3rd, 5th, 7th, 9th, 15th, 17th and 19th harmonics.

Filtering obtained by combining the 0° and 180° variants:

Reduction of neutral current and neutral-ground voltage up to	90%
Reduction of phase current up to	45%
Reduction of voltage distortion and current up to	85%
Power factor obtained up to	0.96

Solution 5

Filtering of harmonics with galvanic separation 3°, 5°, 7°, 9°, 15°, 17° and 19°
C30D Compensator

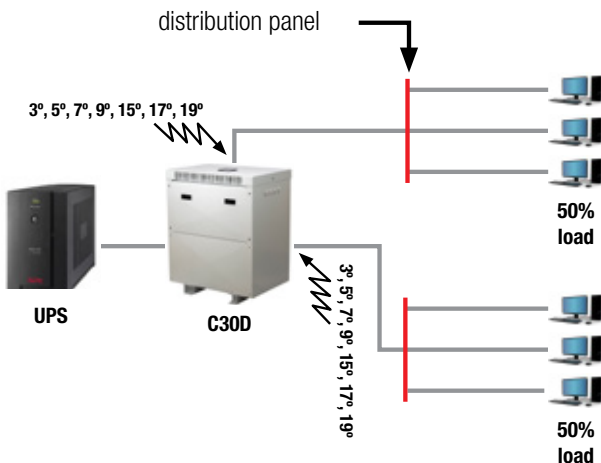

The C30D Compensator obtains the highest filtering in office installations. It eliminates 3rd, 5th, 7th, 9th, 15th, 17th and 19th harmonics and has additional advantages such as reducing electromagnetic perturbations coming from the network, permitting changes in voltage between input and output and making it possible to use independent ground circuits.

Filtering obtained:

Reduction of neutral current and neutral-ground voltage up to	90%
Reduction of phase current up to	45%
Reduction of voltage distortion and current up to	85%
Power factor obtained up to	0.96

Solutions for industrial installations

Solution 1

Optimum filtering of 3°, 5°, 7°, 9°, 15°, 17° and 19° harmonics.

C10F Compensator

The C10F Compensator is used in cases where very high filtering is required. Its operation is based on installing a C10F unit supplying 50% of the load and the other 50% is direct.

To ensure correct filtering, it is advisable to install it together with RTL or RTLX line inductances, particularly with converters with powers over 5 kVA.

Filtering obtained:

	C10F	C10F + RTL
Reduction of phase current up to	20%	35%
Reduction of voltage distortion and current up to	60%	85%
Power factor obtained up to	0.95	0.98

- (1) Transformer
- (2) Rejection inductance
- (3) Capacitator battery
- (4) Compensator
- (5) RTL or RTLX line inductance
- (6) Frequency variator
- (7) Motor
- (8) PLC
- (9) Computer

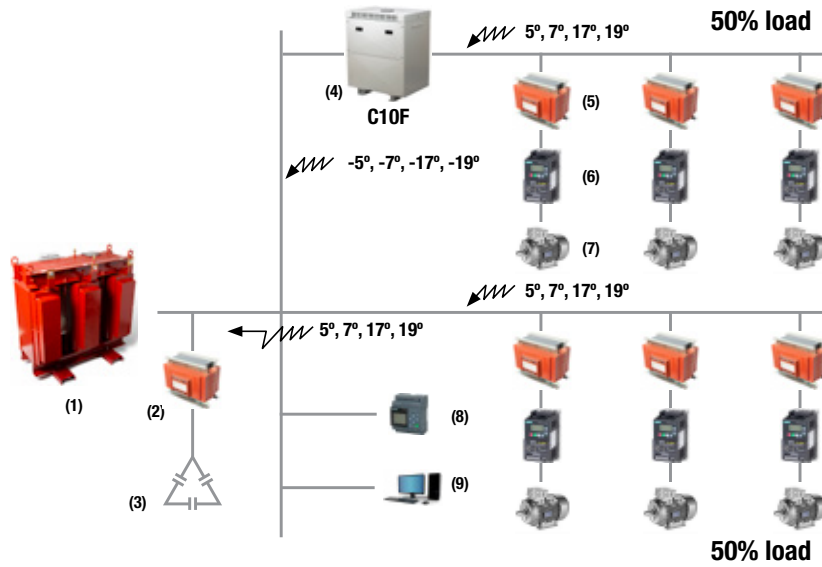

Solution 2

High filtering of 5°, 7°, 17° and 19° harmonics and galvanic isolation of load.

C20F Compensator

The C20F Compensator attains the highest level of protection in industrial installations. It obtains a high filtering of harmonics as well as the galvanic isolation of the load. It has two outputs, each one supplying 50% of the load.

To ensure correct filtering, it is advisable to install it together with RTL or RTLX line inductances, particularly with converters with powers over 5 kVA.

Filtering obtained:

	C20F	C20F + RTL
Reduction of phase current up to	20%	35%
Reduction of voltage distortion and current up to	60%	85%
Power factor obtained up to	0.95	0.98

- (1) Transformer
- (2) Rejection inductance
- (3) Capacitator battery
- (4) Compensator
- (5) RTL or RTLX line inductance
- (6) Frequency variator
- (7) Motor
- (8) PLC
- (9) Computer

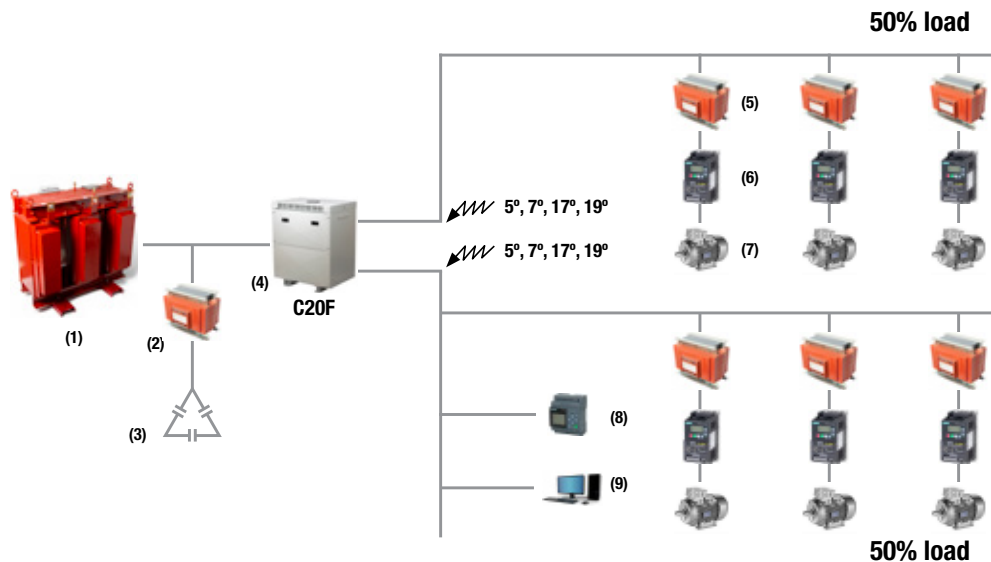

QR SERIES

Encapsulated for harmonic filtering in single-phase lines · Network 220 V - 260 V



NEW head design

- Increased wiring insulation.
- Clearer features.
- Easier connection.
- More uniform, compact and robust design.

Definition and applications

The QR series are inductances for harmonic filtering in low power single-phase installations.

Specific applications:

- Reduction of current harmonics generated by electronic equipment, reducing current consumption and improving the power factor.
- Reduction of the crest factor of the current waveform, lengthening the service life of the equipment.
- Attenuation of micro power cuts produced by the converter that cause the malfunction of computers, automatons and other susceptible equipment.

Manufacturing characteristics

All the versions have the following features in common:

- Encapsulated in flame retardant resin.
- Connection terminals made of copper, welded and inserted in blocks to prevent hazards caused by expansion that may lead to poor connection.
- Option of mounting on **DIN rail up to 16 A**, rest with screws.
- IP20 enclosure, V-0 flame-retardant polymer box that complies with UL94.
- **All the parts of these inductances are live and encapsulated in resin, and are thus specially indicated for operating in damp, saline or corrosive environments.**
- **They have greater resistance to current surges and transient harmonics.**
- **Greater mechanical resistance to vibrations and undesirable movements.**
- Safety Class I, convertible to Class II.
- All the inductances are checked automatically one by one and the compliance report is created based on the respective standard.

Technical features - standard model

Current	2.5 A to 31.5 A
Insulators	Class B - 130 °C
Winding	Class HC - 200 °C
Room temperature	45 °C
Frequency	50-60 Hz
Noise	≤ 40 dB
Protection rating	IP20
Cooling	AN
Mounting	Mounting on DIN 46277/3 rail (up to 16 A) or with screws
Standards	UNE-EN 60289, CE
Protection	Convertible from Class I to Class II
Operation	Continuous
Test voltage	3 kV (1 min., 50 Hz) between coil and ground

Electrical diagram

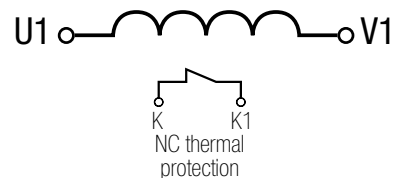

QR SERIES

Encapsulated for harmonic filtering in single-phase lines · Network **220 V - 260 V**

Terminal types

Terminal blocks	External mm				Maximum tightening torque N·m	Primary Current A		Secondary Current A	
	A	B	C	Ø		From	To	From	To
	Terminal M3	8	11	9		M3	0.5	2.5	5
Terminal M4	10	13.5	12	M4	1.1	6.3	31.5	6.3	16
Terminal M5	15	18.5	14	M5	2.5	-	-	20	31.5

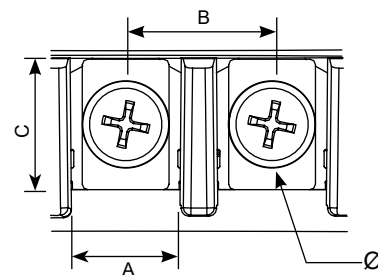

Theoretical data - standard model

Current A	Reference	L mH	Motor power	
			kVA	HP
2.5	QR2.5	8.785	0.23	0.31
4	QR4	5.491	0.37	0.5
5	QR5	4.393	0.46	0.6
6.3	QR6.3	3.486	0.55	0.75
8	QR8	2.745	0.75	1
10	QR10	2.196	1.1	1.5
12.5	QR12.5	1.757	1.5	2
16	QR16	1.373	1.85	2.5
20	QR20	1.098	2.2	3
25	QR25	0.879	3	4
31.5	QR31.5	0.697	4	5.5

Measurements

Current A	Ref.	External dimensions mm			Fastening elements mm			Weight kg
		A	B	C	D	E	Ø	
2.5	QR2.5	84	101	98	88	55	5	0.77
4	QR4	84	101	98	88	55	5	0.77
5	QR5	84	101	98	88	55	5	0.94
6.3	QR6.3	106	123	118	110	74	5	1.4
8	QR8	106	123	118	110	74	5	1.4
10	QR10	106	123	118	110	74	5	1.4
12.5	QR12.5	106	123	118	110	74	5	1.4
16	QR16	106	123	118	110	74	5	1.9
20	QR20	118	138	131	121	88	6	3.2
25	QR25	118	138	131	121	88	6	3.2
31.5	QR31.5	136	162	156	145	104	6	3.2

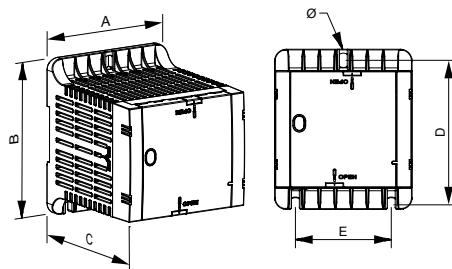

QR SERIES

Encapsulated for harmonic filtering in single-phase lines · Network 220 V - 260 V

Feature plate structure

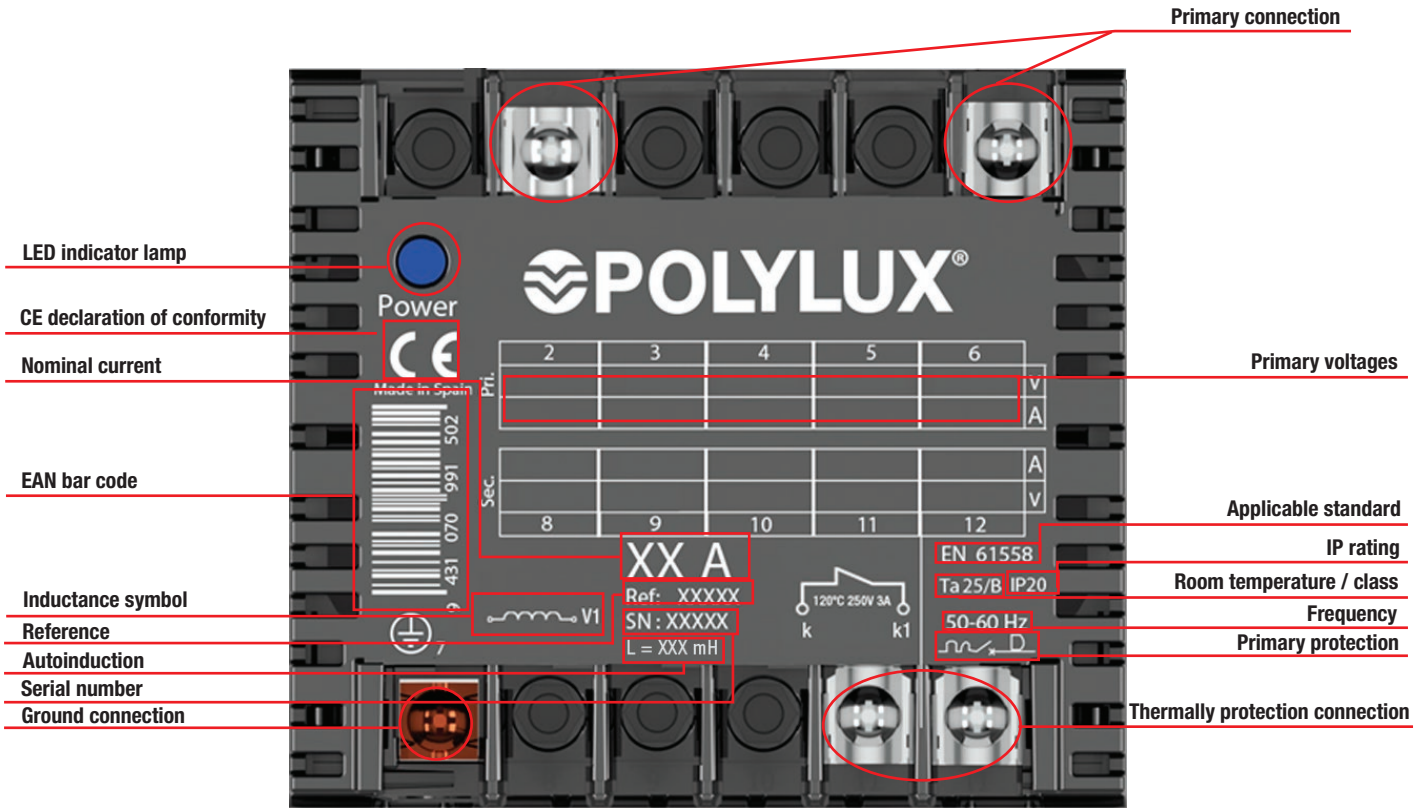



R SERIES

Encapsulated for harmonic filtering in single-phase lines · Network 220 V - 260 V



Technical features - standard model

Current	2.5 A to 100 A
Insulators	Class B - 130 °C
Winding	Class HC - 200 °C
Room temperature	45 °C
Frequency	50-60 Hz
Noise	≤ 45 dB
Protection rating	IP20
Cooling	AN
Mounting	Mounting on DIN 46277/3 rail (up to 16 A) or with screws
Standards	UNE-EN 60289, CE
Protection	Class I
Operation	Continuous
Test voltage	3 kV (1 min., 50 Hz) between coil and ground

Definition and applications

The R series are inductances for harmonic filtering in low power single-phase installations.

Specific applications:

- Reduction of current harmonics generated by electronic equipment, reducing current consumption and improving the power factor.
- Reduction of the crest factor of the current waveform, lengthening the service life of the equipment.
- Attenuation of micro power cuts produced by the converter that cause the malfunction of computers, automatons and other susceptible equipment.

Manufacturing characteristics

All the versions have the following features in common:

- Encapsulated in flame retardant resin.
- Connection terminals made of copper, welded and inserted in blocks to prevent hazards caused by expansion that may lead to poor connection.
- Option of mounting on **DIN rail up to 16 A**, rest with screws.
- All the parts of these inductances are live and encapsulated in resin, which makes them especially suitable for use in damp, saline and corrosive environments.
- They have greater resistance to current surges and transient harmonics.
- Greater mechanical resistance to vibrations and undesirable movements.
- Safety Class I.
- All the inductances are checked automatically one by one and the compliance report is created based on the respective standard.

Electrical diagram

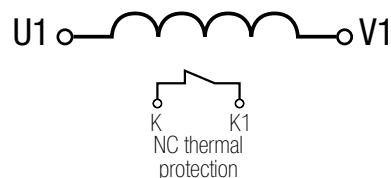



R SERIES

Encapsulated for harmonic filtering in single-phase lines · Network **220 V - 260 V**

Terminal types

Terminal blocks	External mm				Maximum tightening torque N-m	Primary Current A		Secondary Current A	
	A	B	C	Ø		From	To	From	To
	Terminal M4	9.7	16	10.1		M4	1.1	2.5	16
Terminal M5	15.5	21.5	15.6	M5	2.5	40	100	16	31.5
Terminal M6	15.5	21.5	15.6	M6	4	-	-	40	50
Terminal M8	15.5	21.5	15.6	M8	4.5	-	-	63	100

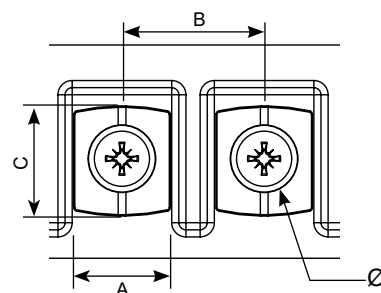

Theoretical data - standard model

Current A	Reference	L mH	Motor power	
			kVA	HP
2.5	R2.5	8.785	0.23	0.31
4	R4	5.491	0.37	0.5
5	R5	4.393	0.46	0.6
6.3	R6.3	3.486	0.55	0.75
8	R8	2.745	0.75	1
10	R10	2.196	1.1	1.5
12.5	R12.5	1.757	1.5	2
16	R16	1.373	1.85	2.5
20	R20	1.098	2.2	3
25	R25	0.879	3	4
31.5	R31.5	0.697	4	5.5
40	R40	0.549	5.5	7.5
50	R50	0.439	6.5	8.7
63	R63	0.349	7.5	10
80	R80	0.275	11	15
100	R100	0.220	14	18.7

Measurements

Current A	Ref.	External dimensions mm			Fastening elements mm			Weight kg
		A	B	C	D	E	Ø	
2.5	R2.5	50	97	84	80	34	6	0.76
4	R4	50	97	89	80	34	6	0.78
5	R5	50	97	94	80	34	6	0.94
6.3	R6.3	75	96	95	80	56	6	1.3
8	R8	75	96	95	80	56	6	1.3
10	R10	75	96	95	80	56	6	1.3
12.5	R12.5	75	96	95	80	56	6	1.3
16	R16	75	96	110	80	56	6	1.8
20	R20	84	102	120	86	65	6	2.7
25	R25	96	112	126	96	77	6	2.8
31.5	R31.5	96	112	126	96	77	6	2.9
40	R40	108	122	155	106	89	6	5
50	R50	126	145	167	125	102	6	5.6
63	R63	126	145	187	125	102	7	8.1
80	R80	126	145	187	125	102	7	8.3
100	R100	150	165	200	145	125	7	10.6

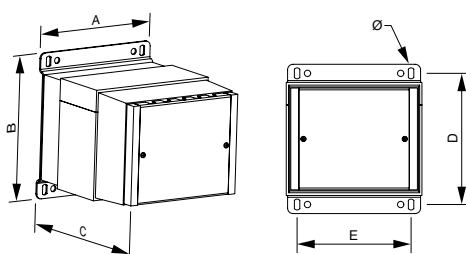

RTLX SERIES

For harmonic filtering in three-phase lines · Network 380 V - 460 V

**Definition and applications**

The RTLX series are inductances for harmonic filtering in three-phase installations. Specific applications:

- Reduction of current harmonics generated by electronic equipment, reducing current consumption and improving the power factor.
- Reduction of the crest factor of the current waveform, lengthening the service life of the equipment.
- Attenuation of micro power cuts produced by the converter that cause the malfunction of computers, automatons and other susceptible equipment.

Manufacturing characteristics

All the versions have the following features in common:

- Dual protection, resin + anti-flash varnish.
- Thermal protection against overtemperature included.
- Safety Class I.
- All the inductances are checked automatically one by one and the compliance report is created based on the respective standard.

Technical features - standard model

Current	2.5 A to 1000 A
Insulators	Class F - 155 °C
Winding	Class HC - 200 °C
Room temperature	45 °C
Frequency	50-60 Hz
Noise	≤ 60 dB
Protection rating	IP00
Cooling	AN
Mounting	With screws
Standards	IEC/EN/UNE-EN 60076-6, CE
Protection	Class I
Operation	Continuous
Test voltage	3 kV (1 min., 50 Hz) between coil and ground

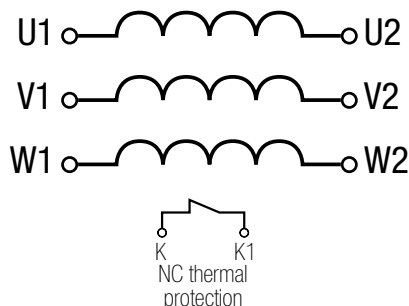
Electrical diagram

RTLX SERIES

For harmonic filtering in three-phase lines · Network 380 V - 460 V

Theoretical data - standard model

Current A	Reference	L mH	Motor power	
			kVA	HP
2.5	RTLX2.5	11.762	0.75	1
4	RTLX4	7.351	1.1	1.5
5	RTLX5	5.881	1.5	2
6.3	RTLX6.3	4.667	2.2	3
8	RTLX8	3.676	3	4
10	RTLX10	2.941	4	5.5
12.5	RTLX12.5	2.352	5.5	7.5
16	RTLX16	1.838	6.5	8.8
20	RTLX20	1.47	7.5	10
25	RTLX25	1.176	11	15
31.5	RTLX31.5	0.933	15	20
40	RTLX40	0.735	18.5	25
50	RTLX50	0.588	22	30
63	RTLX63	0.467	30	40
80	RTLX80	0.368	37	50
100	RTLX100	0.294	45	60
125	RTLX125	0.235	55	75
160	RTLX160	0.184	75	100
200	RTLX200	0.147	90	125
250	RTLX250	0.118	110-132	150-180
315	RTLX315	0.093	150-160	205-220
400	RTLX400	0.074	185-200	250-270
500	RTLX500	0.059	220-250	300-340
630	RTLX630	0.047	280-315	405-425
800	RTLX800	0.037	370-400	500-540
1000	RTLX1000	0.029	440-500	600-680

Measurements

Current A	Ref.	External dimensions mm			Fastening elements mm			Weight kg
		A	B	C	D	E	Ø	
2.5	RTLX2.5	120	74	107	44	100	6	1.4
4	RTLX4	120	74	107	44	100	6	1.4
5	RTLX5	120	74	107	44	100	6	1.6
6.3	RTLX6.3	120	74	107	44	100	6	1.9
8	RTLX8	120	84	107	54	100	6	2.3
10	RTLX10	120	84	107	54	100	6	2.7
12.5	RTLX12.5	150	125	185	64	100	6	3.9
16	RTLX16	150	135	185	74	100	6	5.1
20	RTLX20	150	140	185	79	100	6	5.9
25	RTLX25	150	145	185	84	100	6	6.5
31.5	RTLX31.5	150	155	185	94	100	6	7.9
40	RTLX40	150	165	185	104	100	6	9.2
50	RTLX50	180	150	220	89	120	6	10.6
63	RTLX63	180	155	220	94	120	6	11.6
80	RTLX80	180	165	220	104	120	6	13.7
100	RTLX100	180	205	220	144	120	6	20.7
125	RTLX125	180	185	220	154	120	9	22.8
160	RTLX160	180	207	220	169	120	9	26.1
200	RTLX200	240	173	290	129	160	10	32.8
250	RTLX250	240	188	290	144	160	10	38.5
315	RTLX315	340	234	375	135	310	10	46.5
400	RTLX400	340	254	375	155	310	10	57.0
500	RTLX500	340	289	375	190	310	10	74.0
630	RTLX630	360	371	525	195	300	10	102.0
800	RTLX800	360	381	525	205	300	10	115.0
1000	RTLX1000	360	421	525	245	300	10	142.0

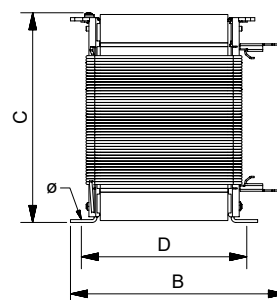
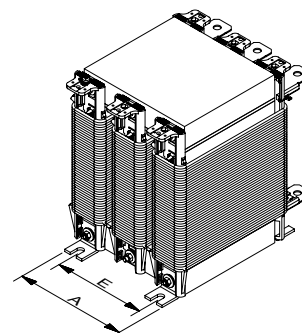

RTLX SERIES

For harmonic filtering in three-phase lines · Network 380 V - 460 V

Feature plate structure

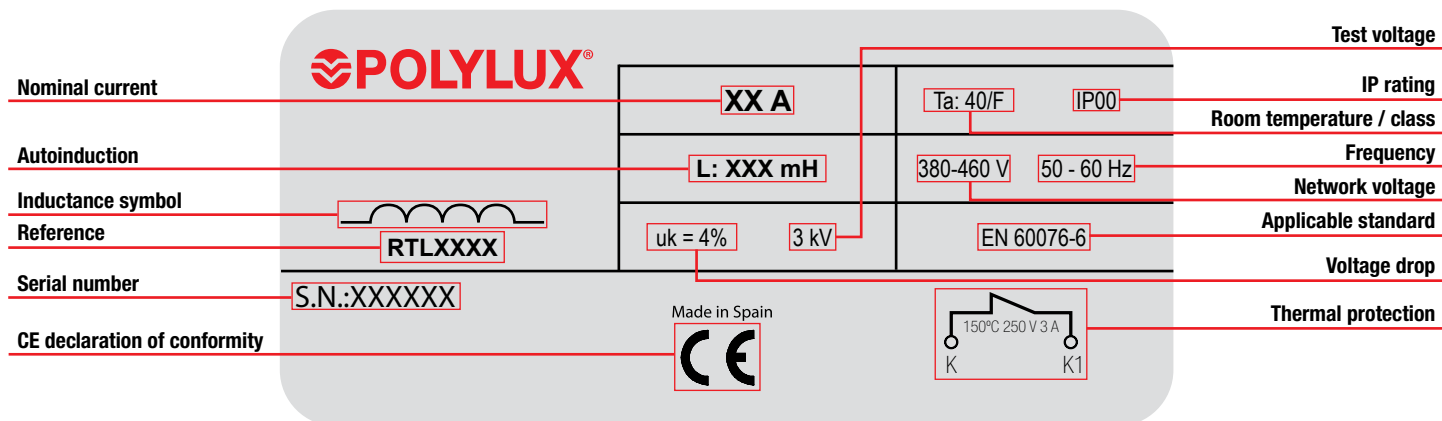



RTL SERIES

Encapsulated for harmonic filtering in three-phase lines · Network 380 V - 460 V



Technical features - standard model

Current	2.5 A to 125 A
Insulators	Class F - 155 °C
Winding	Class HC - 200 °C
Room temperature	45 °C
Frequency	50-60 Hz
Noise	≤ 45 dB
Protection rating	IP20
Cooling	AN
Mounting	With screws
Standards	IEC/EN/UNE-EN 60076-6, CE
Protection	Class I
Operation	Continuous
Test voltage	3 kV (1 min., 50 Hz) between coil and ground

Definition and applications

The RTL series are inductances for harmonic filtering in three-phase installations.

Specific applications:

- Reduction of current harmonics generated by electronic equipment, reducing current consumption and improving the power factor.
- Reduction of the crest factor of the current waveform, lengthening the service life of the equipment.
- Attenuation of micro power cuts produced by the converter that cause the malfunction of computers, automatons and other susceptible equipment.

Manufacturing characteristics

All the versions have the following features in common:

- Encapsulated in flame retardant resin.
- Connection terminals made of copper, welded and inserted in blocks to prevent hazards caused by expansion that may lead to poor connection.
- All the live parts of these transformers are encapsulated in resin, which is particularly indicated for working in damp, saline and corrosive environments.
- They have greater resistance to current surges and transient harmonics.
- Greater mechanical resistance to vibrations and undesirable movements.
- Safety Class I.
- All the inductances are checked automatically one by one and the compliance report is created based on the respective standard.

Electrical diagram

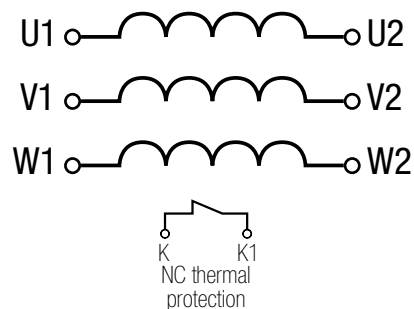



RTL SERIES

Encapsulated for harmonic filtering in three-phase lines · Network **380 V - 460 V**

Terminal types

Terminal blocks	External mm				Maximum tightening torque N·m	Primary Current A		Secondary Current A	
	A	B	C	Ø		From	To	From	To
	Terminal M5	15.5	21.5	15.6		M5	2.5	40	2.5
Terminal M6	15.5	21.5	15.6	M6	4	50	63	50	53
Terminal M8	15.5	21.5	15.6	M8	4.5	80	125	80	125

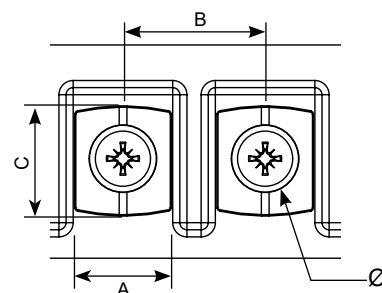

Theoretical data - standard model

Current A	Reference	L mH	Motor power	
			kVA	HP
2.5	RTL2.5	11.762	0.75	1
4	RTL4	7.351	1.1	1.5
5	RTL5	5.881	1.5	2
6.3	RTL6.3	4.667	2.2	3
8	RTL8	3.676	3	4
10	RTL10	2.941	4	5.5
12.5	RTL12.5	2.352	5.5	7.5
16	RTL16	1.838	6.5	8.8
20	RTL20	1.47	7.5	10
25	RTL25	1.176	11	15
31.5	RTL31.5	0.933	15	20
40	RTL40	0.735	18.5	25
50	RTL50	0.588	22	30
63	RTL63	0.467	30	40
80	RTL80	0.368	37	50
100	RTL100	0.294	45	60
125	RTL125	0.235	55	75

Measurements

Current A	Ref.	External dimensions mm			Fastening elements mm			Weight kg
		A	B	C	D	E	Ø	
2.5	RTL2.5	135	145	108	125	102	7	1.5
4	RTL4	135	145	108	125	102	7	1.7
5	RTL5	135	145	108	125	102	7	2
6.3	RTL6.3	135	145	108	125	102	7	2.5
8	RTL8	135	145	108	125	102	7	2.7
10	RTL10	170	165	138	145	125	7	3.4
12.5	RTL12.5	170	165	138	145	125	7	3.9
16	RTL16	170	165	138	145	125	7	5.3
20	RTL20	210	198	185	178	173	7	6
25	RTL25	210	198	185	178	173	7	7.5
31.5	RTL31.5	210	198	185	178	173	7	9.7
40	RTL40	210	198	185	178	173	7	10.2
50	RTL50	280	190	205	80	250	9	13.9
63	RTL63	280	190	205	100	250	9	16.7
80	RTL80	280	190	205	115	250	9	20.1
100	RTL100	280	220	205	110	250	9	24.5
125	RTL125	340	220	255	106	310	9	30.3

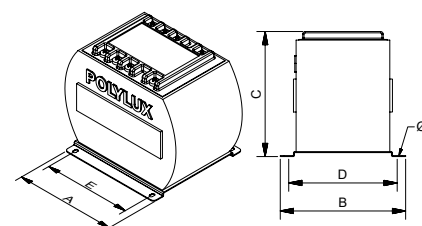

From 2.5 A to 40 A

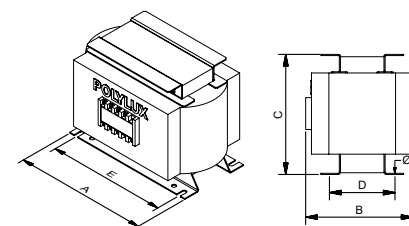

From 50 A



RTL SERIES

Encapsulated for harmonic filtering in three-phase lines · Network 380 V - 460 V

Feature plate structure

1	U1	2	V1	3	W1	4	k	5	k1	V
6	U2	7	V2	8	W2	9		10		V

Primary connection

Nominal current

IP rating

Autoinduction

EAN bar code

Frequency

Reference

Secondary connection

Thermally protection connection

Inductance symbol

CE declaration of conformity

Primary protection

Insulators

Serial number

Test voltage

Standard

RTOX SERIES

For harmonic filtering in three-phase lines at the converter output · Network 400 V



Definition and applications

The RTOX series are inductances for harmonic filtering in three-phase lines at the converter output.

Specific applications:

- Attenuation of voltage peaks at the converter output, protecting the dielectric elements of the motor against premature damage caused by this.
- Reduction of the reflection effect due to the length of the cable between the converter and the motor. This reflection effect amplifies the voltage values in the motor terminals.

Manufacturing characteristics

All the versions have the following features in common:

- Dual protection, resin + anti-flash varnish.
- Thermal protection against overtemperature included.
- Safety Class I.
- All the inductances are checked automatically one by one and the compliance report is created based on the respective standard.

Technical features - standard model

Current	2.5 A to 630 A
Insulators	Class F - 155 °C
Winding	Class HC - 200 °C
Room temperature	45 °C
Frequency	50-60 Hz
Noise	≤ 60 dB
Protection rating	IP00
Cooling	AN
Mounting	With screws
Standards	IEC/EN/UNE-EN 60076-6, CE
Protection	Class I
Operation	Continuous
Test voltage	3 kV (1 min., 50 Hz) between coil and ground

Electrical diagram

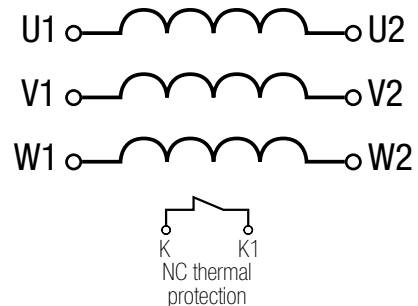

RTOX SERIES

For harmonic filtering in three-phase lines at the converter output · Network 400 V

Theoretical data - standard model

Current A	Reference	L mH	cdt (%)
2.5	RTOX2.5	8.821	3
4	RTOX4	5.513	3
5	RTOX5	4.411	3
6.3	RTOX6.3	3.501	3
8	RTOX8	2.757	3
10	RTOX10	2.205	3
12.5	RTOX12.5	1.764	3
16	RTOX16	1.378	3
20	RTOX20	1.103	3
25	RTOX25	0.882	3
31.5	RTOX31.5	0.700	3
40	RTOX40	0.551	3
50	RTOX50	0.441	3
63	RTOX63	0.350	3
80	RTOX80	0.276	3
100	RTOX100	0.221	3
125	RTOX125	0.176	3
160	RTOX160	0.138	3
200	RTOX200	0.110	3
250	RTOX250	0.088	3
315	RTOX315	0.070	3
400	RTOX400	0.055	3
500	RTOX500	0.044	3
630	RTOX630	0.035	3

Measurements

Current A	Ref.	External dimensions mm			Fastening elements mm			Weight kg
		A	B	C	D	E	Ø	
2.5	RTOX2.5	150	110	185	49	100	6	2
4	RTOX4	150	120	185	59	100	6	3.2
5	RTOX5	150	120	185	59	100	6	3.3
6.3	RTOX6.3	150	120	185	59	100	6	3.4
8	RTOX8	150	125	185	64	100	6	4
10	RTOX10	150	130	185	69	100	6	4.7
12.5	RTOX12.5	150	135	185	74	100	6	5.4
16	RTOX16	150	140	185	79	100	6	6.3
20	RTOX20	150	150	185	89	100	6	7.8
25	RTOX25	150	155	185	94	100	6	8.5
31.5	RTOX31.5	180	150	220	89	120	6	11.1
40	RTOX40	180	165	220	104	120	6	13.9
50	RTOX50	180	180	220	119	120	6	16.7
63	RTOX63	180	205	220	144	120	6	21.3
80	RTOX80	240	175	295	114	160	6	27.3
100	RTOX100	240	190	295	129	160	6	32.4
125	RTOX125	240	215	295	154	160	9	40.7
160	RTOX160	340	219	375	120	310	10	38.7
200	RTOX200	340	239	375	140	310	10	49.1
250	RTOX250	340	259	375	160	310	10	59
315	RTOX315	340	294	375	195	310	10	77
400	RTOX400	340	319	375	220	310	10	93
500	RTOX500	410	319	445	210	385	12	128
630	RTOX630	410	359	445	250	385	12	159

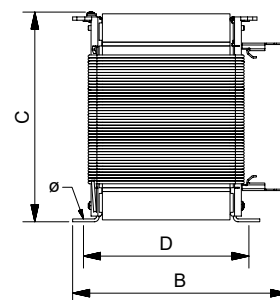
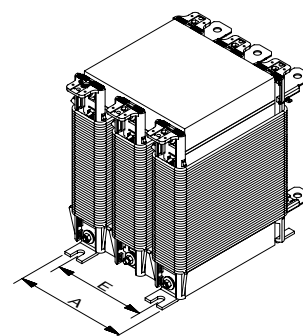

RTOX SERIES

For harmonic filtering in three-phase lines at the converter output · Network 400 V

Feature plate structure

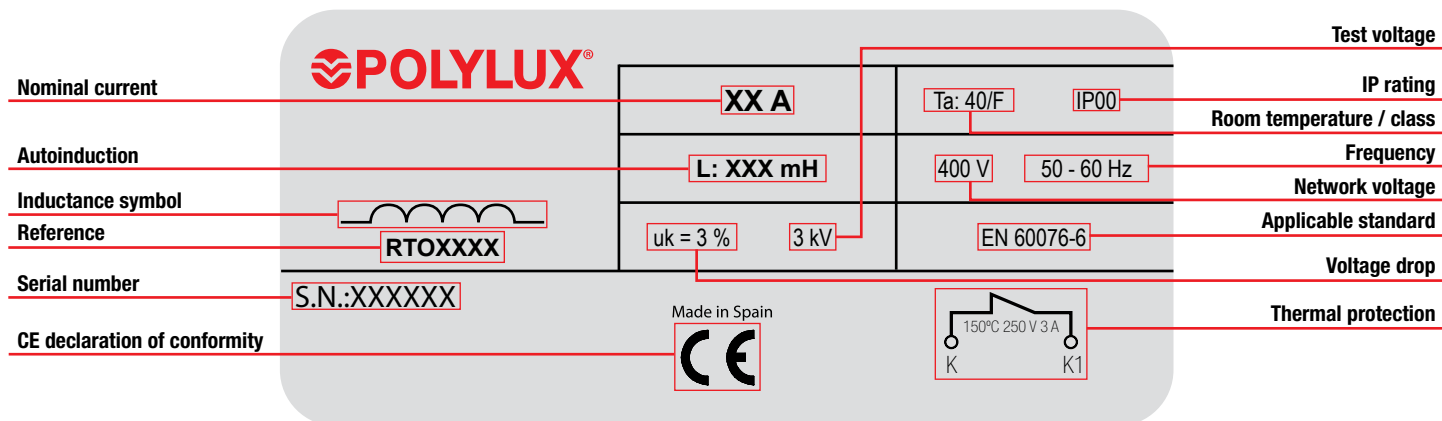

FTOX SERIES

With a three-phase converter output filter · For converter-motor distances > 30 m · Network 400 V



Technical features - standard model

Current	2.5 A to 125 A
Insulators	Class F - 155 °C
Winding	Class HC - 200 °C
Room temperature	45 °C
Frequency	50-60 Hz
Noise	≤ 60 dB
Protection rating	IP00
Cooling	AN
Mounting	With screws
Standards	IEC/EN/UNE-EN 60076-6, CE
Protection	Class I
Operation	Continuous
Test voltage	3 kV (1 min., 50 Hz) between coil and ground

Definition and applications

The FTOX series are inductances with a capacitor filter for harmonic filtering in three-phase installations at the converter output.

Specific applications:

- Attenuation of voltage peaks at the converter output, protecting the dielectric elements of the motor against premature damage caused by this.
- Reduction of the reflection effect due to the length of the cable between the converter and the motor. This reflection effect amplifies the voltage values in the motor terminals.
- It is advisable to use these inductances for lengths of more than 30 m between the converter and motor.

Manufacturing characteristics

All the versions have the following features in common:

- Dual protection, resin + anti-flash varnish.
- Thermal protection against overtemperature included.
- Safety Class I.
- All the inductances are checked automatically one by one and the compliance report is created based on the respective standard.

Electrical diagram

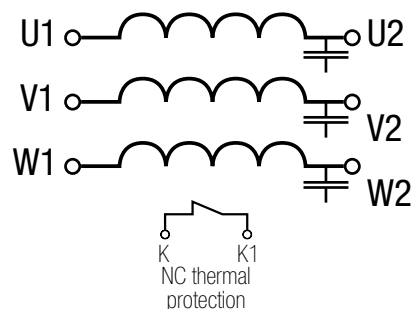

FTOX SERIES

With a three-phase converter output filter · For converter-motor distances > 30 m · Network 400 V

Theoretical data - standard model

Current A	Reference	L mH
2.5	FTOX2.5	8.821
4	FTOX4	5.513
5	FTOX5	4.411
6.3	FTOX6.3	3.501
8	FTOX8	2.757
10	FTOX10	2.205
12.5	FTOX12.5	1.764
16	FTOX16	1.378
20	FTOX20	1.103
25	FTOX25	0.882
31.5	FTOX31.5	0.700
40	FTOX40	0.551
50	FTOX50	0.441
63	FTOX63	0.350
80	FTOX80	0.276
100	FTOX100	0.221
125	FTOX125	0.176

Measurements

Current A	Ref.	External dimensions mm			Fastening elements mm			Weight kg
		A	B	C	D	E	Ø	
2.5	FTOX2.5	150	180	185	49	100	6	2.3
4	FTOX4	150	190	185	59	100	6	3.5
5	FTOX5	150	190	185	59	100	6	3.6
6.3	FTOX6.3	150	190	185	59	100	6	3.7
8	FTOX8	150	195	185	64	100	6	4.3
10	FTOX10	150	200	185	69	100	6	5
12.5	FTOX12.5	150	205	185	74	100	6	5.7
16	FTOX16	150	210	185	79	100	6	6.6
20	FTOX20	150	220	185	89	100	6	8.1
25	FTOX25	150	225	185	94	100	6	8.8
31.5	FTOX31.5	180	220	220	89	120	6	11.4
40	FTOX40	180	235	220	104	120	6	14.2
50	FTOX50	180	250	220	119	120	6	17
63	FTOX63	180	275	220	144	120	6	21.6
80	FTOX80	240	245	290	114	160	6	27.6
100	FTOX100	240	260	290	129	160	6	32.7
125	FTOX125	240	285	290	154	160	9	41

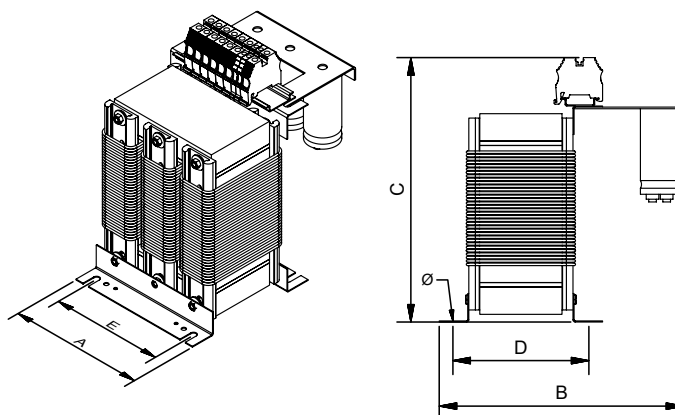

FTOX SERIES

With a three-phase converter output filter · For converter-motor distances > 30 m · Network 400 V

Feature plate structure

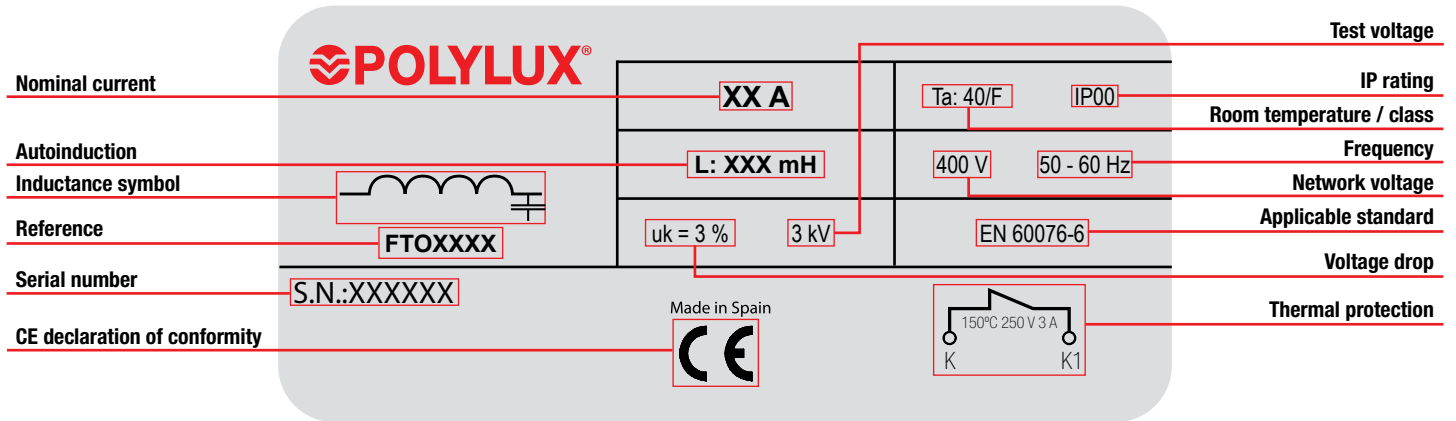

RTFX SERIES

Three-phase rejection inductances for capacitor batteries, $p = 7\%$ · Network 400 V a 50 Hz

**Definition and applications**

The RTFX series are three-phase rejection inductances for capacitor batteries.

Specific applications:

- They prevent resonances between the power transformer inductance and the capacitance of the capacitor battery.
- They eliminate surge currents and overvoltage in the transformer and in the capacitor battery.
- They protect the condensers against harmonics, preventing their premature ageing.
- They limit the capacitor battery connection peaks, thus increasing their service life and reducing micro power cuts in the supply voltage.

Manufacturing characteristics

All the versions have the following features in common:

- Dual protection, resin + anti-flash varnish.
- Thermal protection against overtemperature included.
- Safety Class I.
- Option of manufacturing with different filter factors, $p = 5.67\%$ (RTF5X, capacitor voltage 440 V to 50 Hz and resonance frequency 210 Hz) and $p=14\%$ (RTF14X, voltage 460 V to 50 Hz and resonance frequency 135 Hz); both factors cover the 5 kVar to 100 kVar power range.
- All the inductances are checked automatically one by one and the compliance report is created based on the respective standard.

Technical features - standard model

Capacitor power	5 kVAR to 100 kVAR
Insulators	Class F - 155 °C
Winding	Class HC - 200 °C
Room temperature	45 °C
Frequency	50 Hz
Noise	≤ 60 dB
Protection rating	IP00
Cooling	AN
Mounting	With screws
Standards	UNE-EN 60289, CE
Protection	Class I
Operation	Continuous
Test voltage	3 kV (1 min., 50 Hz) between coil and ground

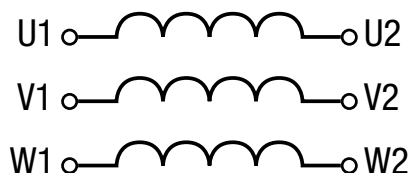
Electrical diagram

RTFX SERIES

Three-phase rejection inductances for capacitor batteries, $p = 7\%$ · Network 400 V a 50 Hz

Theoretical data - standard model

Capacitor power kVar	Filter factor $p=7\%$ Capacitor voltage 440 V at 50 Hz Resonance frequency 189 Hz		
	Reference	Delivered power kVar	Nominal current A
5	RTFX5	4.4	6.8
10	RTFX10	8.9	13.6
12.5	RTFX12.5	11.1	17
15	RTFX15	13.3	20.4
20	RTFX20	17.8	27.2
25	RTFX25	22.2	34
30	RTFX30	26.7	40.8
40	RTFX40	35.5	54.4
50	RTFX50	44.4	68
60	RTFX60	53.3	82
80	RTFX80	71.1	109
100	RTFX100	88.8	136

Measurements

Capacitor power kVar	Ref.	External dimensions mm			Fastening elements mm			Weight kg
		A	B	C	D	E	Ø	
5	RTFX5	150	111	185	85	100	9	5.6
10	RTFX10	150	126	185	100	100	9	7.6
12.5	RTFX12.5	150	141	185	115	100	9	9.5
15	RTFX15	180	126	220	100	120	9	11.1
20	RTFX20	180	131	220	105	120	9	12.1
25	RTFX25	180	141	220	115	120	9	14
30	RTFX30	180	156	220	130	120	9	16.8
40	RTFX40	180	176	220	150	120	9	20.9
50	RTFX50	180	186	220	160	120	9	22.9
60	RTFX60	180	201	220	175	120	9	25.8
80	RTFX80	240	161	290	135	160	9	33.2
100	RTFX100	240	186	290	160	160	9	40.8

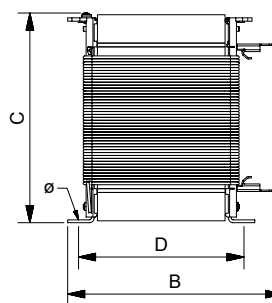
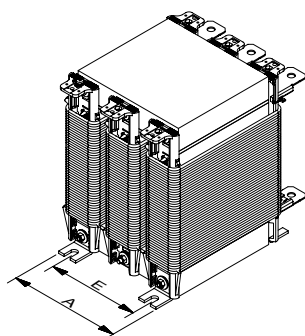

RTFX SERIES

Three-phase rejection inductances for capacitor batteries, $p = 7\%$ • Network 400 V a 50 Hz

Feature plate structure

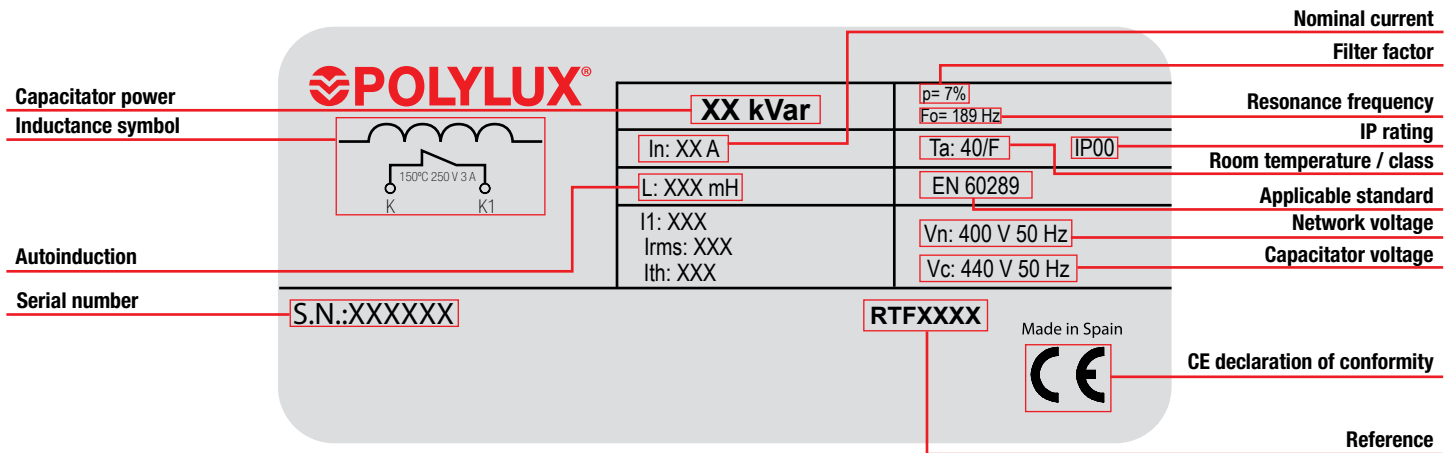



PXR SERIES

Control, manoeuvre and insulation · Input 15-0-15-230-400 V · Output 230 V · IP00



Up to 400 VA



From 500 VA

Definition and applications

The PXR transformers are specially designed to adapt voltages in manoeuvre and control, in both household and industrial environments. They are mainly used to ensure the galvanic isolation of installations for safety reasons and to create neutrals referenced to ground. They can also be used in installations that require safety voltages (<50V). The ±15% adjustment facilitates the adaptation of the output depending on the voltage drop in the line.

Manufacturing characteristics

All the versions have the following features in common:

- Anti-flash dip varnishing. Ensures greater compactation, insulation and noise elimination.
- Adjustment to adapt the primary voltage, with the possibility of correcting the voltage drop in the line.
- Connection terminals made of copper, welded and inserted in blocks to prevent hazards caused by expansion that may lead to poor connection.
- Option of mounting on **DIN rail up to 250 VA**.

Technical features - standard model

Power	40 VA to 1600 VA
Insulators	Class B - 130 °C
Winding	Class HC - 200 °C
Room temperature	45 °C
Frequency	50-60 Hz
Noise	≤45 dB
Protection rating	IP00
Cooling	AN
Mounting	With screws (for all powers) Mounting on DIN 46277/3 rail (up to 250 VA)
Standards	IEC/EN/UNE-EN 61558, CE
Voltage selection	Due to changing terminals
Operation	Continuous
Test voltage	4.6 kV (1 min., 50 Hz) between primary and secondary 3.2 kV (1 min., 50 Hz) between primary and ground 2.5 kV (1 min., 50 Hz) between secondary and ground

Electrical diagram

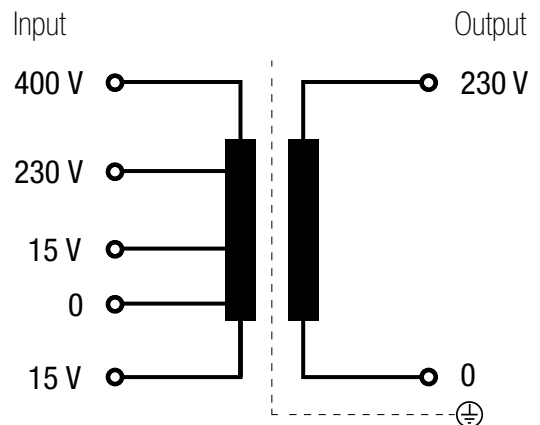



PXR SERIES

Control, manoeuvre and insulation · Input **15-0-15-230-400 V** · Output **230 V** · IP00

Electrical connection

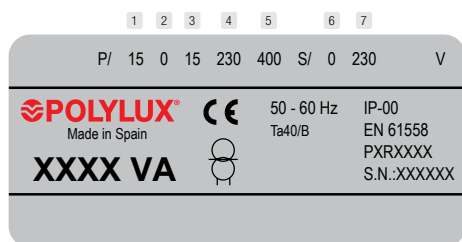

Input:

- 215 V | Connection: 3-4
- 230 V | Connection: 2-4
- 245 V | Connection: 1-4
- 400 V | Connection: 2-5
- 385 V | Connection: 3-5
- 415 V | Connection: 1-5

Output:

- 230 V | Connection: 6-7

Terminal type

Terminal block	External mm			Maximum tightening torque N-m
	A	B	C	
Terminal 4	3.3	7.5	4.5	0.5

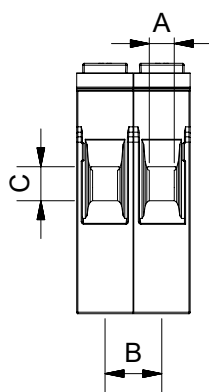

Theoretical data - standard model

Power VA	Reference	Input current A		Output current A	Maximum cross-section input conductor (mm²)				Maximum cross-section output conductor (mm²)		Input protections (A) (MCB -> D / Fuse -> aM)		Output protections (A) (MCB -> C / Fuse -> gG)
		230 V	400 V	230 V	230 V		400 V		Flexible	Rigid	230 V	400 V	
					Flexible	Rigid	Flexible	Rigid					
40	PXR40	0.17	0.10	0.17	0.5	0.5	0.5	0.5	0.5	0.5	0.4 (-/T)	0.2 (-/T)	0.16 (-/T)
63	PXR63	0.27	0.16	0.27	0.5	0.5	0.5	0.5	0.5	0.5	0.63 (-/T)	0.315 (-/T)	0.25 (-/T)
100	PXR100	0.43	0.25	0.43	0.5	1	0.5	0.5	0.5	1	1 (-/T)	0.5 (-/T)	0.4 (-/T)
160	PXR160	0.70	0.40	0.70	0.5	1	0.5	0.5	0.5	1	1.6	1	0.63 (-/T)
200	PXR200	0.87	0.50	0.87	0.5	1	0.5	1	0.5	1	2	1	0.8 (-/T)
250	PXR250	1.09	0.63	1.09	0.5	1	0.5	1	0.5	1	2.5	1.25	1
315	PXR315	1.37	0.79	1.37	0.5	1	0.5	1	0.5	1	3.15	1.6	1.25
400	PXR400	1.74	1.00	1.74	1	1.5	0.5	1	1	1.5	4	2	1.6
500	PXR500	2.17	1.25	2.17	1	1.5	0.5	1	1	1.5	5	2.5	2
630	PXR630	2.74	1.58	2.74	1	1.5	1	1.5	1	1.5	6	3.15	2.5
800	PXR800	3.48	2.00	3.48	1	1.5	1	1.5	1	1.5	8	4	4
1000	PXR1000	4.35	2.50	4.35	1.5	2	1	1.5	1.5	2	10	5	4
1250	PXR1250	5.43	3.13	5.43	1.5	2	1	1.5	1.5	2	10	6.3	5
1600	PXR1600	6.96	4.00	6.96	1.5	2	1	1.5	1.5	2	16	8	6



PXR SERIES

Control, manoeuvre and insulation · Input 15-0-15-230-400 V · Output 230 V · IP00

Measurements

Power VA	Ref.	External dimensions mm			Fastening elements mm			Weight kg
		A	B	C	D	E	Ø	
40	PXR40	75	67	89.5	56	62.5	6	0.9
63	PXR63	75	72	89.5	61	62.5	6	1.1
100	PXR100	75	82	89.5	71	62.5	6	1.4
160	PXR160	84	93	102	81	70	6	2.2
200	PXR200	96	88	106	72	80	6	2.4
250	PXR250	96	98	106	82	80	6	3
315	PXR315	108	98	109	83	90	6	3.8
400	PXR400	108	108	109	93	90	6	4.5
500	PXR500	126	110	115	75	106	8	5.3
630	PXR630	126	120	115	95	106	8	7.3
800	PXR800	126	130	115	105	106	8	8.3
1000	PXR1000	150	135	135	102	125	8	10.8
1250	PXR1250	150	155	135	122	125	8	13.1
1600	PXR1600	150	175	135	142	125	8	16.9

Up to PXR400

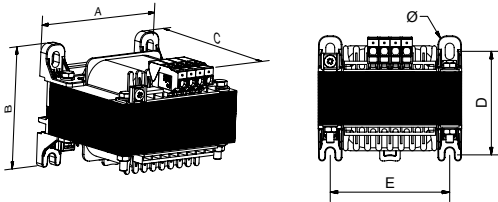

From PXR500

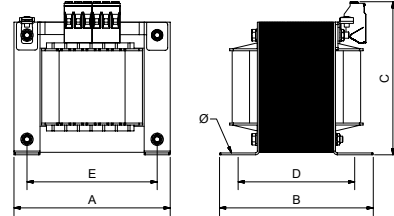

On-request manufacturing options (please see prices)

Power	From 25 VA to 5000 VA
Protections	Fuse holder terminal
Shields	Primary / secondary, primary / ground and secondary / ground

Feature plate structure

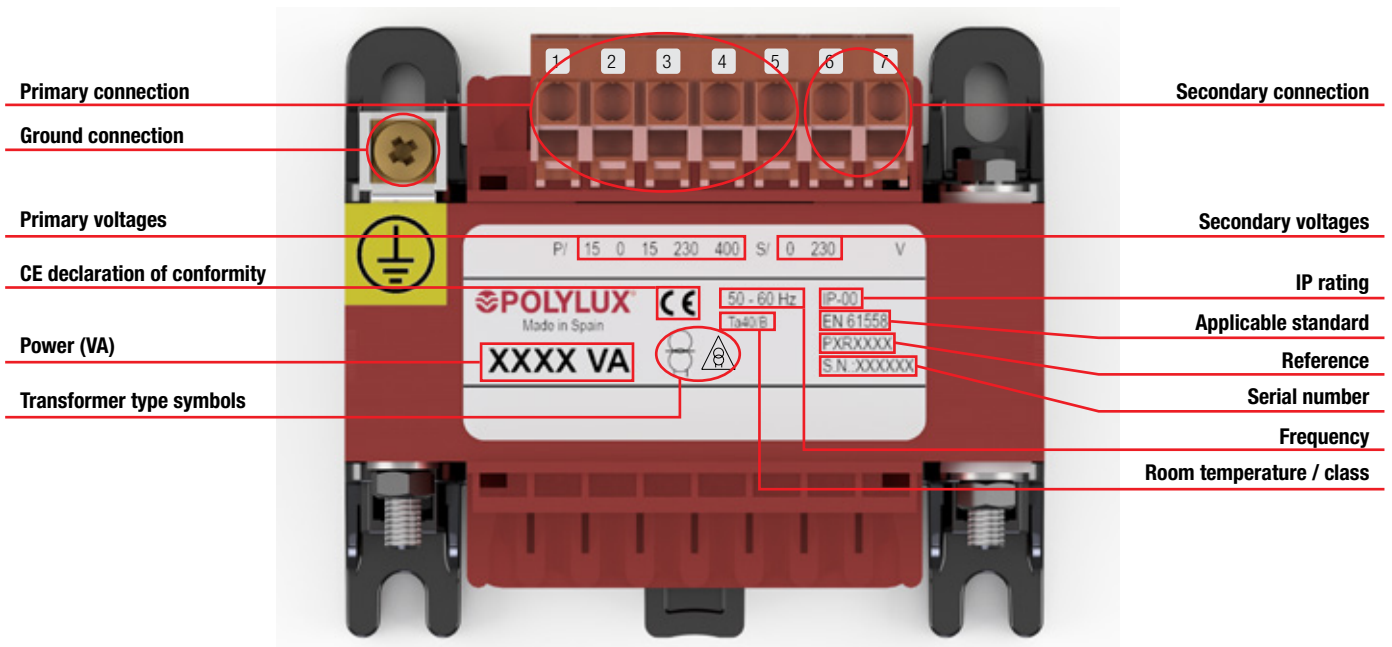



TK SERIES

Isolation · Input 230 V · Output 230 V

Definition and applications

The TK transformers are mainly used to isolate circuits and increase or reduce the output voltage if this is requested as a special assembly.

They are also used to change the installation neutral system for changing from a two-phase to a single-phase network or vice versa. (This case means creating an artificial neutral).

In installations with a certain amount of electrical noise, the TK series helps improve the electrical network quality in secondary.

For example: Supplying equipment that requires the neutral reference and has only two phases. The ability to insulate more sensitive systems in a control panel. Increasing catenary voltage in the railway sector and reducing it to supply track control panels.

Manufacturing characteristics

The TK series are perfect for supplying continuous power to industrial, tertiary or residential installations or machinery. They are the POLYLUX single-phase range with the highest power.

Equipment with four different finishes based on sealing.

All the versions have the following features in common:

- Anti-flash dip varnishing. Ensures greater compactation, insulation and noise elimination.
- Welded copper connection end sleeves inserted into the terminal block to prevent hazards caused by expansion that leads to poor connection.
- All the transformers are checked automatically one by one and the compliance test report is created in accordance with the corresponding standard.



TKX

- IP00 protection rating.
- Power from 3.15 kVA to 50 kVA.
- Total impregnated in anti-flash varnish.
- Hoisting elements included.



TKW

- IP23 rating (IK08).
- Power from 3.15 kVA to 50 kVA.
- Metal box painted with RAL7035 polyester resin.
- High resistance to corrosion.
- Hoisting elements included.
- Detachable top and front cover.
- Cable outlet with cable gland.



TKZ

- IP54 rating / 65 (IK10).
- Power from 3.15 kVA to 50 kVA.
- Metal box painted with RAL7035 polyester resin.
- High resistance to corrosion.
- Hoisting elements included.
- Detachable top cover.
- Stuffing box cover for cable input depending on installation needs.
- With silentblock.



TKE

- **Encapsulated in flame retardant resin.**
- IP20 protection rating.
- Power from 3.15 kVA to 50 kVA.
- Protection against damp, saline and corrosive environments.
- Greater resistance to surge currents.
- Greater resistance to transient harmonics.
- Greater mechanical resistance to undesirable vibrations.
- Uniform heat dissipation.
- Hoisting elements included.



TK SERIES

Isolation · Input 230 V · Output 230 V

Technical features - standard model

Power	3.15 kVA to 50 kVA
Standard voltage	Input 230 V // Output 230 V
Standard frequency	50-60 Hz
Noise	≤ 45 dB
Windings	Class HC-200 °C
Insulators	Class F - 155 °C ≤ 25 kVA (31.5 kVA TKE) Class H - 180 °C ≥ 31.5 kVA (40 kVA TKE) <small>*More information in Technical Appendix (T.A.1)</small>
Class	I
Altitude	1000 m
Enclosure colour	RAL 7035
IP rating	IP00 (TKX) IP20 (TKE) IP23 (TKW) IP54 / 65 (TKZ)
IK rating	IK08 (TKW) IK10 (TKZ)
Paint class (ISO 12944)	C3 (TKW) C4 (TKZ)
Room temperature	45 °C
Standards	IEC/EN 61558, CE up to 31.5 kVA IEC/EN 60076, CE from 40 kVA
Test voltage	3 kV (1 min., 50 Hz)
Inrush	< 12 In
Ucc	≤ 4.7 %
K factor	4
Klixon	≤ 25 kVA (only TKE)
Operation	Continuous
Cooling	AN (TKX / TKE) - ANAN (TKW / TKZ)
Hoisting accessories	Hoisting elements

Electrical diagram

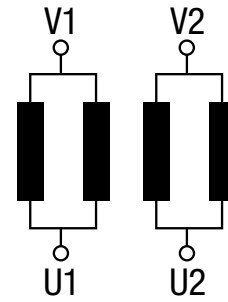

Connection

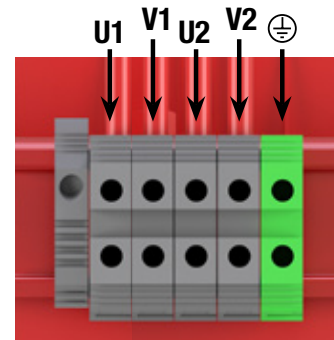

Terminal types

Terminals	External mm				Minimum conductor cross-section mm ²	Maximum tightening torque		TKX-TKW		TKE		TKZ	
	A	B	C	Ø		N·m	Lb·In	Power kVA		Power kVA		Power kVA	
								From	To	From	To	From	To
Terminal M5	15	18.5	14	M5	16	1.1	9.7	-	-	3.15	3.15	-	-
Power strip 1	Terminal 16	-	-	-	25	1.2	10.6	3.15	6.3	4	6.3	3.15	4
	Terminal 35	-	-	-	50	2.5	22.1	8	8	8	8	5	6.3
Power strip 2	Terminal 60	-	-	-	25	4.5	40	10	12.5	10	12.5	8	10
	Terminal 100	-	-	-	35	6.7	60	16	20	16	20	12.5	16
	Terminal 200	-	-	-	95	9	80	25	40	25	40	20	31.5
	Terminal 300	-	-	-	150	9	80	50	50	50	50	40	50

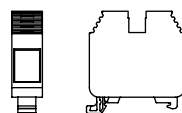
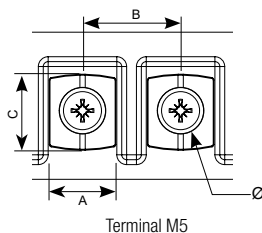

Power strip 1

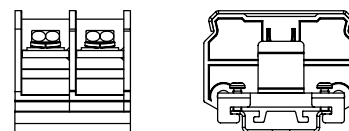

Power strip 2





TK SERIES

Isolation · Input 230 V · Output 230 V

Theoretical data - standard model

Power kVA	Reference	Insulation class	Current A		Protections A		Cable gland (TKW) / Stuffing boxes (TKZ)	
			Input	Output	Input	Output	ø max. (mm)	Quantity
TKX								
3.15	TKX3.15	F	13.7	13.7	20 (D/aM)	12 (C/gG)	-	-
4	TKX4	F	17.4	17.4	25 (D/aM)	16 (C/gG)	-	-
5	TKX5	F	21.7	21.7	40 (D/aM)	20 (C/gG)	-	-
6.3	TKX6.3	F	27.4	27.4	50 (D/aM)	25 (C/gG)	-	-
8	TKX8	F	34.8	34.8	62 (D/aM)	32 (C/gG)	-	-
10	TKX10	F	43.5	43.5	80 (D/aM)	40 (C/gG)	-	-
12.5	TKX12.5	F	54.3	54.3	100 (D/aM)	50 (C/gG)	-	-
16	TKX16	F	69.6	69.6	125 (D/aM)	63 (C/gG)	-	-
20	TKX20	F	87.0	87.0	160 (D/aM)	80 (C/gG)	-	-
25	TKX25	F	108.7	108.7	200 (D/aM)	100 (C/gG)	-	-
31.5	TKX31.5	H	137.0	137.0	250 (D/aM)	125 (C/gG)	-	-
40	TKX40	H	173.9	173.9	400 (D/aM)	160 (C/gG)	-	-
50	TKX50	H	217.4	217.4	500 (D/aM)	200 (C/gG)	-	-
TKW								
3.15	TKW3.15	F	13.7	13.7	20 (D/aM)	12 (C/gG)	18	2
4	TKW4	F	17.4	17.4	25 (D/aM)	16 (C/gG)	25	4
5	TKW5	F	21.7	21.7	40 (D/aM)	20 (C/gG)	25	4
6.3	TKW6.3	F	27.4	27.4	50 (D/aM)	25 (C/gG)	32	4
8	TKW8	F	34.8	34.8	62 (D/aM)	32 (C/gG)	32	4
10	TKW10	F	43.5	43.5	80 (D/aM)	40 (C/gG)	32	4
12.5	TKW12.5	F	54.3	54.3	100 (D/aM)	50 (C/gG)	32	4
16	TKW16	F	69.6	69.6	125 (D/aM)	63 (C/gG)	32	4
20	TKW20	F	87.0	87.0	160 (D/aM)	80 (C/gG)	32	4
25	TKW25	F	108.7	108.7	200 (D/aM)	100 (C/gG)	32	4
31.5	TKW31.5	H	137.0	137.0	250 (D/aM)	125 (C/gG)	32	8
40	TKW40	H	173.9	173.9	400 (D/aM)	160 (C/gG)	32	8
50	TKW50	H	217.4	217.4	500 (D/aM)	200 (C/gG)	32	8
TKZ								
3.15	TKZ3.15	F	13.7	13.7	20 (D/aM)	12 (C/gG)	18 - 25	2
4	TKZ4	F	17.4	17.4	25 (D/aM)	16 (C/gG)	18 - 25	2
5	TKZ5	F	21.7	21.7	40 (D/aM)	20 (C/gG)	18 - 25	2
6.3	TKZ6.3	F	27.4	27.4	50 (D/aM)	25 (C/gG)	22 - 32	2
8	TKZ8	F	34.8	34.8	62 (D/aM)	32 (C/gG)	22 - 32	2
10	TKZ10	F	43.5	43.5	80 (D/aM)	40 (C/gG)	22 - 32	2
12.5	TKZ12.5	F	54.3	54.3	100 (D/aM)	50 (C/gG)	22 - 32	2
16	TKZ16	F	69.6	69.6	125 (D/aM)	63 (C/gG)	22 - 32	2
20	TKZ20	F	87.0	87.0	160 (D/aM)	80 (C/gG)	22 - 32	2
25	TKZ25	F	108.7	108.7	200 (D/aM)	100 (C/gG)	22 - 32	2
31.5	TKZ31.5	H	137.0	137.0	250 (D/aM)	125 (C/gG)	22 - 32	2
40	TKZ40	H	173.9	173.9	400 (D/aM)	160 (C/gG)	22 - 32	2
50	TKZ50	H	217.4	217.4	500 (D/aM)	200 (C/gG)	22 - 32	2
TKE								
3.15	TKE3.15	F	13.7	13.7	20 (D/aM)	12 (C/gG)	-	-
4	TKE4	F	17.4	17.4	25 (D/aM)	16 (C/gG)	-	-
5	TKE5	F	21.7	21.7	40 (D/aM)	20 (C/gG)	-	-
6.3	TKE6.3	F	27.4	27.4	50 (D/aM)	25 (C/gG)	-	-
8	TKE8	F	34.8	34.8	62 (D/aM)	32 (C/gG)	-	-
10	TKE10	F	43.5	43.5	80 (D/aM)	40 (C/gG)	-	-
12.5	TKE12.5	F	54.3	54.3	100 (D/aM)	50 (C/gG)	-	-
16	TKE16	F	69.6	69.6	125 (D/aM)	63 (C/gG)	-	-
20	TKE20	F	87.0	87.0	160 (D/aM)	80 (C/gG)	-	-
25	TKE25	F	108.7	108.7	200 (D/aM)	100 (C/gG)	-	-
31.5	TKE31.5	F	137.0	137.0	250 (D/aM)	125 (C/gG)	-	-
40	TKE40	H	173.9	173.9	400 (D/aM)	160 (C/gG)	-	-
50	TKE50	H	217.4	217.4	500 (D/aM)	200 (C/gG)	-	-



TK SERIES

Isolation • Input 230 V • Output 230 V

Measurements

Power kVA	Dimensions mm							Weight kg
	Reference	A	B	C	D	E	Ø	
TKX								
3.15	TKX3.15	200	164	305	155	154	9	25
4	TKX4	240	144	355	122	180	11	30
5	TKX5	240	164	355	142	180	11	38
6.3	TKX6.3	280	180	419	136	210	11	52
8	TKX8	280	200	419	156	210	11	63
10	TKX10	320	250	480	144	240	11	70
12.5	TKX12.5	320	250	480	144	240	11	75
16	TKX16	320	270	480	164	240	11	84
20	TKX20	320	290	480	184	240	11	104
25	TKX25	320	310	480	204	240	11	125
31.5	TKX31.5	440	240	615	170	250	11	144
40	TKX40	440	260	615	190	250	11	171
50	TKX50	440	280	615	210	250	11	228
TKW								
3.15	TKW3.15	385	260	384	245	250	6	30
4	TKW4	458	340	500	300	300	12	36
5	TKW5	458	340	500	300	300	12	44
6.3	TKW6.3	528	418	644	375	345	12	64
8	TKW8	528	418	644	375	345	12	75
10	TKW10	597	415	710	375	345	12	82
12.5	TKW12.5	597	415	710	375	345	12	87
16	TKW16	597	415	710	375	345	12	96
20	TKW20	597	415	710	375	345	12	116
25	TKW25	597	415	710	375	345	12	135
31.5	TKW31.5	795	550	970	500	415	12	160
40	TKW40	795	550	970	500	415	12	186
50	TKW50	795	550	970	500	415	12	247

Power kVA	Dimensions mm							Weight kg
	Reference	A	B	C	D	E	Ø	
TKZ								
3.15	TKZ3.15	510	362	689	320	250	11	55
4	TKZ4	510	362	689	320	250	11	63
5	TKZ5	694	413	764	370	350	11	92
6.3	TKZ6.3	694	413	764	370	350	11	103
8	TKZ8	694	413	764	370	350	11	110
10	TKZ10	694	413	764	370	350	11	115
12.5	TKZ12.5	694	413	764	370	350	11	124
16	TKZ16	694	413	764	370	350	11	144
20	TKZ20	694	413	764	370	350	11	164
25	TKZ25	890	560	1148	520	426	13	209
31.5	TKZ31.5	890	560	1148	520	426	13	236
40	TKZ40	890	560	1148	520	426	13	260
50	TKZ50	890	560	1148	520	426	13	370
TKE								
3.15	TKE3.15	245	245	255	138	210	11	34
4	TKE4	240	158	353	122	180	11	44
5	TKE5	240	178	353	142	180	11	53
6.3	TKE6.3	280	202	419	142	210	11	74
8	TKE8	280	222	419	162	210	11	89
10	TKE10	320	225	480	126	240	11	93
12.5	TKE12.5	320	225	480	126	240	11	101
16	TKE16	320	245	480	146	240	11	112
20	TKE20	320	265	480	166	240	11	134
25	TKE25	320	295	480	186	240	11	161
31.5	TKE31.5	440	320	609	166	250	11	185
40	TKE40	440	340	679	186	250	11	213
50	TKE50	440	360	679	206	250	11	260

TKX IP00

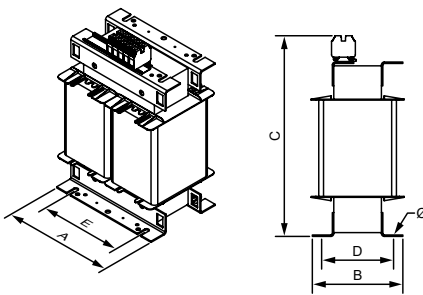

TKW IP23

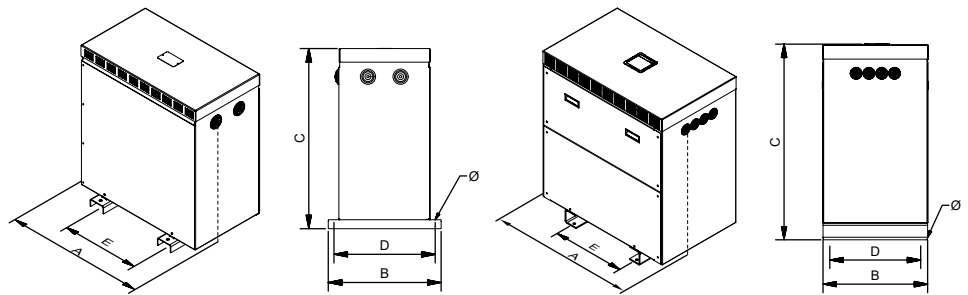

From 3.15 kVA to 25 kVA

From 31.5 kVA

TKZ IP54 / 65

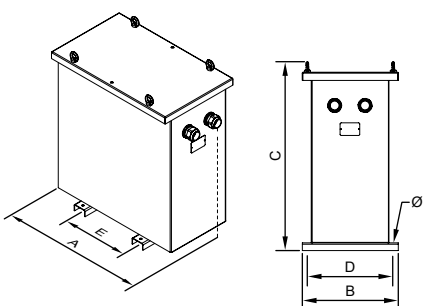

TKE IP20

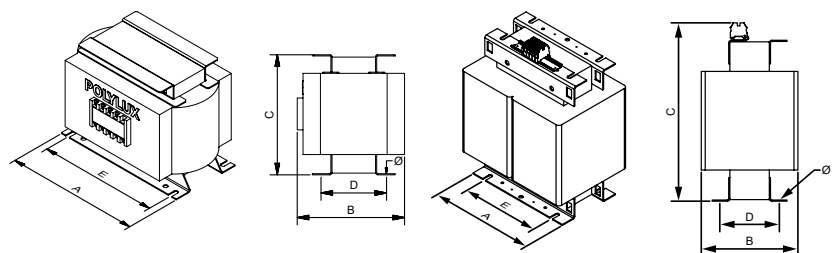

Up to 3.15 kVA

From 4 kVA





TK SERIES

Isolation · Input **230 V** · Output **230 V**

On-request manufacturing options (please see prices)

Power	From 3.15 kVA to 100 kVA
Windings	Copper or aluminium
Frequency	From 50 Hz to 400 Hz
IP rating	IP00, IP20, IP23, IP31, IP33, IP42, IP54, IP55 and IP65
IK rating	IK08 and IK10
Room temperature	Up to 60 °C
Locks	Screw, key
Test voltage	Up to 28 kV
Short circuit voltage	From 2% to 9%
Operation	Intermittent, continuous
Cooling	Natural, forced ventilation
Electrostatic shield	Up to three shields
Class	I, II
Altitude	Up to 4000 m
Protections	In both primary and secondary (figure 1)
Temperature sensors	PT100 (figure 2), PTC (figure 3) or bimetallic
Temperature control	Temperature control station (4xPT100) (figure 4), PTC thermal relays (3xPTC / 6xPTC)
Network analyser	(Figure 5)
Anti condensation system	Higrostat
Heating system	Heating elements
External protection	Anti-flash varnish, resin encapsulated, metal or stainless steel enclosure
Transportation and hoisting	Wheels (figure 6), lifting points
Paint	C3, C4, C5, different RAL
Feature plate	High generation polymer or stainless steel (figure 7)
Anti vibration system	Silentblock
Adjustment	-10%; -7.5%; -5%; -2.5%; +2.5%; +5%; +7.5%; +10% With bridges (figure 8) or selector (figure 9)
Certified	CE, DNV-GL, BV, UL (insulation) and POLYLUX laboratory
Climate class / environment / fire	Up to C2-E2-F1



Figure 1



Figure 2



Figure 3



Figure 4



Figure 5



Figure 6



Figure 7



Figure 8



Figure 9



TK SERIES

Isolation · Input 230 V · Output 230 V

Feature plate structure

Plastic label upto 25 kVA:

	POLYLUX®			CE declaration of conformity
Power (kVA)	XXX kVA		PRI: 230 V <small>XXX A</small>	Primary voltage
Reference	<small>TKXXXXX</small>		SEC: 230 V <small>XXX A</small>	Primary current
Frequency	50 - 60 Hz	F-155°C	IP-XX	Secondary voltage
Insulation transformer symbol		3kV	EN 61558	Secondary current
Serial number	SN: TKXXXXXXXXX <small>Made in Spain</small>			IP rating
			9 638 456 958 502	Applicable standard
				EAN bar code
				Test voltage
				Insulators

Stainless steel lable from 31.5 kVA:

	POLYLUX®		<small>www.polylux.com</small>	
Performance	XXX kVA		PRI: 230 V <small>XXX A</small>	Insulators
Short circuit voltage	<small>TKXXXXX</small>		SEC: 230 V <small>XXX A</small>	Test voltage
Power (kVA)	50 - 60 Hz	H-180°C	IEC 60076	Primary voltage
Frequency		3 kV	IP-XX	Primary current
Insulation transformer symbol		Pcc= XXX W	η = XX %	Secondary voltage
CE declaration of conformity		Po= XXX W	ANXX	Secondary current
Losses in short circuit	<small>Made in Spain</small>	Ucc= X %	XXXX kg	Applicable standard
Losses when empty		TKXXXXX		Protection rating
		SN: TKXXXXXXXXX		Cooling
				Weight
				Reference
				Serial number

Creating neutral

To perform this procedure: use a single-phase transformer with the appropriate power and connect it to primary with both phases and create a bridge at the output between one of the output phases and ground. This line will act as neutral from this moment.

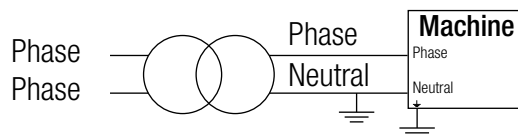



TK5IN SERIES

Isolation · Input 230 V · Output 230 V

Definition and applications

The TK5IN transformers are mainly used to isolate circuits and increase or reduce the output voltage if this is requested as a special assembly.

They are also used to change the installation neutral system for changing from a two-phase (PH + PH) to a single-phase network (PH + N) (this case means creating an artificial neutral) or vice versa.

In installations with a certain amount of electrical noise, the TK5IN series helps improve the electrical network quality in secondary.

For example: Supplying the electronics of equipment such as EV chargers, boilers, aérothermal or biomass equipment, which require the generation of grounded neutral to supply the equipment with Phase + Neutral.

Manufacturing characteristics

The TK5IN series are perfect for supplying continuous power to machinery residential installations or machinery. The transformers of this series are characterised by their low inrush (3 or 5In), low no-load losses >95%, quiet operation (noise level <40dB) and input protections with B or C and rated current curves).

Equipment with three different finishes based on sealing.

All the versions have the following features in common:

- Anti-flash dip varnishing. Ensures greater compactation, insulation and noise elimination <40dB.
- Welded copper connection end sleeves inserted into the terminal block to prevent hazards caused by expansion that leads to poor connection.
- All the transformers are checked automatically one by one and the compliance test report is created in accordance with the corresponding standard.



TK5INX

- IP00 protection rating.
- Power from 2 kVA to 40 kVA.
- Total impregnated in anti-flash varnish.
- Hoisting elements included.



TK5INW

- IP23 rating (IK08).
- Power from 2 kVA to 40 kVA.
- Metal box painted with RAL7035 polyester resin.
- High resistance to corrosion.
- Hoisting elements included.
- Detachable top and front cover.
- Cable outlet with cable gland.



TK5INZ

- IP54 rating / 65 (IK10).
- Power from 2 kVA to 40 kVA.
- Metal box painted with RAL7035 polyester resin.
- High resistance to corrosion.
- Hoisting elements included.
- Detachable top cover.
- Stuffing box cover for cable input depending on installation needs.
- With silentblock.



TK5IN SERIES

Isolation • Input 230 V • Output 230 V

Technical features - standard model

Power	2 kVA to 40 kVA
Standard voltage	Input 230 V // Output 230 V
Standard frequency	50-60 Hz
Noise	≤ 40 dB
Windings	Class HC-200 °C
Insulators	Class F - 155 °C ≤ 16 kVA (TK5INX, TK5INW)
	Class F - 155 °C ≤ 12,5 kVA (TK5INZ)
	Class H - 180 °C ≥ 20 kVA (TK5INX, TK5INW)
	Class H - 180 °C ≥ 16 kVA (TK5INZ)
	*More information in Technical Appendix (T.A.1)
Class	I
Altitude	1000 m
Enclosure colour	RAL 7035
IP rating	IP00 (TKX)
	IP23 (TKW)
	IP54 / 65 (TKZ)
IK rating	IK08 (TKW)
	IK10 (TKZ)
Paint class (ISO 12944)	C3 (TKW) C4 (TKZ)
Room temperature	45 °C
Standards	IEC/EN 61558, CE up to 16 kVA
	IEC/EN 60076, CE from 20 kVA
Test voltage	3 kV (1 min., 50 Hz)
Inrush	< 5 In
Ucc	≤ 4.7 %
K factor	4
Operation	Continuous
Cooling	AN (TKX / TKE) - ANAN (TKW / TKZ)
Hoisting accessories	Hoisting elements

Electrical diagram

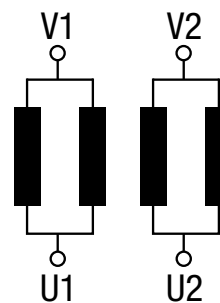

Connection

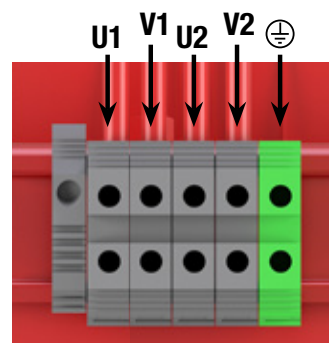

Terminal types

Terminals	External mm				Minimum conductor cross-section mm ²	Maximum tightening torque		TK5INX-TK5INW		TK5INZ	
	A	B	C	Ø		N-m	Lb-In	From	To	From	To
Terminal M5	15	18.5	14	M5	16	1.1	9.7	-	-	-	-
Power strip 1	Terminal 16	-	-	-	25	1.2	10.6	3.15	6.3	3.15	4
	Terminal 35	-	-	-	50	2.5	22.1	8	8	5	6.3
Power strip 2	Terminal 60	-	-	-	25	4.5	40	10	12.5	8	10
	Terminal 100	-	-	-	35	6.7	60	16	20	12.5	16
	Terminal 200	-	-	-	95	9	80	25	40	20	31.5
	Terminal 300	-	-	-	150	9	80	50	50	40	50

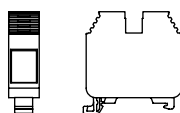
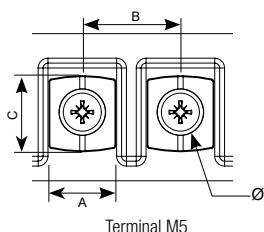

Power strip 1

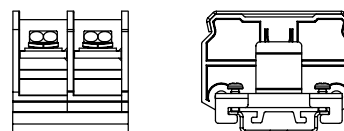

Power strip 2





TK5IN SERIES

Isolation · Input 230 V · Output 230 V

Theoretical data - standard model

Power kVA	Reference	Insulation class	Current A		Protections A		Cable gland (TKW) / Stuffing boxes (TKZ)	
			Input	Output	Input	Output	ø max. (mm)	Quantity
TK5INX								
2	TK5INX2	F	13,7	13,7	12 (C/gG)	12 (C/gG)	-	-
2,5	TK5INX2.5	F	13,7	13,7	12 (C/gG)	12 (C/gG)	-	-
3,15	TK5INX3.15	F	13,7	13,7	12 (C/gG)	12 (C/gG)	-	-
4	TK5INX4	F	17,4	17,4	16 (C/gG)	16 (C/gG)	-	-
5	TK5INX5	F	21,7	21,7	20 (C/gG)	20 (C/gG)	-	-
6,3	TK5INX6.3	F	27,4	27,4	25 (C/gG)	25 (C/gG)	-	-
8	TK5INX8	F	34,8	34,8	32 (C/gG)	32 (C/gG)	-	-
10	TK5INX10	F	43,5	43,5	40 (C/gG)	40 (C/gG)	-	-
12,5	TK5INX12.5	F	54,3	54,3	50 (C/gG)	50 (C/gG)	-	-
16	TK5INX16	F	69,6	69,6	63 (C/gG)	63 (C/gG)	-	-
20	TK5INX20	H	87,0	87,0	80 (C/gG)	80 (C/gG)	-	-
25	TK5INX25	H	108,7	108,7	100 (C/gG)	100 (C/gG)	-	-
31,5	TK5INX31.5	H	137,0	137,0	125 (C/gG)	125 (C/gG)	-	-
40	TK5INX40	H	173,9	173,9	160 (C/gG)	160 (C/gG)	-	-
TK5INW								
2	TK5INW2	F	13,7	13,7	12 (C/gG)	12 (C/gG)	18	2
2,5	TK5INW2.5	F	13,7	13,7	12 (C/gG)	12 (C/gG)	25	4
3,15	TK5INW3.15	F	13,7	13,7	12 (C/gG)	12 (C/gG)	25	4
4	TK5INW4	F	17,4	17,4	16 (C/gG)	16 (C/gG)	32	4
5	TK5INW5	F	21,7	21,7	20 (C/gG)	20 (C/gG)	32	4
6,3	TK5INW6.3	F	27,4	27,4	25 (C/gG)	25 (C/gG)	32	4
8	TK5INW8	F	34,8	34,8	32 (C/gG)	32 (C/gG)	32	4
10	TK5INW10	F	43,5	43,5	40 (C/gG)	40 (C/gG)	32	4
12,5	TK5INW12.5	F	54,3	54,3	50 (C/gG)	50 (C/gG)	32	4
16	TK5INW16	F	69,6	69,6	63 (C/gG)	63 (C/gG)	32	4
20	TK5INW20	H	87,0	87,0	80 (C/gG)	80 (C/gG)	32	8
25	TK5INW25	H	108,7	108,7	100 (C/gG)	100 (C/gG)	32	8
31,5	TK5INW31.5	H	137,0	137,0	125 (C/gG)	125 (C/gG)	32	8
40	TK5INW40	H	173,9	173,9	160 (C/gG)	160 (C/gG)	32	8
TK5INZ								
2	TK5INZ2	F	13,7	13,7	12 (C/gG)	12 (C/gG)	18 - 25	2
2,5	TK5INZ2.5	F	13,7	13,7	12 (C/gG)	12 (C/gG)	18 - 25	2
3,15	TK5INZ3.15	F	13,7	13,7	12 (C/gG)	12 (C/gG)	18 - 25	2
4	TK5INZ4	F	17,4	17,4	16 (C/gG)	16 (C/gG)	22 - 32	2
5	TK5INZ5	F	21,7	21,7	20 (C/gG)	20 (C/gG)	22 - 32	2
6,3	TK5INZ6.3	F	27,4	27,4	25 (C/gG)	25 (C/gG)	22 - 32	2
8	TK5INZ8	F	34,8	34,8	32 (C/gG)	32 (C/gG)	22 - 32	2
10	TK5INZ10	F	43,5	43,5	40 (C/gG)	40 (C/gG)	22 - 32	2
12,5	TK5INZ12.5	F	54,3	54,3	50 (C/gG)	50 (C/gG)	22 - 32	2
16	TK5INZ16	H	69,6	69,6	63 (C/gG)	63 (C/gG)	22 - 32	2
20	TK5INZ20	H	87,0	87,0	80 (C/gG)	80 (C/gG)	22 - 32	2
25	TK5INZ25	H	108,7	108,7	100 (C/gG)	100 (C/gG)	22 - 32	2
31,5	TK5INZ31.5	H	137,0	137,0	125 (C/gG)	125 (C/gG)	22 - 32	2
40	TK5INZ40	H	173,9	173,9	160 (C/gG)	160 (C/gG)	22 - 32	2



TK5IN SERIES

Isolation • Input 230 V • Output 230 V

Measurements

Power kVA	Dimensions mm							Weight kg
	Reference	A	B	C	D	E	Ø	
TKX								
2	TK5INX2	240	144	355	122	180	9	27,8
2,5	TK5INX2.5	240	164	355	142	180	11	35,1
3,15	TK5INX3.15	240	174	355	152	180	11	38,5
4	TK5INX4	280	170	419	126	210	11	41,0
5	TK5INX5	280	190	419	146	210	11	51,3
6,3	TK5INX6.3	280	210	419	166	210	11	61,4
8	TK5INX8	280	220	419	176	210	11	66,0
10	TK5INX10	320	260	480	154	240	11	68,1
12,5	TK5INX12.5	320	280	480	174	240	11	80,4
16	TK5INX16	320	300	480	194	240	11	94,7
20	TK5INX20	400	230	615	160	250	11	119
25	TK5INX25	400	250	615	180	250	11	146
31,5	TK5INX31.5	400	270	615	200	250	11	169
40	TK5INX40	400	280	615	210	250	11	185
TKW								
2	TK5INW2	458	340	500	300	300	12	32,8
2,5	TK5INW2.5	458	340	500	300	300	12	40,1
3,15	TK5INW3.15	458	340	500	300	300	12	43,5
4	TK5INW4	528	418	644	375	345	12	50,0
5	TK5INW5	528	418	644	375	345	12	60,3
6,3	TK5INW6.3	528	418	644	375	345	12	70,4
8	TK5INW8	528	418	644	375	345	12	75,0
10	TK5INW10	597	415	710	375	350	12	80,1
12,5	TK5INW12.5	597	415	710	375	350	12	92,4
16	TK5INW16	597	415	710	375	350	12	107
20	TK5INW20	795	550	970	500	415	12	135
25	TK5INW25	795	550	970	500	415	12	162
31,5	TK5INW31.5	795	550	970	500	415	12	185
40	TK5INW40	795	550	970	500	415	12	201

Power kVA	Dimensions mm							Weight kg
	Reference	A	B	C	D	E	Ø	
TKZ								
2	TK5INZ2	510	362	689	320	250	11	57,8
2,5	TK5INZ2.5	510	362	689	320	250	11	65,1
3,15	TK5INZ3.15	694	413	764	370	350	11	78,5
4	TK5INZ4	694	413	764	370	350	11	81,0
5	TK5INZ5	694	413	764	370	350	11	91,3
6,3	TK5INZ6.3	694	413	764	370	350	11	101
8	TK5INZ8	694	413	764	370	350	11	106
10	TK5INZ10	694	413	764	370	350	11	108
12,5	TK5INZ12.5	694	413	764	370	350	11	120
16	TK5INZ16	890	625	1148	500	426	12	155
20	TK5INZ20	890	625	1148	500	426	12	179
25	TK5INZ25	890	625	1148	500	426	12	206
31,5	TK5INZ31.5	890	625	1148	500	426	12	229
40	TK5INZ40	890	625	1148	500	426	12	245

TK5INX IP00

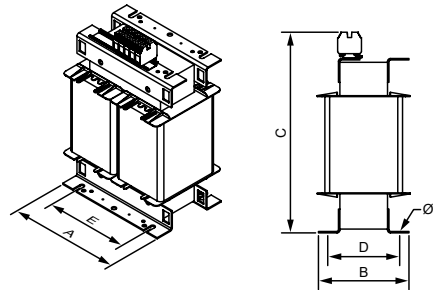

TK5INW IP23

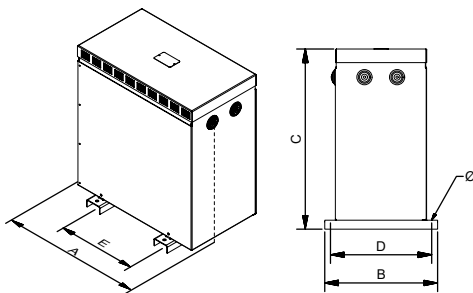

From 2 kVA up to 16 kVA

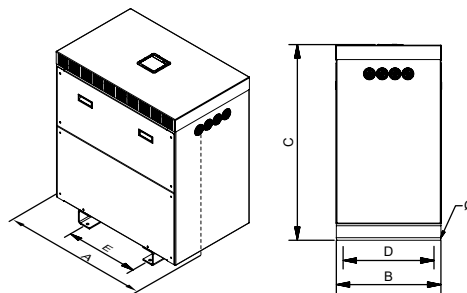

From 20 kVA



Seccionado

TK5INZ IP54 / 65

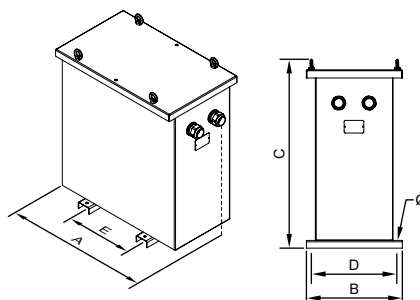



TK5IN SERIES

Isolation · Input **230 V** · Output **230 V**

On-request manufacturing options (please see prices)

Power	From 2 kVA to 100 kVA
Windings	Copper or aluminium
Frequency	From 50 Hz to 400 Hz
IP rating	IP00, IP20, IP23, IP31, IP33, IP42, IP54, IP55 and IP65
IK rating	IK08 and IK10
Room temperature	Up to 60 °C
Locks	Screw, key
Test voltage	Up to 28 kV
Short circuit voltage	From 2% to 9%
Operation	Intermittent, continuous
Cooling	Natural, forced ventilation
Electrostatic shield	Up to three shields
Class	I, II
Altitude	Up to 4000 m
Protections	In both primary and secondary (figure 1)
Temperature sensors	PT100 (figure 2), PTC (figure 3) or bimetallic
Temperature control	Temperature control station (4xPT100) (figure 4), PTC thermal relays (3xPTC / 6xPTC)
Network analyser	(Figure 5)
Anti condensation system	Higrostat
Heating system	Heating elements
External protection	Anti-flash varnish, resin encapsulated, metal or stainless steel enclosure
Transportation and hoisting	Wheels (figure 6), lifting points
Paint	C3, C4, C5, different RAL
Feature plate	High generation polymer or stainless steel (figure 7)
Anti vibration system	Silentblock
Adjustment	-10%; -7.5%; -5%; -2.5%; +2.5%; +5%; +7.5%; +10% With bridges (figure 8) or selector (figure 9)
Certified	CE, DNV-GL, BV, UL (insulation) and POLYLUX laboratory
Climate class / environment / fire	Up to C2-E2-F1



Figure 1



Figure 2



Figure 3



Figure 4



Figure 5



Figure 6



Figure 7



Figure 8



Figure 9



TK5IN SERIES

Isolation • Input 230 V • Output 230 V

Feature plate structure

Plastic label upto 25 kVA:

POLYLUX		CE		CE declaration of conformity
Power (kVA)	XXX kVA <small>TKXXXX</small>	PRI:	230 V <small>XXX A</small>	Primary voltage
Reference		SEC:	230 V <small>XXX A</small>	Primary current
Frequency				Secondary voltage
				Secondary current
				IP rating
Insulation transformer symbol		50 - 60 Hz	F-155°C	Applicable standard
			3kV	EN 61558
				EAN bar code
Serial number	SN: TKXXXXXXXXX Made in Spain			Test voltage
				Insulators

Stainless steel lable from 31.5 kVA:

POLYLUX		www.polylux.com		Insulators
Performance		PRI:	230 V <small>XXX A</small>	Test voltage
Short circuit voltage		SEC:	230 V <small>XXX A</small>	Primary voltage
Power (kVA)	XXX kVA			Primary current
Frequency				Secondary voltage
				Secondary current
Insulation transformer symbol		50 - 60 Hz	H-180°C	Applicable standard
			3 kV	IP-XX
				Protection rating
CE declaration of conformity	CE	Pcc= XXX W	η = XX %	Cooling
	Made in Spain	Po= XXX W	Ucc= X %	ANXX
Losses in short circuit				Weight
Losses when empty				XXXX kg
				Reference
			TKXXXXX	Serial number
			SN: TKXXXXXXXXX	

Creating neutral

To perform this procedure: use a single-phase transformer with the appropriate power and connect it to primary with both phases and create a bridge at the output between one of the output phases and ground. This line will act as neutral from this moment.

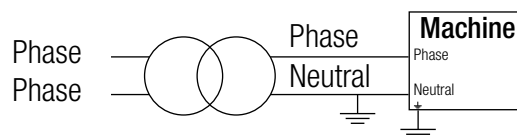



TT SERIES

Isolation · Input **400 V** · Output **400 V +N**

Definition and applications

Our TT series are three-phase isolation transformers designed for continuous operation at maximum output 365 days a year. This guarantees power is supplied to the installations or equipment they supply.

Applications:

- The main application of the TT transformers is the isolation of circuits, with the possibility of increasing or reducing the voltage.
- Reducing voltage drops in installations with long cable lengths. With the installation of a step-up transformer and a reducer transformer.
- In installations with a certain level of electrical noise, the TT series helps improve the electrical network quality in secondary.
- Changing the neutral system of an installation.

Manufacturing characteristics

- All the transformers are dipped in anti-flash varnish and then compacted in the furnace. This process increases the insulation grade, reduces noise and provides anti-moisture, waterproofed protection.
- The high power transformers are manufactured with format cores and low loss properties, thus contributing to improving performance.
- All the transformers are checked automatically one by one and the compliance test report is created in accordance with the corresponding standard.

Recommendation for selecting the best transformer in terms of use and installation location

Main compliance properties based on model	Considerations		
	Encapsulated in resin	IP00 Air	Oil
Non-flammable	✓	✗	✗
Self-extinguishing.	✓	✗	✗
No safety measures against the risk of explosion	✓	✓	✗
No special installation conditions	✓	✓	✗
Protected against damp, saline and corrosive environments	✓	✗	✓
Greater resistance to overload and transient harmonics	✓	✗	✗
No maintenance	✓	✓	✗
No risk of contamination	✓	✓	✗

- The IP00 (air) can be installed in control cabinets with all the necessary protections and in dry places, which is more economical.
- Both models (encapsulated and IP00) can be protected with metallic enclosures up to IP65.
- In addition, the **ECOLOGICAL** transformer can be manufactured in both models, with different properties such as lower consumption, thus achieving fast amortisation.
- The transformer with the best properties is the transformer encapsulated in fire retardant resin.



TTX

- IP00 protection rating.
- Power from 0.63 kVA to 1000 kVA.
- Total impregnated in anti-flash varnish.
- Hoisting elements included.



TTW

- IP23 rating (IK08).
- Power from 0.63 kVA to 1000 kVA.
- Metal box painted with RAL7035 polyester resin.
- High resistance to corrosion.
- Hoisting elements included.
- Detachable top and front cover.
- Cable outlet with cable gland.



TTZ

- IP54 rating / 65 (IK10).
- Power from 0.63 kVA to 1000 kVA.
- Metal box painted with RAL7035 polyester resin.
- High resistance to corrosion.
- Hoisting elements included.
- Detachable top cover.
- Stuffing box cover for cable input depending on installation needs.
- With silentblock.



TTE

- **Encapsulated in flame retardant resin.**
- IP20 protection rating.
- Power from 0.40 kVA to 400 kVA.
- Protection against damp, saline and corrosive environments.
- Greater resistance to surge currents.
- Greater resistance to transient harmonics.
- Greater mechanical resistance to undesirable vibrations.
- Uniform heat dissipation.
- Hoisting elements included.



TT SERIES

Isolation · Input **400 V** · Output **400 V + N**

Technical features - standard model

Standard voltage	Input 400 V // Output 400 V and N.
Standard frequency	50-60 Hz
Connection unit	Yyn0
Windings	Class HC-200 °C
Insulators	Class F - 155 °C ≤ 31.5 kVA (25 kVA TTZ) Class H - 180 °C ≥ 40 kVA (31.5 kVA TTZ) <small>*More information in Technical Appendix (T.A.1)</small>
Safety class	I
Altitude	1000 m
Enclosure colour	RAL 7035
IP rating	IP00 (TTX) IP20 (TTE) IP23 (TTW) IP54 / 65 (TTZ)
IK rating	IK08 (TTW) IK10 (TTZ)
Paint class (ISO 12944)	C3 (TTW) C4 (TTZ)
Room temperature	45 °C
Standards	IEC/EN 61558, CE up to 31.5 kVA IEC/EN 60076, CE from 40 kVA
Test voltage	3 kV (1 min., 50 Hz)
Inrush	< 12 In
Ucc	≤ 4 %
K factor	4
Operation	Continuous
Cooling	AN (TTX / TTE) - ANAN (TTW / TTZ)
Hoisting accessories	Hoisting elements included.

Electrical diagram

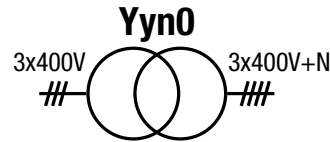
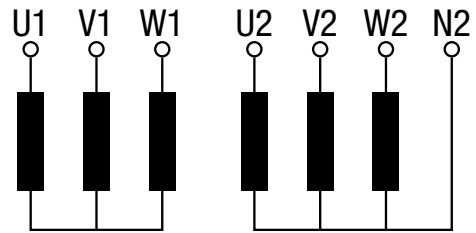

Connection

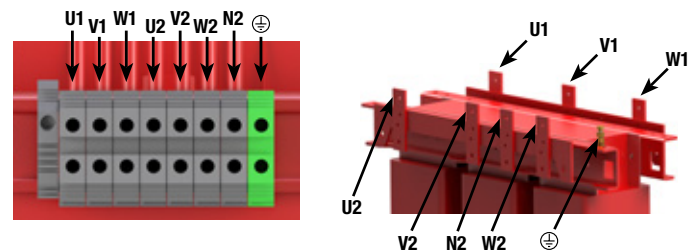

Terminal types

Terminals	External mm				Maximum cross-section conductor mm ²	Maximum tightening torque		TTX-TTW Power kVA		TTE Power kVA		TTZ Power kVA	
	A	B	C	Ø		N·m	Lb·In	From	To	From	To	From	To
Terminal M5	15	18.5	14	M5	-	1.1	9.7	-	-	0.4	5	-	-
Power strip 1	Terminal 4	-	-	-	6	0.5	4.4	0.63	2	-	-	0.63	1
	Terminal 10	-	-	-	16	1.2	10.6	2.5	6.3	6.3	6.3	2	5
	Terminal 16	-	-	-	25	1.2	10.6	8	12.5	8	12.5	6.3	10
Power strip 2	Terminal 60	-	-	-	25	4.5	40	16	40	16	40	12.5	40
	Terminal 100	-	-	-	35	6.7	60	50	63	50	63	50	63
	Terminal 200	-	-	-	95	9	80	80	125	80	125	80	125
	Terminal 300	-	-	-	150	9	80	160	200	160	200	160	200
Connection plate	Plate 50 X 1	-	-	-	150	-	-	250	400	250	400	250	400
	Plate 100 X 4	-	-	-	150	-	-	500	1000	500	1000	500	1000

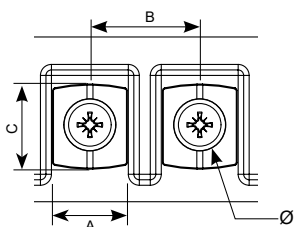

Terminal M5

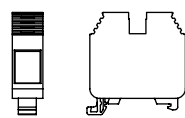

Power strip 1

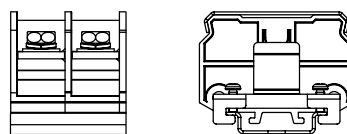

Power strip 2

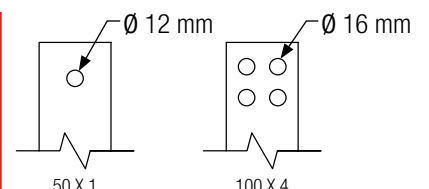

Plate connection



TT SERIES

Isolation · Input 400 V · Output 400 V + N

Theoretical data - standard model

Power kVA	Reference	Insulation class	Current A		Protections A		Noise dB	Cable gland	
			Input	Output	Input	Output		ø max. (mm)	Quantity
TTX									
0.63	TTX0.63	F	0.9	0.9	2 (D/aM)	1 (C/gG)	≤45	-	-
1	TTX1	F	1.4	1.4	3 (D/aM)	1.6 (C/gG)	≤45	-	-
2	TTX2	F	2.9	2.9	6 (D/aM)	3 (C/gG)	≤45	-	-
2.5	TTX2.5	F	3.6	3.6	6 (D/aM)	3 (C/gG)	≤45	-	-
3.15	TTX3.15	F	4.6	4.6	10 (D/aM)	4 (C/gG)	≤45	-	-
4	TTX4	F	5.8	5.8	10 (D/aM)	5 (C/gG)	≤45	-	-
5	TTX5	F	7.2	7.2	16 (D/aM)	6 (C/gG)	≤45	-	-
6.3	TTX6.3	F	9.1	9.1	20 (D/aM)	10 (C/gG)	≤45	-	-
8	TTX8	F	11.6	11.6	25 (D/aM)	12 (C/gG)	≤45	-	-
10	TTX10	F	14.5	14.5	32 (D/aM)	16 (C/gG)	≤45	-	-
12.5	TTX12.5	F	18.1	18.1	32 (D/aM)	16 (C/gG)	≤45	-	-
16	TTX16	F	23.1	23.1	40 (D/aM)	20 (C/gG)	≤45	-	-
20	TTX20	F	28.9	28.9	50 (D/aM)	25 (C/gG)	≤45	-	-
25	TTX25	F	36.1	36.1	63 (D/aM)	32 (C/gG)	≤45	-	-
31.5	TTX31.5	F	45.5	45.5	80 (D/aM)	40 (C/gG)	≤45	-	-
40	TTX40	H	57.8	57.8	100 (D/aM)	50 (C/gG)	≤55	-	-
50	TTX50	H	72.3	72.3	125 (D/aM)	63 (C/gG)	≤55	-	-
63	TTX63	H	91	91	160 (D/aM)	80 (C/gG)	≤55	-	-
80	TTX80	H	116	116	200 (D/aM)	100 (C/gG)	≤55	-	-
100	TTX100	H	145	145	250 (D/aM)	125 (C/gG)	≤55	-	-
125	TTX125	H	181	181	400 (D/aM)	160 (C/gG)	≤55	-	-
160	TTX160	H	231	231	500 (D/aM)	200 (C/gG)	≤55	-	-
200	TTX200	H	289	289	630 (D/aM)	250 (C/gG)	≤55	-	-
250	TTX250	H	361	361	800 (D/aM)	300 (C/gG)	≤65	-	-
315	TTX315	H	455	455	1000 (-/aM)	400 (C/gG)	≤65	-	-
400	TTX400	H	578	578	1250 (-/aM)	500 (C/gG)	≤65	-	-
500	TTX500	H	723	723	1500 (-/aM)	630 (C/gG)	≤65	-	-
630	TTX630	H	910	910	2000 (-/aM)	800 (C/gG)	≤65	-	-
800	TTX800	H	1156	1156	2500 (-/aM)	1000 (C/gG)	≤65	-	-
1000	TTX1000	H	1445	1445	3000 (-/aM)	1250 (C/gG)	≤65	-	-
TTW									
0.63	TTW0.63	F	0.9	0.9	2 (D/aM)	1 (C/gG)	≤45	14	2
1	TTW1	F	1.4	1.4	3 (D/aM)	1.6 (C/gG)	≤45	14	2
2	TTW2	F	2.9	2.9	6 (D/aM)	3 (C/gG)	≤45	14	2
2.5	TTW2.5	F	3.6	3.6	6 (D/aM)	3 (C/gG)	≤45	18	2
3.15	TTW3.15	F	4.6	4.6	10 (D/aM)	4 (C/gG)	≤45	18	2
4	TTW4	F	5.8	5.8	10 (D/aM)	5 (C/gG)	≤45	18	2
5	TTW5	F	7.2	7.2	16 (D/aM)	6 (C/gG)	≤45	18	2
6.3	TTW6.3	F	9.1	9.1	20 (D/aM)	10 (C/gG)	≤45	25	4
8	TTW8	F	11.6	11.6	25 (D/aM)	12 (C/gG)	≤45	25	4
10	TTW10	F	14.5	14.5	32 (D/aM)	16 (C/gG)	≤45	32	4
12.5	TTW12.5	F	18.1	18.1	32 (D/aM)	16 (C/gG)	≤45	32	4
16	TTW16	F	23.1	23.1	40 (D/aM)	20 (C/gG)	≤45	32	4
20	TTW20	F	28.9	28.9	50 (D/aM)	25 (C/gG)	≤45	32	4
25	TTW25	F	36.1	36.1	63 (D/aM)	32 (C/gG)	≤45	32	4
31.5	TTW31.5	F	45.5	45.5	80 (D/aM)	40 (C/gG)	≤45	32	4
40	TTW40	H	57.8	57.8	100 (D/aM)	50 (C/gG)	≤55	32	8
50	TTW50	H	72.3	72.3	125 (D/aM)	63 (C/gG)	≤55	32	8
63	TTW63	H	91	91	160 (D/aM)	80 (C/gG)	≤55	32	8
80	TTW80	H	116	116	200 (D/aM)	100 (C/gG)	≤55	32	8
100	TTW100	H	145	145	250 (D/aM)	125 (C/gG)	≤55	32	8
125	TTW125	H	181	181	400 (D/aM)	160 (C/gG)	≤55	44	8
160	TTW160	H	231	231	500 (D/aM)	200 (C/gG)	≤55	44	8
200	TTW200	H	289	289	630 (D/aM)	250 (C/gG)	≤55	44	8
250	TTW250	H	361	361	800 (D/aM)	300 (C/gG)	≤65	44	8
315	TTW315	H	455	455	1000 (-/aM)	400 (C/gG)	≤65	44	8
400	TTW400	H	578	578	1250 (-/aM)	500 (C/gG)	≤65	44	8
500	TTW500	H	723	723	1500 (-/aM)	630 (C/gG)	≤65	44	8
630	TTW630	H	910	910	2000 (-/aM)	800 (C/gG)	≤65	44	8
800	TTW800	H	1156	1156	2500 (-/aM)	1000 (C/gG)	≤65	44	8
1000	TTW1000	H	1445	1445	3000 (-/aM)	1250 (C/gG)	≤65	44	8



TT SERIES

Isolation · Input 400 V · Output 400 V + N

Theoretical data - standard model

Power kVA	Reference	Insulation class	Current A		Protections A		Noise dB	Stuffing boxes	
			Input	Output	Input	Output		∅ (mm)	Quantity
TTZ									
0.63	TTZ0.63	F	0.9	0.9	2 (D/aM)	1 (C/gG)	≤45	10 - 14	2
1	TTZ1	F	1.4	1.4	3 (D/aM)	1.6 (C/gG)	≤45	10 - 14	2
2	TTZ2	F	2.9	2.9	6 (D/aM)	3 (C/gG)	≤45	10 - 14	2
2.5	TTZ2.5	F	3.6	3.6	6 (D/aM)	3 (C/gG)	≤45	18 - 25	2
3.15	TTZ3.15	F	4.6	4.6	10 (D/aM)	4 (C/gG)	≤45	18 - 25	2
4	TTZ4	F	5.8	5.8	10 (D/aM)	5 (C/gG)	≤45	18 - 25	2
5	TTZ5	F	7.2	7.2	16 (D/aM)	6 (C/gG)	≤45	18 - 25	2
6.3	TTZ6.3	F	9.1	9.1	20 (D/aM)	10 (C/gG)	≤45	18 - 25	2
8	TTZ8	F	11.6	11.6	25 (D/aM)	12 (C/gG)	≤45	18 - 25	2
10	TTZ10	F	14.5	14.5	32 (D/aM)	16 (C/gG)	≤45	22 - 32	2
12.5	TTZ12.5	F	18.1	18.1	32 (D/aM)	16 (C/gG)	≤45	22 - 32	2
16	TTZ16	F	23.1	23.1	40 (D/aM)	20 (C/gG)	≤45	22 - 32	2
20	TTZ20	F	28.9	28.9	50 (D/aM)	25 (C/gG)	≤45	22 - 32	2
25	TTZ25	F	36.1	36.1	63 (D/aM)	32 (C/gG)	≤45	22 - 32	2
31.5	TTZ31.5	F	45.5	45.5	80 (D/aM)	40 (C/gG)	≤45	22 - 32	2
40	TTZ40	H	57.8	57.8	100 (D/aM)	50 (C/gG)	≤55	22 - 32	2
50	TTZ50	H	72.3	72.3	125 (D/aM)	63 (C/gG)	≤55	22 - 32	2
63	TTZ63	H	91	91	160 (D/aM)	80 (C/gG)	≤55	22 - 32	2
80	TTZ80	H	116	116	200 (D/aM)	100 (C/gG)	≤55	22 - 32	2
100	TTZ100	H	145	145	250 (D/aM)	125 (C/gG)	≤55	22 - 32	2
125	TTZ125	H	181	181	400 (D/aM)	160 (C/gG)	≤55	34 - 44	2
160	TTZ160	H	231	231	500 (D/aM)	200 (C/gG)	≤55	34 - 44	2
200	TTZ200	H	289	289	630 (D/aM)	250 (C/gG)	≤55	34 - 44	2
250	TTZ250	H	361	361	800 (D/aM)	300 (C/gG)	≤65	34 - 44	2
315	TTZ315	H	455	455	1000 (--/aM)	400 (C/gG)	≤65	34 - 44	2
400	TTZ400	H	578	578	1250 (--/aM)	500 (C/gG)	≤65	34 - 44	2
500	TTZ500	H	723	723	1500 (--/aM)	630 (C/gG)	≤65	34 - 44	2
630	TTZ630	H	910	910	2000 (--/aM)	800 (C/gG)	≤65	34 - 44	2
800	TTZ800	H	1156	1156	2500 (--/aM)	1000 (C/gG)	≤65	34 - 44	2
1000	TTZ1000	H	1445	1445	3000 (--/aM)	1250 (C/gG)	≤65	34 - 44	2
TTE									
0.4	TTE0.4	F	0.6	0.6	2 (D/aM)	1 (C/gG)	≤45	-	-
0.63	TTE0.63	F	0.9	0.9	2 (D/aM)	1 (C/gG)	≤45	-	-
1	TTE1	F	1.4	1.4	3 (D/aM)	1.6 (C/gG)	≤45	-	-
1.6	TTE1.6	F	2.3	2.3	6 (D/aM)	2 (C/gG)	≤45	-	-
2	TTE2	F	2.9	2.9	6 (D/aM)	3 (C/gG)	≤45	-	-
2.5	TTE2.5	F	3.6	3.6	6 (D/aM)	3 (C/gG)	≤45	-	-
3.15	TTE3.15	F	4.6	4.6	10 (D/aM)	4 (C/gG)	≤45	-	-
4	TTE4	F	5.8	5.8	10 (D/aM)	5 (C/gG)	≤45	-	-
5	TTE5	F	7.2	7.2	16 (D/aM)	6 (C/gG)	≤45	-	-
6.3	TTE6.3	F	9.1	9.1	20 (D/aM)	10 (C/gG)	≤45	-	-
8	TTE8	F	11.6	11.6	25 (D/aM)	12 (C/gG)	≤45	-	-
10	TTE10	F	14.5	14.5	32 (D/aM)	16 (C/gG)	≤45	-	-
12.5	TTE12.5	F	18.1	18.1	32 (D/aM)	16 (C/gG)	≤45	-	-
16	TTE16	F	23.1	23.1	40 (D/aM)	20 (C/gG)	≤45	-	-
20	TTE20	F	28.9	28.9	50 (D/aM)	25 (C/gG)	≤45	-	-
25	TTE25	F	36.1	36.1	63 (D/aM)	32 (C/gG)	≤45	-	-
31.5	TTE31.5	F	45.5	45.5	80 (D/aM)	40 (C/gG)	≤45	-	-
40	TTE40	H	57.8	57.8	100 (D/aM)	50 (C/gG)	≤55	-	-
50	TTE50	H	72.3	72.3	125 (D/aM)	63 (C/gG)	≤55	-	-
63	TTE63	H	91	91	160 (D/aM)	80 (C/gG)	≤55	-	-
80	TTE80	H	116	116	200 (D/aM)	100 (C/gG)	≤55	-	-
100	TTE100	H	145	145	250 (D/aM)	125 (C/gG)	≤55	-	-
125	TTE125	H	181	181	400 (D/aM)	160 (C/gG)	≤55	-	-
160	TTE160	H	231	231	500 (D/aM)	200 (C/gG)	≤55	-	-
200	TTE200	H	289	289	630 (D/aM)	250 (C/gG)	≤55	-	-
250	TTE250	H	361	361	800 (D/aM)	300 (C/gG)	≤65	-	-
315	TTE315	H	455	455	1000 (--/aM)	400 (C/gG)	≤65	-	-
400	TTE400	H	578	578	1250 (--/aM)	500 (C/gG)	≤65	-	-





TT SERIES

Isolation · Input 400 V · Output 400 V + N

Measurements

Power kVA	Reference	External dimensions mm			Fastening elements mm			Weight kg
		A	B	C	D	E	Ø	
TTX								
0.63	TTX0.63	150	94	178	66	125	6	5.9
1	TTX1	180	94	203	76	150	6	9.5
2	TTX2	240	118	253	119	200	9	20
2.5	TTX2.5	300	124	303	115	250	9	23.9
3.15	TTX3.15	300	134	303	125	250	9	27.4
4	TTX4	300	154	303	145	250	9	36
5	TTX5	300	164	303	155	250	9	40.4
6.3	TTX6.3	360	144	353	122	300	11	55
8	TTX8	360	164	353	142	300	11	67
10	TTX10	420	170	419	136	350	11	78
12.5	TTX12.5	420	190	419	156	350	11	94
16	TTX16	480	250	480	144	400	11	105
20	TTX20	480	270	480	164	400	11	125
25	TTX25	480	290	480	184	400	11	145
31.5	TTX31.5	480	310	480	204	400	11	162
40	TTX40	670	280	615	170	426	13	191
50	TTX50	670	300	615	190	426	13	233
63	TTX63	670	320	690	210	426	13	277
80	TTX80	670	340	690	230	426	13	320
100	TTX100	670	360	690	250	426	13	368
125	TTX125	785	550	880	460	472	17	462
160	TTX160	785	550	880	460	472	17	560
200	TTX200	785	550	880	460	472	17	660
250	TTX250	1016	550	1080	460	690	17	808
315	TTX315	1070	550	1220	460	690	17	1000
400	TTX400	1070	550	1220	460	690	17	1092
500	TTX500	1300	550	1350	460	800	17	1658
630	TTX630	1300	600	1350	460	800	17	2000
800	TTX800	1300	700	1350	600	800	17	2413
1000	TTX1000	1300	800	1350	600	800	17	2993

Power kVA	Reference	External dimensions mm			Fastening elements mm			Weight kg
		A	B	C	D	E	Ø	
TTW								
0.63	TTW0.63	194	175	220	165	100	6	7.6
1	TTW1	240	190	250	180	150	6	13.2
2	TTW2	315	230	315	205	200	6	24.8
2.5	TTW2.5	385	260	384	245	250	6	28.8
3.15	TTW3.15	385	260	384	245	250	6	32.8
4	TTW4	385	260	384	245	250	6	40.8
5	TTW5	385	260	384	245	250	6	45.2
6.3	TTW6.3	458	340	500	300	300	12	61
8	TTW8	458	340	500	300	300	12	73
10	TTW10	528	418	644	375	345	12	89
12.5	TTW12.5	528	418	644	375	345	12	106
16	TTW16	597	415	710	375	345	12	117
20	TTW20	597	415	710	375	345	12	137
25	TTW25	597	415	710	375	345	12	157
31.5	TTW31.5	597	415	710	375	345	12	174
40	TTW40	795	550	970	500	415	12	237
50	TTW50	795	550	970	500	415	12	279
63	TTW63	795	550	970	500	415	12	323
80	TTW80	795	550	970	500	415	12	366
100	TTW100	795	550	970	500	415	12	414
125	TTW125	970	670	1250	582	470	18	514
160	TTW160	970	670	1250	582	470	18	612
200	TTW200	970	670	1250	582	470	18	754
250	TTW250	1200	760	1555	672	690	18	855
315	TTW315	1200	760	1555	672	690	18	1093
400	TTW400	1200	760	1555	672	690	18	1185
500	TTW500	1530	1000	1880	900	800	20	1808
630	TTW630	1530	1000	1880	900	800	20	2149
800	TTW800	1530	1000	1880	900	800	20	2563
1000	TTW1000	1530	1000	1880	900	800	20	3143

TTX IP00

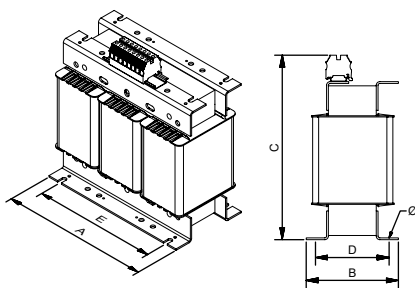

From 0.63 kVA to 12.5 kVA

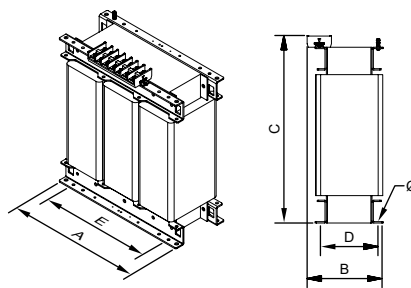

From 16 kVA to 200 kVA

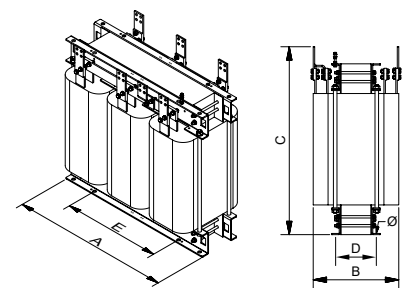

From 250 kVA

TTW IP23

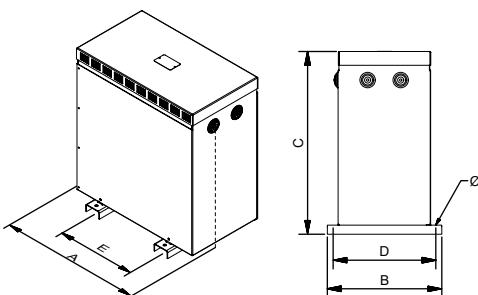

From 0.63 kVA to 31.5 kVA

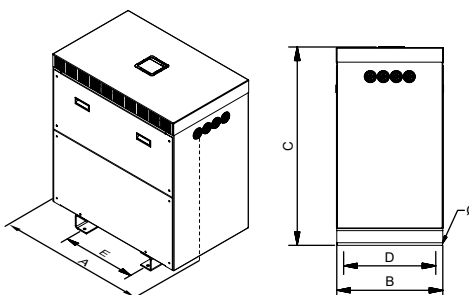

From 40 kVA



Sectioned



TT SERIES

Isolation · Input 400 V · Output 400 V + N

Measurements

Power kVA	Reference	External dimensions mm			Fastening elements mm			Weight kg
		A	B	C	D	E	∅	
TTZ								
0.63	TTZ0.63	330	284	463	230	200	11	19.5
1	TTZ1	330	284	463	230	200	11	24
2	TTZ2	510	362	689	320	250	11	37
2.5	TTZ2.5	510	362	689	320	250	11	40
3.15	TTZ3.15	510	362	689	320	250	11	57
4	TTZ4	510	362	689	320	250	11	61
5	TTZ5	510	362	689	320	250	11	76
6.3	TTZ6.3	510	362	689	320	250	11	87.5
8	TTZ8	694	413	764	370	350	11	118
10	TTZ10	694	413	764	370	350	11	134
12.5	TTZ12.5	694	413	764	370	350	11	145
16	TTZ16	694	413	764	370	350	11	165
20	TTZ20	694	413	764	370	350	11	185
25	TTZ25	694	413	764	370	350	11	202
31.5	TTZ31.5	694	413	764	370	350	11	220
40	TTZ40	890	560	1148	520	426	13	251
50	TTZ50	890	560	1148	520	426	13	295
63	TTZ63	890	560	1148	520	426	13	340
80	TTZ80	890	560	1148	520	426	13	383
100	TTZ100	890	560	1148	520	426	13	433
125	TTZ125	972	740	1480	660	470	17	551
160	TTZ160	972	740	1480	660	470	17	628
200	TTZ200	972	740	1480	660	470	17	797
250	TTZ250	1394	870	1762	810	690	17	1186
315	TTZ315	1394	870	1762	810	690	17	1278
400	TTZ400	1394	870	1762	810	690	17	1933
500	TTZ500	1640	1226	1770	1110	800	17	2275
630	TTZ630	1640	1226	1770	1110	800	17	2688
800	TTZ800	1640	1226	1770	1110	800	17	3268
1000	TTZ1000	1640	1226	1770	1110	800	17	3848

Power kVA	Reference	External dimensions mm			Fastening elements mm			Weight kg
		A	B	C	D	E	∅	
TTE								
0.4	TTE0.4	175	165	145	145	126	4	7.5
0.63	TTE0.63	175	165	160	145	126	4	9.2
1	TTE1	210	198	175	177	174	4	15.4
1.6	TTE1.6	280	158	205	100	250	9	24
2	TTE2	280	158	205	115	250	9	26.6
2.5	TTE2.5	340	160	255	310	96	9	32.7
3.15	TTE3.15	340	160	255	310	106	9	35.8
4	TTE4	340	200	255	310	126	9	47.3
5	TTE5	340	205	255	310	136	9	51
6.3	TTE6.3	378	158	353	122	300	11	69
8	TTE8	378	178	353	142	300	11	85
10	TTE10	448	202	419	142	350	11	111
12.5	TTE12.5	448	222	419	162	350	11	129
16	TTE16	510	225	480	126	400	11	146
20	TTE20	510	245	480	146	400	11	167
25	TTE25	510	265	480	166	400	11	189
31.5	TTE31.5	510	295	480	186	400	11	208
40	TTE40	670	320	608.5	166	426	11	254
50	TTE50	670	340	678.5	186	426	11	318
63	TTE63	670	360	678.5	206	426	11	420
80	TTE80	750	550	898	460	472	13	478
100	TTE100	750	550	898	460	472	13	546
125	TTE125	750	550	898	460	472	13	603
160	TTE160	750	550	898	460	472	13	720
200	TTE200	1016	550	1065	460	690	13	1093
250	TTE250	1016	550	1065	460	690	13	1225
315	TTE315	1083	550	1205	460	690	13	1429
400	TTE400	1083	550	1205	460	690	13	1619

TTZ IP54 / 65

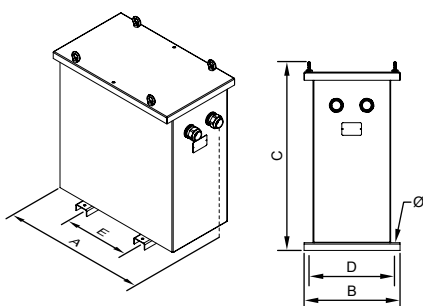

TTE IP20

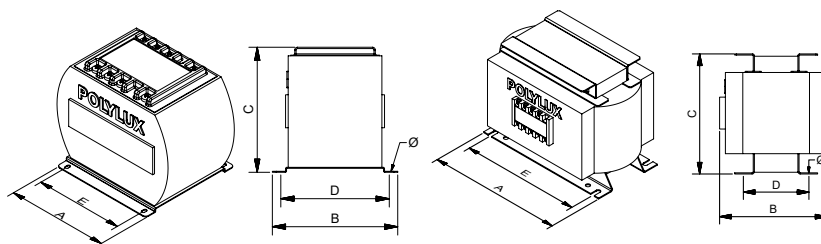

From 0.4 kVA to 1 kVA

From 1.6 kVA to 5 kVA

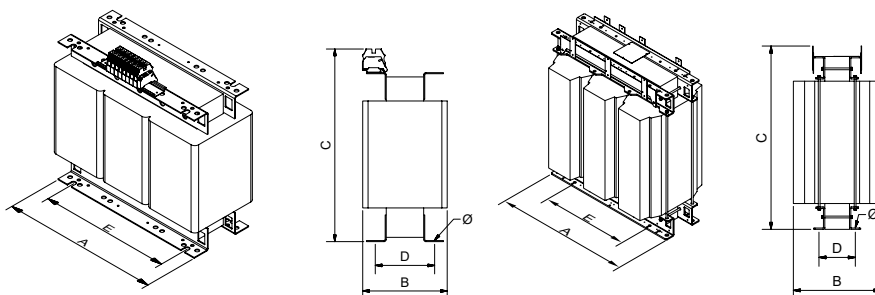

From 6.3 kVA to 31.5 kVA

From 40 kVA



TT SERIES

Isolation · Input **400 V** · Output **400 V + N**

On-request manufacturing options (please see prices)

Power	From 0.15 kVA to 1000 kVA
Voltage	From 1 V to 12 kV
Windings	Copper or aluminium
Frequency	From 50 Hz to 400 Hz
Connection unit	Yyn0, Dyn11, Dd0, Dy1, Dyn5, YNd1/5/11... (See Technical Appendix T.A.2)
IP rating	IP00, IP20, IP23, IP31, IP42, IP54, IP55 and IP65
IK rating	IK08 and IK10
Room temperature	Up to 60 °C
Locks	Screw, key
Test voltage	Up to 28 kV
Short circuit voltage	From 2% to 9%
Losses	Low losses, ecological
Operation	Intermittent, continuous
Cooling	Natural, forced ventilation
Electrostatic shield	Up to three shields
Safety class	I, II
Altitude	Up to 4000 m
Protections	In both primary and secondary (figure 1)
Temperature sensors	PT100 (figure 2), PTC (figure 3) or bimetallic
Temperature control	Temperature control station (4xPT100) (figure 4), PTC thermal relays (3xPTC / 6xPTC)
Network analyser	(Figure 5)
Anti condensation system	Higrostat
Heating system	Heating elements
External protection	Anti-flash varnish, resin encapsulated, metal or stainless steel enclosure
Transportation and hoisting	Wheels (figure 6), lifting points
Paint	C3, C4, C5, different RAL
Feature plate	High generation polymer or stainless steel (figure 7)
Anti vibration system	Silentblock
Adjustment	-10%; -7.5%; -5%; -2.5%; +2.5%; +5%; +7.5%; +10% With bridges (figure 8) or selector (figure 9)
Certified	CE, DNV-GL, BV, UL (insulation) and POLYLUX laboratory
Climate class / environment / fire	Up to C2-E2-F1



Figure 1



Figure 2



Figure 3



Figure 4



Figure 5



Figure 6



Figure 7



Figure 8



Figure 9



TT SERIES

Isolation · Input 400 V · Output 400 V + N

Feature plate structure

Plastic label up to 31,5 kVA:

POLYLUX®		CE		CE declaration of conformity	
Power (kVA)	XXX kVA	PRI:	400 V <small>XXX A</small>	Primary voltage	
Reference	<small>TTXXXX</small>	SEC:	400 V <small>XXX A</small>	Primary current	
Frequency	<small>50 - 60 Hz</small>	F-155°C	IP-XX	Secondary voltage	
Insulation transformer symbol		<small>Yyn0</small>	3kV	Secondary current	
Connection unit	<small>SN: TTXXXXXXX</small>	<small>EN 61558</small>		IP rating	
Serial number	<small>Made in Spain</small>	<small>9 638 456 958 502</small>		Applicable standard	
				EAN bar code	
				Test voltage	
				Insulators	

Stainless steel label from 40 kVA:

POLYLUX®		<small>www.polylux.com</small>		Insulators	
Performance	XXX kVA	PRI:	XXX V <small>XXX A</small>	Test voltage	
Short circuit voltage	<small>50 - 60 Hz</small>	SEC:	XXX V <small>XXX A</small>	Primary voltage	
Power (kVA)	<small>H-180°C</small>	<small>IEC 60076</small>	IP-XX	Primary current	
Frequency	<small>Yyn0</small>	3 kV		Secondary voltage	
Insulation transformer symbol		<small>Pcc= XXX W</small>	<small>η= XX %</small>	Secondary current	
Connection unit	CE	<small>Po= XXX W</small>	<small>Ucc= X %</small>	Applicable standard	
CE declaration of conformity	<small>Made in Spain</small>	<small>ANXX</small>	<small>XXXX kg</small>	Protection rating	
Losses in short circuit		<small>TTXXXX</small>		Cooling	
Losses when empty		<small>SN: TTXXXXXXXXXX</small>		Weight	
				Reference	
				Serial number	





TTU SERIES

Isolation · Input 230 V · Output 400 V + N

Definition and applications

Our TTU series are three-phase isolation transformers designed for continuous operation at maximum output 365 days a year. This guarantees power is supplied to the installations or equipment they supply.

Applications:

- The main application of the TTU transformers is the isolation of circuits, by raising the voltage from 230V up to 400V.
- In installations with a certain level of electrical noise, the TTU series helps improve the electrical network quality in secondary.
- Changing the neutral system of an installation.

Manufacturing characteristics

- All the transformers are dipped in anti-flash varnish and then compacted in the furnace. This process increases the insulation grade, reduces noise and provides anti-moisture, waterproofed protection
- The high power transformers are manufactured with format cores and low loss properties, thus contributing to improving performance.
- All the transformers are checked automatically one by one and the compliance test report is created in accordance with the corresponding standard.

Recommendation for selecting the best transformer in terms of use and installation location

Main compliance properties based on model	Encapsulated in resin	IP00 Air	Oil	Considerations
Non-flammable	✓	✗	✗	<ul style="list-style-type: none"> • The IP00 (air) can be installed in control cabinets with all the necessary protections and in dry places, which is more economical. • Both models (encapsulated and IP00) can be protected with metallic enclosures up to IP65. • In addition, the ECOLOGICAL transformer can be manufactured in both models, with different properties such as lower consumption, thus achieving fast amortisation. • The transformer with the best properties is the transformer encapsulated in fire retardant resin.
Self-extinguishing.	✓	✗	✗	
No safety measures against the risk of explosion	✓	✓	✗	
No special installation conditions	✓	✓	✗	
Protected against damp, saline and corrosive environments	✓	✗	✓	
Greater resistance to overload and transient harmonics	✓	✗	✗	
No maintenance	✓	✓	✗	
No risk of contamination	✓	✓	✗	



TTUX

- IP00 protection rating.
- Power from 0.63 kVA to 1000 kVA.
- Total impregnated in anti-flash varnish.
- Hoisting elements included.



TTUW

- IP23 rating (IK08).
- Power from 0.63 kVA to 1000 kVA.
- Metal box painted with RAL7035 polyester resin.
- High resistance to corrosion.
- Hoisting elements included.
- Detachable top and front cover.
- Cable outlet with cable gland.



TTUZ

- IP54 rating / 65 (IK10).
- Power from 0.63 kVA to 1000 kVA.
- Metal box painted with RAL7035 polyester resin.
- High resistance to corrosion.
- Hoisting elements included.
- Detachable top cover.
- Stuffing box cover for cable input depending on installation needs.
- With silentblock.



TTU SERIES

Isolation · Input 230 V · Output 400 V + N

Technical features - standard model

Standard voltage	Input 230 V // Output 400 V and N.
Standard frequency	50-60 Hz
Connection unit	Yyn0
Windings	Class HC-200 °C
Insulators	Class F - 155 °C ≤ 31.5 kVA (25 kVA TTUX) Class H - 180 °C ≥ 40 kVA (31.5 kVA TTUZ) <small>*More information in Technical Appendix (T.A.1)</small>
Safety class	I
Altitude	1000 m
Enclosure colour	RAL 7035
IP rating	IP00 (TTUX) IP23 (TTUW) IP54 / 65 (TTUZ)
IK rating	IK08 (TTUW) IK10 (TTUZ)
Paint class (ISO 12944)	C3 (TTUW) C4 (TTUZ)
Room temperature	45 °C
Standards	IEC/EN 61558, CE up to 31.5 kVA IEC/EN 60076, CE from 40 kVA
Test voltage	3 kV (1 min, 50 Hz)
Inrush	< 12 In
Ucc	≤ 4 %
K factor	4
Operation	Continuous
Cooling	AN (TTUX) - ANAN (TTUW / TTUZ)
Hoisting accessories	Hoisting elements included.

Electrical diagram

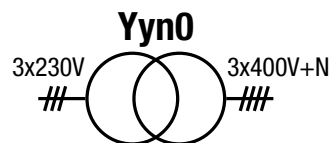
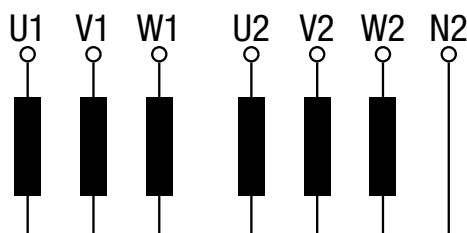

Theoretical data - standard model

Power kVA	Reference	Insulation class	Current A		Protections A		Noise dB	Cable gland	
			Input	Output	Input	Output		ø max. (mm)	Quantity
TTUX									
0.63	TTUX0.63	F	1.6	0.9	4 (D/aM)	1 (C/gG)	≤45	-	-
1	TTUX1	F	2.5	1.4	6 (D/aM)	1.6 (C/gG)	≤45	-	-
2	TTUX2	F	5	2.9	10 (D/aM)	3 (C/gG)	≤45	-	-
2.5	TTUX2.5	F	6.3	3.6	16 (D/aM)	3 (C/gG)	≤45	-	-
3.15	TTUX3.15	F	7.9	4.6	16 (D/aM)	4 (C/gG)	≤45	-	-
4	TTUX4	F	10	5.8	20 (D/aM)	5 (C/gG)	≤45	-	-
5	TTUX5	F	12.6	7.2	32 (D/aM)	6 (C/gG)	≤45	-	-
6.3	TTUX6.3	F	15.8	9.1	40 (D/aM)	10 (C/gG)	≤45	-	-
8	TTUX8	F	20.1	11.6	50 (D/aM)	12 (C/gG)	≤45	-	-
10	TTUX10	F	25.1	14.5	63 (D/aM)	16 (C/gG)	≤45	-	-
12.5	TTUX12.5	F	31.4	18.1	80 (D/aM)	16 (C/gG)	≤45	-	-
16	TTUX16	F	40.2	23.1	100 (D/aM)	20 (C/gG)	≤45	-	-
20	TTUX20	F	50.2	28.9	125 (D/aM)	25 (C/gG)	≤45	-	-
25	TTUX25	F	62.8	36.1	160 (D/aM)	32 (C/gG)	≤45	-	-
31.5	TTUX31.5	F	79.1	45.5	160 (D/aM)	40 (C/gG)	≤45	-	-
40	TTUX40	H	100	57.8	200 (D/aM)	50 (C/gG)	≤55	-	-
50	TTUX50	H	126	72.3	300 (D/aM)	63 (C/gG)	≤55	-	-
63	TTUX63	H	158	91	400 (D/aM)	80 (C/gG)	≤55	-	-
80	TTUX80	H	201	116	500 (D/aM)	100 (C/gG)	≤55	-	-
100	TTUX100	H	251	145	600 (D/aM)	125 (C/gG)	≤55	-	-
125	TTUX125	H	314	181	800 (D/aM)	160 (C/gG)	≤55	-	-
160	TTUX160	H	402	231	800 (D/aM)	200 (C/gG)	≤55	-	-
200	TTUX200	H	502	289	1000 (D/aM)	250 (C/gG)	≤55	-	-
250	TTUX250	H	628	361	1600 (D/aM)	300 (C/gG)	≤65	-	-
315	TTUX315	H	791	455	1600 (D/aM)	400 (C/gG)	≤65	-	-
400	TTUX400	H	1004	578	2000 (D/aM)	500 (C/gG)	≤65	-	-
500	TTUX500	H	1255	723	2600 (D/aM)	630 (C/gG)	≤65	-	-
630	TTUX630	H	1581	910	3000 (D/aM)	800 (C/gG)	≤65	-	-
800	TTUX800	H	2008	1156	4000 (D/aM)	1000 (C/gG)	≤65	-	-
1000	TTUX1000	H	2510	1445	5000 (D/aM)	1250 (C/gG)	≤65	-	-





TTU SERIES

Isolation · Input 230 V · Output 400 V + N

Theoretical data - standard model

Power kVA	Reference	Insulation class	Current A		Protections A		Noise dB	Cable gland (TTUW) Stuffing boxes (TTUZ)	
			Input	Output	Input	Output		ø max. (mm)	Quantity
TTUW									
0.63	TTUW0.63	F	1.6	0.9	4 (D/aM)	1 (C/gG)	≤45	14	2
1	TTUW1	F	2.5	1.4	6 (D/aM)	1.6 (C/gG)	≤45	14	2
2	TTUW2	F	5	2.9	10 (D/aM)	3 (C/gG)	≤45	14	2
2.5	TTUW2.5	F	6.3	3.6	16 (D/aM)	3 (C/gG)	≤45	18	2
3.15	TTUW3.15	F	7.9	4.6	16 (D/aM)	4 (C/gG)	≤45	18	2
4	TTUW4	F	10	5.8	20 (D/aM)	5 (C/gG)	≤45	18	2
5	TTUW5	F	12.6	7.2	32 (D/aM)	6 (C/gG)	≤45	18	2
6.3	TTUW6.3	F	15.8	9.1	40 (D/aM)	10 (C/gG)	≤45	25	4
8	TTUW8	F	20.1	11.6	50 (D/aM)	12 (C/gG)	≤45	25	4
10	TTUW10	F	25.1	14.5	63 (D/aM)	16 (C/gG)	≤45	32	4
12.5	TTUW12.5	F	31.4	18.1	80 (D/aM)	16 (C/gG)	≤45	32	4
16	TTUW16	F	40.2	23.1	100 (D/aM)	20 (C/gG)	≤45	32	4
20	TTUW20	F	50.2	28.9	125 (D/aM)	25 (C/gG)	≤45	32	4
25	TTUW25	F	62.8	36.1	160 (D/aM)	32 (C/gG)	≤45	32	4
31.5	TTUW31.5	F	79.1	45.5	160 (D/aM)	40 (C/gG)	≤45	32	4
40	TTUW40	H	100	57.8	200 (D/aM)	50 (C/gG)	≤55	32	8
50	TTUW50	H	126	72.3	300 (D/aM)	63 (C/gG)	≤55	32	8
63	TTUW63	H	158	91	400 (D/aM)	80 (C/gG)	≤55	32	8
80	TTUW80	H	201	116	500 (D/aM)	100 (C/gG)	≤55	32	8
100	TTUW100	H	251	145	600 (D/aM)	125 (C/gG)	≤55	32	8
125	TTUW125	H	314	181	800 (D/aM)	160 (C/gG)	≤55	44	8
160	TTUW160	H	402	231	800 (D/aM)	200 (C/gG)	≤55	44	8
200	TTUW200	H	502	289	1000 (D/aM)	250 (C/gG)	≤55	44	8
250	TTUW250	H	628	361	1600 (D/aM)	300 (C/gG)	≤65	44	8
315	TTUW315	H	791	455	1600 (D/aM)	400 (C/gG)	≤65	44	8
400	TTUW400	H	1004	578	2000 (D/aM)	500 (C/gG)	≤65	44	8
500	TTUW500	H	1255	723	2600 (D/aM)	630 (C/gG)	≤65	44	8
630	TTUW630	H	1581	910	3000 (D/aM)	800 (C/gG)	≤65	44	8
800	TTUW800	H	2008	1156	4000 (D/aM)	1000 (C/gG)	≤65	44	8
1000	TTUW1000	H	2510	1445	5000 (D/aM)	1250 (C/gG)	≤65	44	8
TTUZ									
0.63	TTUZ0.63	F	1.6	0.9	4 (D/aM)	1 (C/gG)	≤45	10 - 14	2
1	TTUZ1	F	2.5	1.4	6 (D/aM)	1.6 (C/gG)	≤45	10 - 14	2
2	TTUZ2	F	5	2.9	10 (D/aM)	3 (C/gG)	≤45	10 - 14	2
2.5	TTUZ2.5	F	6.3	3.6	16 (D/aM)	3 (C/gG)	≤45	18 - 25	2
3.15	TTUZ3.15	F	7.9	4.6	16 (D/aM)	4 (C/gG)	≤45	18 - 25	2
4	TTUZ4	F	10	5.8	20 (D/aM)	5 (C/gG)	≤45	18 - 25	2
5	TTUZ5	F	12.6	7.2	32 (D/aM)	6 (C/gG)	≤45	18 - 25	2
6.3	TTUZ6.3	F	15.8	9.1	40 (D/aM)	10 (C/gG)	≤45	18 - 25	2
8	TTUZ8	F	20.1	11.6	50 (D/aM)	12 (C/gG)	≤45	18 - 25	2
10	TTUZ10	F	25.1	14.5	63 (D/aM)	16 (C/gG)	≤45	22 - 32	2
12.5	TTUZ12.5	F	31.4	18.1	80 (D/aM)	16 (C/gG)	≤45	22 - 32	2
16	TTUZ16	F	40.2	23.1	100 (D/aM)	20 (C/gG)	≤45	22 - 32	2
20	TTUZ20	F	50.2	28.9	125 (D/aM)	25 (C/gG)	≤45	22 - 32	2
25	TTUZ25	F	62.8	36.1	160 (D/aM)	32 (C/gG)	≤45	22 - 32	2
31.5	TTUZ31.5	F	79.1	45.5	160 (D/aM)	40 (C/gG)	≤45	22 - 32	2
40	TTUZ40	H	100	57.8	200 (D/aM)	50 (C/gG)	≤55	22 - 32	2
50	TTUZ50	H	126	72.3	300 (D/aM)	63 (C/gG)	≤55	22 - 32	2
63	TTUZ63	H	158	91	400 (D/aM)	80 (C/gG)	≤55	22 - 32	2
80	TTUZ80	H	201	116	500 (D/aM)	100 (C/gG)	≤55	22 - 32	2
100	TTUZ100	H	251	145	600 (D/aM)	125 (C/gG)	≤55	22 - 32	2
125	TTUZ125	H	314	181	800 (D/aM)	160 (C/gG)	≤55	34 - 44	2
160	TTUZ160	H	402	231	800 (D/aM)	200 (C/gG)	≤55	34 - 44	2
200	TTUZ200	H	502	289	1000 (D/aM)	250 (C/gG)	≤55	34 - 44	2
250	TTUZ250	H	628	361	1600 (D/aM)	300 (C/gG)	≤65	34 - 44	2
315	TTUZ315	H	791	455	1600 (D/aM)	400 (C/gG)	≤65	34 - 44	2
400	TTUZ400	H	1004	578	2000 (D/aM)	500 (C/gG)	≤65	34 - 44	2
500	TTUZ500	H	1255	723	2600 (D/aM)	630 (C/gG)	≤65	34 - 44	2
630	TTUZ630	H	1581	910	3000 (D/aM)	800 (C/gG)	≤65	34 - 44	2
800	TTUZ800	H	2008	1156	4000 (D/aM)	1000 (C/gG)	≤65	34 - 44	2
1000	TTUZ1000	H	2510	1445	5000 (D/aM)	1250 (C/gG)	≤65	34 - 44	2



TTU SERIES

Isolation · Input 230 V · Output 400 V + N

Measurements

Power kVA	Reference	External dimensions mm			Fastening elements mm			Weight kg
		A	B	C	D	E	∅	
TTUX								
0.63	TTUX0.63	150	94	178	66	125	6	5.9
1	TTUX1	180	94	203	76	150	6	9.5
2	TTUX2	240	145	253	125	200	9	20
2.5	TTUX2.5	300	124	303	115	250	9	23.9
3.15	TTUX3.15	300	134	303	125	250	9	27.4
4	TTUX4	300	154	303	145	250	9	36
5	TTUX5	300	164	303	155	250	9	40.4
6.3	TTUX6.3	360	144	353	122	300	11	55
8	TTUX8	360	164	353	142	300	11	67
10	TTUX10	420	170	419	136	350	11	78
12.5	TTUX12.5	420	190	419	156	350	11	94
16	TTUX16	480	250	480	144	400	11	105
20	TTUX20	480	270	480	164	400	11	125
25	TTUX25	480	290	480	184	400	11	145
31.5	TTUX31.5	480	310	480	204	400	11	162
40	TTUX40	670	280	615	170	426	13	191
50	TTUX50	670	300	615	190	426	13	233
63	TTUX63	670	320	690	210	426	13	277
80	TTUX80	670	340	690	230	426	13	320
100	TTUX100	670	360	690	250	426	13	368
125	TTUX125	785	550	880	460	472	17	462
160	TTUX160	785	550	880	460	472	17	560
200	TTUX200	785	550	880	460	472	17	660
250	TTUX250	1016	550	1080	460	690	17	808
315	TTUX315	1070	550	1220	460	690	17	1000
400	TTUX400	1070	550	1220	460	690	17	1092
500	TTUX500	1300	550	1350	460	800	17	1658
630	TTUX630	1300	600	1350	460	800	17	2000
800	TTUX800	1300	700	1350	600	800	17	2413
1000	TTUX1000	1300	800	1350	600	800	17	2993

Power kVA	Reference	External dimensions mm			Fastening elements mm			Weight kg
		A	B	C	D	E	∅	
TTUW								
0.63	TTUW0.63	194	175	220	165	100	6	7.6
1	TTUW1	240	190	250	180	150	6	13.2
2	TTUW2	315	230	315	205	200	6	24.8
2.5	TTUW2.5	385	260	384	245	250	6	28.8
3.15	TTUW3.15	385	260	384	245	250	6	32.8
4	TTUW4	385	260	384	245	250	6	40.8
5	TTUW5	385	260	384	245	250	6	45.2
6.3	TTUW6.3	458	340	500	300	300	12	61
8	TTUW8	458	340	500	300	300	12	73
10	TTUW10	528	418	644	375	345	12	89
12.5	TTUW12.5	528	418	644	375	345	12	106
16	TTUW16	597	415	710	375	345	12	117
20	TTUW20	597	415	710	375	345	12	137
25	TTUW25	597	415	710	375	345	12	157
31.5	TTUW31.5	597	415	710	375	345	12	174
40	TTUW40	795	550	970	500	415	12	237
50	TTUW50	795	550	970	500	415	12	279
63	TTUW63	795	550	970	500	415	12	323
80	TTUW80	795	550	970	500	415	12	366
100	TTUW100	795	550	970	500	415	12	414
125	TTUW125	970	670	1250	582	470	18	514
160	TTUW160	970	670	1250	582	470	18	612
200	TTUW200	970	670	1250	582	470	18	754
250	TTUW250	1200	760	1555	672	690	18	855
315	TTUW315	1200	760	1555	672	690	18	1093
400	TTUW400	1200	760	1555	672	690	18	1185
500	TTUW500	1530	1000	1880	900	800	20	1808
630	TTUW630	1530	1000	1880	900	800	20	2149
800	TTUW800	1530	1000	1880	900	800	20	2563
1000	TTUW1000	1530	1000	1880	900	800	20	3143

TTUX IP00

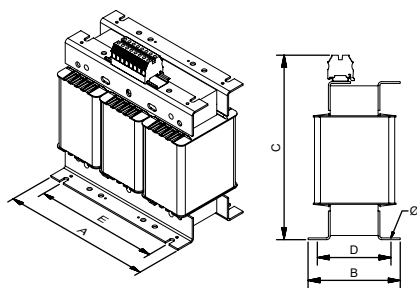

From 0.63 kVA to 12.5 kVA

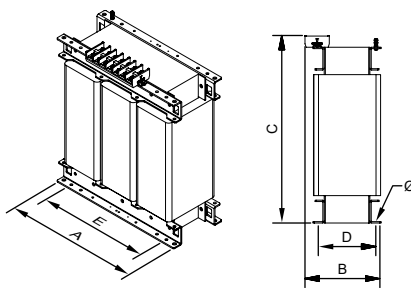

From 16 kVA to 200 kVA

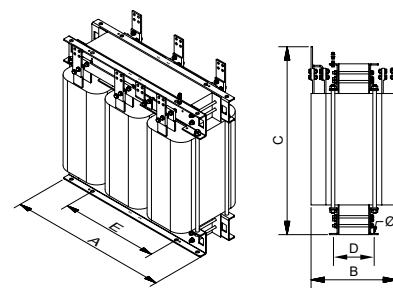

From 250 kVA

TTUW IP23

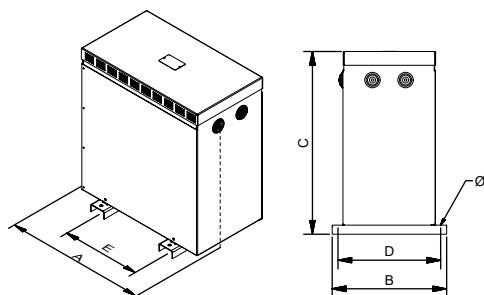

From 0.63 kVA to 31.5 kVA

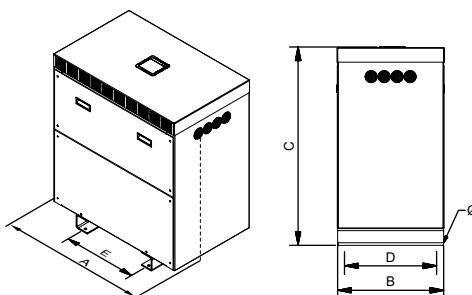

From 40 kVA



Sectioned



TTU SERIES

Isolation · Input 230 V · Output 400 V + N

Measurements

Power kVA	Reference	External dimensions mm			Fastening elements mm			Weight kg
		A	B	C	D	E	∅	
TTUZ								
0.63	TTUZ0.63	330	284	463	230	200	11	19.5
1	TTUZ1	330	284	463	230	200	11	24
2	TTUZ2	510	362	689	320	250	11	37
2.5	TTUZ2.5	510	362	689	320	250	11	40
3.15	TTUZ3.15	510	362	689	320	250	11	57
4	TTUZ4	510	362	689	320	250	11	61
5	TTUZ5	510	362	689	320	250	11	76
6.3	TTUZ6.3	510	362	689	320	250	11	87.5
8	TTUZ8	694	413	764	370	350	11	118
10	TTUZ10	694	413	764	370	350	11	134
12.5	TTUZ12.5	694	413	764	370	350	11	145
16	TTUZ16	694	413	764	370	350	11	165
20	TTUZ20	694	413	764	370	350	11	185
25	TTUZ25	694	413	764	370	350	11	202
31.5	TTUZ31.5	694	413	764	370	350	11	220
40	TTUZ40	890	560	1148	520	426	13	251
50	TTUZ50	890	560	1148	520	426	13	295
63	TTUZ63	890	560	1148	520	426	13	340
80	TTUZ80	890	560	1148	520	426	13	383
100	TTUZ100	890	560	1148	520	426	13	433
125	TTUZ125	972	740	1480	660	470	17	551
160	TTUZ160	972	740	1480	660	470	17	628
200	TTUZ200	972	740	1480	660	470	17	797
250	TTUZ250	1394	870	1762	810	690	17	1186
315	TTUZ315	1394	870	1762	810	690	17	1278
400	TTUZ400	1394	870	1762	810	690	17	1933
500	TTUZ500	1640	1226	1770	1110	800	17	2275
630	TTUZ630	1640	1226	1770	1110	800	17	2688
800	TTUZ800	1640	1226	1770	1110	800	17	3268
1000	TTUZ1000	1640	1226	1770	1110	800	17	3848

TTUZ IP54 / 65

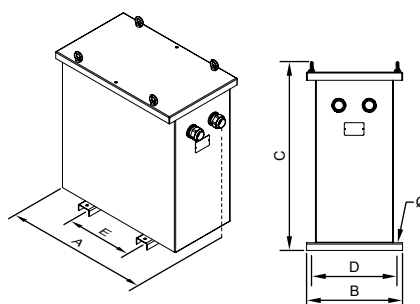



TTU SERIES

Isolation · Input **230 V** · Output **400 V + N**

On-request manufacturing options (please see prices)

Power	From 0.15 kVA to 1000 kVA
Voltage	From 1 V to 12 kV
Windings	Copper or aluminium
Frequency	From 50 Hz to 400 Hz
Connection unit	Yyn0, Dyn11, Dd0, Dy1, Dyn5, YNd1/5/11... (See Technical Appendix T.A.2)
IP rating	IP00, IP20, IP23, IP31, IP42, IP54, IP55 and IP65
IK rating	IK08 and IK10
Room temperature	Up to 60 °C
Locks	Screw, key
Test voltage	Up to 28 kV
Short circuit voltage	From 2% to 9%
Losses	Low losses, ecological
Operation	Intermittent, continuous
Cooling	Natural, forced ventilation
Electrostatic shield	Up to three shields
Safety class	I, II
Altitude	Up to 4000 m
Protections	In both primary and secondary (figure 1)
Temperature sensors	PT100 (figure 2), PTC (figure 3) or bimetallic
Temperature control	Temperature control station (4xPT100) (figure 4), PTC thermal relays (3xPTC / 6xPTC)
Network analyser	(Figure 5)
Anti condensation system	Higrostat
Heating system	Heating elements
External protection	Anti-flash varnish, resin encapsulated, metal or stainless steel enclosure
Transportation and hoisting	Wheels (figure 6), lifting points
Paint	C3, C4, C5, different RAL
Feature plate	High generation polymer or stainless steel (figure 7)
Anti vibration system	Silentblock
Adjustment	-10%; -7.5%; -5%; -2.5%; +2.5%; +5%; +7.5%; +10% With bridges (figure 8) or selector (figure 9)
Certified	CE, DNV-GL, BV, UL (insulation) and POLYLUX laboratory
Climate class / environment / fire	Up to C2-E2-F1



Figure 1



Figure 2



Figure 3



Figure 4



Figure 5



Figure 6



Figure 7



Figure 8



Figure 9



TTU SERIES

Isolation · Input 230 V · Output 400 V + N

Feature plate structure

Plastic label up to 31,5 kVA:

POLYLUX®		CE		CE declaration of conformity
Power (kVA)	XXX kVA	PRI:	400 V <small>XXX A</small>	Primary voltage
Reference	<small>TTUXXX</small>	SEC:	400 V <small>XXX A</small>	Primary current
Frequency	<small>50 - 60 Hz</small>	<small>F-155°C</small>	<small>IP-XX</small>	Secondary voltage
Insulation transformer symbol		<small>Yyn0</small>	<small>3kV</small>	Secondary current
Connection unit	<small>SN: TTXXXXXXX</small>	<small>EN 61558</small>		IP rating
Serial number	<small>Made in Spain</small>	<small>9 638 456 958 502</small>		Applicable standard
				EAN bar code
				Test voltage
				Insulators

Stainless steel label from 40 kVA:

POLYLUX®		<small>www.polylux.com</small>		Insulators
Performance	XXX kVA	PRI:	XXX V <small>XXX A</small>	Test voltage
Short circuit voltage		SEC:	XXX V <small>XXX A</small>	Primary voltage
Power (kVA)		<small>50 - 60 Hz</small>	<small>H-180°C</small>	Primary current
Frequency		<small>Yyn0</small>	<small>3 kV</small>	Secondary voltage
Insulation transformer symbol		<small>Pcc= XXX W</small>	<small>η= XX %</small>	Secondary current
Connection unit	<small>CE</small>	<small>Po= XXX W</small>	<small>Ucc= X %</small>	Applicable standard
CE declaration of conformity	<small>Made in Spain</small>	<small>ANXX</small>	<small>XXXX kg</small>	Protection rating
Losses in short circuit		<small>TTUXXX</small>		Cooling
Losses when empty		<small>SN: TTUXXXXXX</small>		Weight
				Reference
				Serial number



TTD SERIES

Isolation · Input 400 V · Output 230 V + N

Definición y aplicaciones

Our TTD series are three-phase isolation transformers designed for continuous operation at maximum output 365 days a year. This guarantees power is supplied to the installations or equipment they supply.

Applications:

- The main application of the TT transformers is the isolation of circuits, by reducing the voltage from 400V up to 230V.
- In installations with a certain level of electrical noise, the TTD series helps improve the electrical network quality in secondary.
- Changing the neutral system of an installation.

Características de fabricación

- All the transformers are dipped in anti-flash varnish and then compacted in the furnace. This process increases the insulation grade, reduces noise and provides anti-moisture, waterproofed protection
- The high power transformers are manufactured with format cores and low loss properties, thus contributing to improving performance.
- All the transformers are checked automatically one by one and the compliance test report is created in accordance with the corresponding standard.

Recommendation for selecting the best transformer in terms of use and installation location

Main compliance properties based on model	Encapsulated in resin	IP00 Air	Oil	Considerations
Non-flammable	✓	✗	✗	<ul style="list-style-type: none"> • The IP00 (air) can be installed in control cabinets with all the necessary protections and in dry places, which is more economical. • Both models (encapsulated and IP00) can be protected with metallic enclosures up to IP65. • In addition, the ECOLOGICAL transformer can be manufactured in both models, with different properties such as lower consumption, thus achieving fast amortisation. • The transformer with the best properties is the transformer encapsulated in fire retardant resin.
Self-extinguishing.	✓	✗	✗	
No safety measures against the risk of explosion	✓	✓	✗	
No special installation conditions	✓	✓	✗	
Protected against damp, saline and corrosive environments	✓	✗	✓	
Greater resistance to overload and transient harmonics	✓	✗	✗	
No maintenance	✓	✓	✗	
No risk of contamination	✓	✓	✗	



TTDX

- IP00 protection rating.
- Power from 0.63 kVA to 1000 kVA.
- Total impregnated in anti-flash varnish.
- Hoisting elements included.



TTDW

- IP23 rating (IK08).
- Power from 0.63 kVA to 1000 kVA.
- Metal box painted with RAL7035 polyester resin.
- High resistance to corrosion.
- Hoisting elements included.
- Detachable top and front cover.
- Cable outlet with cable gland.



TTDZ

- IP54 rating / 65 (IK10).
- Power from 0.63 kVA to 1000 kVA.
- Metal box painted with RAL7035 polyester resin.
- High resistance to corrosion.
- Hoisting elements included.
- Detachable top cover.
- Stuffing box cover for cable input depending on installation needs.
- With silentblock.





TTD SERIES

Isolation · Input 400 V · Output 230 V + N

Technical features - standard model

Standard voltage	Input 400 V // Output 230 V and N.
Standard frequency	50-60 Hz
Connection unit	Yyn0
Windings	Class HC-200 °C
Insulators	Class F - 155 °C ≤ 31.5 kVA (25 kVA TTDZ) Class H - 180 °C ≥ 40 kVA (31.5 kVA TTDZ) <small>*More information in Technical Appendix (T.A.1)</small>
Safety class	I
Altitude	1000 m
Enclosure colour	RAL 7035
IP rating	IP00 (TTDX) IP23 (TTDW) IP54 / 65 (TTDZ)
IK rating	IK08 (TTDW) IK10 (TTDZ)
Paint class (ISO 12944)	C3 (TTDW) C4 (TTDZ)
Room temperature	45 °C
Standards	IEC/EN 61558, CE up to 31.5 kVA IEC/EN 60076, CE from 40 kVA
Test voltage	3 kV (1 min, 50 Hz)
Inrush	< 12 In
Ucc	≤ 4 %
K factor	4
Operation	Continuous
Cooling	AN (TTDX) - ANAN (TTDW / TTDZ)
Hoisting accessories	Hoisting elements included.

Electrical diagram

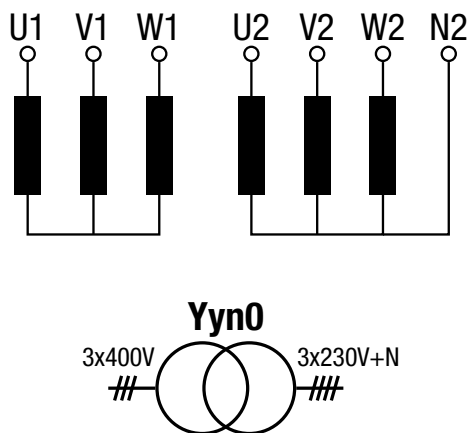

Theoretical data - standard model

Power kVA	Reference	Insulation class	Current A		Protections A		Noise dB	Cable gland	
			Input	Output	Input	Output		ø max. (mm)	Quantity
TTDX									
0.63	TTDX0.63	F	0.9	1.6	2 (D/aM)	1,6 (C/gG)	≤45	-	-
1	TTDX1	F	1.4	2.5	3 (D/aM)	2,5 (C/gG)	≤45	-	-
2	TTDX2	F	2.9	5	6 (D/aM)	5 (C/gG)	≤45	-	-
2.5	TTDX2.5	F	3.6	6.3	6 (D/aM)	6,3 (C/gG)	≤45	-	-
3.15	TTDX3.15	F	4.6	7.9	10 (D/aM)	8 (C/gG)	≤45	-	-
4	TTDX4	F	5.8	10	10 (D/aM)	10 (C/gG)	≤45	-	-
5	TTDX5	F	7.2	12.6	16 (D/aM)	12 (C/gG)	≤45	-	-
6.3	TTDX6.3	F	9.1	15.8	20 (D/aM)	16 (C/gG)	≤45	-	-
8	TTDX8	F	11.6	20.1	25 (D/aM)	20 (C/gG)	≤45	-	-
10	TTDX10	F	14.5	25.1	32 (D/aM)	25 (C/gG)	≤45	-	-
12.5	TTDX12.5	F	18.1	31.4	32 (D/aM)	30 (C/gG)	≤45	-	-
16	TTDX16	F	23.1	40.2	40 (D/aM)	40 (C/gG)	≤45	-	-
20	TTDX20	F	28.9	50.2	50 (D/aM)	50 (C/gG)	≤45	-	-
25	TTDX25	F	36.1	62.8	63 (D/aM)	60 (C/gG)	≤45	-	-
31.5	TTDX31.5	F	45.5	79.1	80 (D/aM)	80 (C/gG)	≤45	-	-
40	TTDX40	H	57.8	100	100 (D/aM)	100 (C/gG)	≤55	-	-
50	TTDX50	H	72.3	126	125 (D/aM)	100 (C/gG)	≤55	-	-
63	TTDX63	H	91	158	160 (D/aM)	160 (C/gG)	≤55	-	-
80	TTDX80	H	116	201	200 (D/aM)	200 (C/gG)	≤55	-	-
100	TTDX100	H	145	251	250 (D/aM)	250 (C/gG)	≤55	-	-
125	TTDX125	H	181	314	400 (D/aM)	300 (C/gG)	≤55	-	-
160	TTDX160	H	231	402	500 (D/aM)	400 (C/gG)	≤55	-	-
200	TTDX200	H	289	502	630 (D/aM)	500 (C/gG)	≤55	-	-
250	TTDX250	H	361	628	800 (D/aM)	600 (C/gG)	≤65	-	-
315	TTDX315	H	455	791	1000 (--/aM)	800 (C/gG)	≤65	-	-
400	TTDX400	H	578	1004	1250 (--/aM)	1000 (C/gG)	≤65	-	-
500	TTDX500	H	723	1255	1500 (--/aM)	1200 (C/gG)	≤65	-	-
630	TTDX630	H	910	1581	2000 (--/aM)	1500 (C/gG)	≤65	-	-
800	TTDX800	H	1156	2008	2500 (--/aM)	2000 (C/gG)	≤65	-	-
1000	TTDX1000	H	1445	2510	3000 (--/aM)	2500 (C/gG)	≤65	-	-



TTD SERIES

Isolation · Input 400 V · Output 230 V + N

Datos teóricos - modelo estándar

Power kVA	Reference	Insulation class	Current A		Protections A		Noise dB	Cable gland (TTDW) Stuffing boxes (TTDZ)	
			Input	Output	Input	Output		ø max. (mm)	Quantity
TTDW									
0.63	TTDW0.63	F	0.9	1.6	2 (D/aM)	1 (C/gG)	≤45	14	2
1	TTDW1	F	1.4	2.5	3 (D/aM)	1.6 (C/gG)	≤45	14	2
2	TTDW2	F	2.9	5	6 (D/aM)	3 (C/gG)	≤45	14	2
2.5	TTDW2.5	F	3.6	6.3	6 (D/aM)	3 (C/gG)	≤45	18	2
3.15	TTDW3.15	F	4.6	7.9	10 (D/aM)	4 (C/gG)	≤45	18	2
4	TTDW4	F	5.8	10	10 (D/aM)	5 (C/gG)	≤45	18	2
5	TTDW5	F	7.2	12.6	16 (D/aM)	6 (C/gG)	≤45	18	2
6.3	TTDW6.3	F	9.1	15.8	20 (D/aM)	10 (C/gG)	≤45	25	4
8	TTDW8	F	11.6	20.1	25 (D/aM)	12 (C/gG)	≤45	25	4
10	TTDW10	F	14.5	25.1	32 (D/aM)	16 (C/gG)	≤45	32	4
12.5	TTDW12.5	F	18.1	31.4	32 (D/aM)	16 (C/gG)	≤45	32	4
16	TTDW16	F	23.1	40.2	40 (D/aM)	20 (C/gG)	≤45	32	4
20	TTDW20	F	28.9	50.2	50 (D/aM)	25 (C/gG)	≤45	32	4
25	TTDW25	F	36.1	62.8	63 (D/aM)	32 (C/gG)	≤45	32	4
31.5	TTDW31.5	F	45.5	79.1	80 (D/aM)	40 (C/gG)	≤45	32	4
40	TTDW40	H	57.8	100	100 (D/aM)	50 (C/gG)	≤55	32	8
50	TTDW50	H	72.3	126	125 (D/aM)	63 (C/gG)	≤55	32	8
63	TTDW63	H	91	158	160 (D/aM)	80 (C/gG)	≤55	32	8
80	TTDW80	H	116	201	200 (D/aM)	100 (C/gG)	≤55	32	8
100	TTDW100	H	145	251	250 (D/aM)	125 (C/gG)	≤55	32	8
125	TTDW125	H	181	314	400 (D/aM)	160 (C/gG)	≤55	44	8
160	TTDW160	H	231	402	500 (D/aM)	200 (C/gG)	≤55	44	8
200	TTDW200	H	289	502	630 (D/aM)	250 (C/gG)	≤55	44	8
250	TTDW250	H	361	628	800 (D/aM)	300 (C/gG)	≤65	44	8
315	TTDW315	H	455	791	1000 (-/aM)	400 (C/gG)	≤65	44	8
400	TTDW400	H	578	1004	1250 (-/aM)	500 (C/gG)	≤65	44	8
500	TTDW500	H	723	1255	1500 (-/aM)	630 (C/gG)	≤65	44	8
630	TTDW630	H	910	1581	2000 (-/aM)	800 (C/gG)	≤65	44	8
800	TTDW800	H	1156	2008	2500 (-/aM)	1000 (C/gG)	≤65	44	8
1000	TTDW1000	H	1445	2510	3000 (-/aM)	1250 (C/gG)	≤65	44	8
TTDZ									
0.63	TTDZ0.63	F	0.9	1.6	2 (D/aM)	1 (C/gG)	≤45	10 - 14	2
1	TTDZ1	F	1.4	2.5	3 (D/aM)	1.6 (C/gG)	≤45	10 - 14	2
2	TTDZ2	F	2.9	5	6 (D/aM)	3 (C/gG)	≤45	10 - 14	2
2.5	TTDZ2.5	F	3.6	6.3	6 (D/aM)	3 (C/gG)	≤45	18 - 25	2
3.15	TTDZ3.15	F	4.6	7.9	10 (D/aM)	4 (C/gG)	≤45	18 - 25	2
4	TTDZ4	F	5.8	10	10 (D/aM)	5 (C/gG)	≤45	18 - 25	2
5	TTDZ5	F	7.2	12.6	16 (D/aM)	6 (C/gG)	≤45	18 - 25	2
6.3	TTDZ6.3	F	9.1	15.8	20 (D/aM)	10 (C/gG)	≤45	18 - 25	2
8	TTDZ8	F	11.6	20.1	25 (D/aM)	12 (C/gG)	≤45	18 - 25	2
10	TTDZ10	F	14.5	25.1	32 (D/aM)	16 (C/gG)	≤45	22 - 32	2
12.5	TTDZ12.5	F	18.1	31.4	32 (D/aM)	16 (C/gG)	≤45	22 - 32	2
16	TTDZ16	F	23.1	40.2	40 (D/aM)	20 (C/gG)	≤45	22 - 32	2
20	TTDZ20	F	28.9	50.2	50 (D/aM)	25 (C/gG)	≤45	22 - 32	2
25	TTDZ25	F	36.1	62.8	63 (D/aM)	32 (C/gG)	≤45	22 - 32	2
31.5	TTDZ31.5	F	45.5	79.1	80 (D/aM)	40 (C/gG)	≤45	22 - 32	2
40	TTDZ40	H	57.8	100	100 (D/aM)	50 (C/gG)	≤55	22 - 32	2
50	TTDZ50	H	72.3	126	125 (D/aM)	63 (C/gG)	≤55	22 - 32	2
63	TTDZ63	H	91	158	160 (D/aM)	80 (C/gG)	≤55	22 - 32	2
80	TTDZ80	H	116	201	200 (D/aM)	100 (C/gG)	≤55	22 - 32	2
100	TTDZ100	H	145	251	250 (D/aM)	125 (C/gG)	≤55	22 - 32	2
125	TTDZ125	H	181	314	400 (D/aM)	160 (C/gG)	≤55	34 - 44	2
160	TTDZ160	H	231	402	500 (D/aM)	200 (C/gG)	≤55	34 - 44	2
200	TTDZ200	H	289	502	630 (D/aM)	250 (C/gG)	≤55	34 - 44	2
250	TTDZ250	H	361	628	800 (D/aM)	300 (C/gG)	≤65	34 - 44	2
315	TTDZ315	H	455	791	1000 (-/aM)	400 (C/gG)	≤65	34 - 44	2
400	TTDZ400	H	578	1004	1250 (-/aM)	500 (C/gG)	≤65	34 - 44	2
500	TTDZ500	H	723	1255	1500 (-/aM)	630 (C/gG)	≤65	34 - 44	2
630	TTDZ630	H	910	1581	2000 (-/aM)	800 (C/gG)	≤65	34 - 44	2
800	TTDZ800	H	1156	2008	2500 (-/aM)	1000 (C/gG)	≤65	34 - 44	2
1000	TTDZ1000	H	1445	2510	3000 (-/aM)	1250 (C/gG)	≤65	34 - 44	2



TTD SERIES

Isolation · Input 400 V · Output 230 V + N

Measurements

Power kVA	Reference	External dimensions mm			Fastening elements mm			Weight kg
		A	B	C	D	E	∅	
TTDX								
0.63	TTDX0.63	150	94	178	66	125	6	5.9
1	TTDX1	180	94	203	76	150	6	9.5
2	TTDX2	240	145	253	125	200	9	20
2.5	TTDX2.5	300	124	303	115	250	9	23.9
3.15	TTDX3.15	300	134	303	125	250	9	27.4
4	TTDX4	300	154	303	145	250	9	36
5	TTDX5	300	164	303	155	250	9	40.4
6.3	TTDX6.3	360	144	353	122	300	11	55
8	TTDX8	360	164	353	142	300	11	67
10	TTDX10	420	170	419	136	350	11	78
12.5	TTDX12.5	420	190	419	156	350	11	94
16	TTDX16	480	250	480	144	400	11	105
20	TTDX20	480	270	480	164	400	11	125
25	TTDX25	480	290	480	184	400	11	145
31.5	TTDX31.5	480	310	480	204	400	11	162
40	TTDX40	670	280	615	170	426	13	191
50	TTDX50	670	300	615	190	426	13	233
63	TTDX63	670	320	690	210	426	13	277
80	TTDX80	670	340	690	230	426	13	320
100	TTDX100	670	360	690	250	426	13	368
125	TTDX125	785	550	880	460	472	17	462
160	TTDX160	785	550	880	460	472	17	560
200	TTDX200	785	550	880	460	472	17	660
250	TTDX250	1016	550	1080	460	690	17	808
315	TTDX315	1070	550	1220	460	690	17	1000
400	TTDX400	1070	550	1220	460	690	17	1092
500	TTDX500	1300	550	1350	460	800	17	1658
630	TTDX630	1300	600	1350	460	800	17	2000
800	TTDX800	1300	700	1350	600	800	17	2413
1000	TTDX1000	1300	800	1350	600	800	17	2993

Power kVA	Reference	External dimensions mm			Fastening elements mm			Weight kg
		A	B	C	D	E	∅	
TTDW								
0.63	TTDW0.63	194	175	220	165	100	6	7.6
1	TTDW1	240	190	250	180	150	6	13.2
2	TTDW2	315	230	315	205	200	6	24.8
2.5	TTDW2.5	385	260	384	245	250	6	28.8
3.15	TTDW3.15	385	260	384	245	250	6	32.8
4	TTDW4	385	260	384	245	250	6	40.8
5	TTDW5	385	260	384	245	250	6	45.2
6.3	TTDW6.3	458	340	500	300	300	12	61
8	TTDW8	458	340	500	300	300	12	73
10	TTDW10	528	418	644	375	345	12	89
12.5	TTDW12.5	528	418	644	375	345	12	106
16	TTDW16	597	415	710	375	345	12	117
20	TTDW20	597	415	710	375	345	12	137
25	TTDW25	597	415	710	375	345	12	157
31.5	TTDW31.5	597	415	710	375	345	12	174
40	TTDW40	795	550	970	500	415	12	237
50	TTDW50	795	550	970	500	415	12	279
63	TTDW63	795	550	970	500	415	12	323
80	TTDW80	795	550	970	500	415	12	366
100	TTDW100	795	550	970	500	415	12	414
125	TTDW125	970	670	1250	582	470	18	514
160	TTDW160	970	670	1250	582	470	18	612
200	TTDW200	970	670	1250	582	470	18	754
250	TTDW250	1200	760	1555	672	690	18	855
315	TTDW315	1200	760	1555	672	690	18	1093
400	TTDW400	1200	760	1555	672	690	18	1185
500	TTDW500	1530	1000	1880	900	800	20	1808
630	TTDW630	1530	1000	1880	900	800	20	2149
800	TTDW800	1530	1000	1880	900	800	20	2563
1000	TTDW1000	1530	1000	1880	900	800	20	3143

TTDX IP00

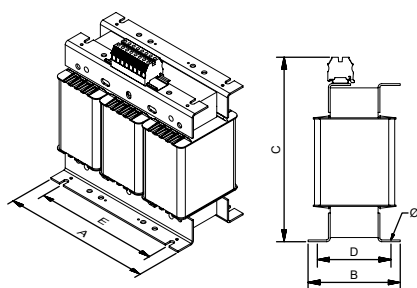

From 0.63 kVA to 12.5 kVA

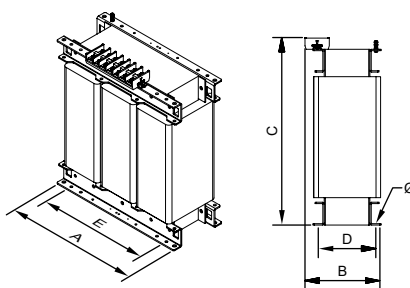

From 16 kVA to 200 kVA

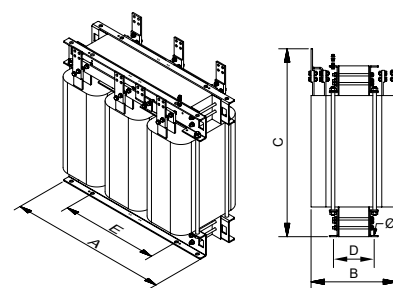

From 250 kVA

TTDW IP23

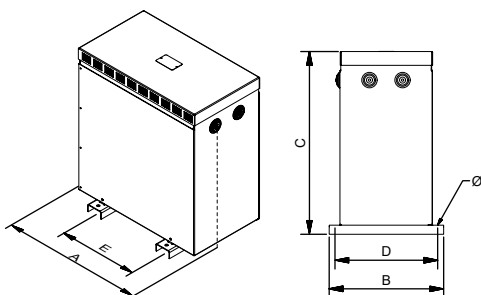

From 0.63 kVA to 31.5 kVA

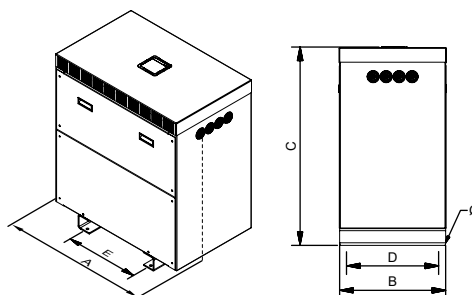

From 40 kVA



Sectioned



TTD SERIES

Isolation · Input 400 V · Output 230 V + N

Measurements

Power kVA	Reference	External dimensions mm			Fastening elements mm			Weight kg
		A	B	C	D	E	Ø	
TTDZ								
0.63	TTDZ0.63	330	284	463	230	200	11	19.5
1	TTDZ1	330	284	463	230	200	11	24
2	TTDZ2	510	362	689	320	250	11	37
2.5	TTDZ2.5	510	362	689	320	250	11	40
3.15	TTDZ3.15	510	362	689	320	250	11	57
4	TTDZ4	510	362	689	320	250	11	61
5	TTDZ5	510	362	689	320	250	11	76
6.3	TTDZ6.3	510	362	689	320	250	11	87.5
8	TTDZ8	694	413	764	370	350	11	118
10	TTDZ10	694	413	764	370	350	11	134
12.5	TTDZ12.5	694	413	764	370	350	11	145
16	TTDZ16	694	413	764	370	350	11	165
20	TTDZ20	694	413	764	370	350	11	185
25	TTDZ25	694	413	764	370	350	11	202
31.5	TTDZ31.5	694	413	764	370	350	11	220
40	TTDZ40	890	560	1148	520	426	13	251
50	TTDZ50	890	560	1148	520	426	13	295
63	TTDZ63	890	560	1148	520	426	13	340
80	TTDZ80	890	560	1148	520	426	13	383
100	TTDZ100	890	560	1148	520	426	13	433
125	TTDZ125	972	740	1480	660	470	17	551
160	TTDZ160	972	740	1480	660	470	17	628
200	TTDZ200	972	740	1480	660	470	17	797
250	TTDZ250	1394	870	1762	810	690	17	1186
315	TTDZ315	1394	870	1762	810	690	17	1278
400	TTDZ400	1394	870	1762	810	690	17	1933
500	TTDZ500	1640	1226	1770	1110	800	17	2275
630	TTDZ630	1640	1226	1770	1110	800	17	2688
800	TTDZ800	1640	1226	1770	1110	800	17	3268
1000	TTDZ1000	1640	1226	1770	1110	800	17	3848

TTDZ IP54 / 65

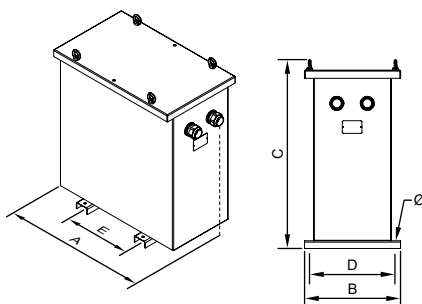



TTD SERIES

Isolation · Input **400 V** · Output **230 V + N**

On-request manufacturing options (please see prices)

Power	From 0.15 kVA to 1000 kVA
Voltage	From 1 V to 12 kV
Windings	Copper or aluminium
Frequency	From 50 Hz to 400 Hz
Connection unit	Yyn0, Dyn11, Dd0, Dy1, Dyn5, YNd1/5/11... (See Technical Appendix T.A.2)
IP rating	IP00, IP20, IP23, IP31, IP42, IP54, IP55 and IP65
IK rating	IK08 and IK10
Room temperature	Up to 60 °C
Locks	Screw, key
Test voltage	Up to 28 kV
Short circuit voltage	From 2% to 9%
Losses	Low losses, ecological
Operation	Intermittent, continuous
Cooling	Natural, forced ventilation
Electrostatic shield	Up to three shields
Safety class	I, II
Altitude	Up to 4000 m
Protections	In both primary and secondary (figure 1)
Temperature sensors	PT100 (figure 2), PTC (figure 3) or bimetallic
Temperature control	Temperature control station (4xPT100) (figure 4), PTC thermal relays (3xPTC / 6xPTC)
Network analyser	(Figure 5)
Anti condensation system	Higrostat
Heating system	Heating elements
External protection	Anti-flash varnish, resin encapsulated, metal or stainless steel enclosure
Transportation and hoisting	Wheels (figure 6), lifting points
Paint	C3, C4, C5, different RAL
Feature plate	High generation polymer or stainless steel (figure 7)
Anti vibration system	Silentblock
Adjustment	-10%; -7.5%; -5%; -2.5%; +2.5%; +5%; +7.5%; +10% With bridges (figure 8) or selector (figure 9)
Certified	CE, DNV-GL, BV, UL (insulation) and POLYLUX laboratory
Climate class / environment / fire	Up to C2-E2-F1



Figure 1



Figure 2



Figure 3



Figure 4



Figure 5



Figure 6



Figure 7



Figure 8



Figure 9



TTD SERIES

Isolation · Input 400 V · Output 230 V + N

Feature plate structure

Plastic label up to 31,5 kVA:

POLYLUX®		CE		CE declaration of conformity	
Power (kVA)	XXX kVA	PRI:	400 V <small>XXX A</small>	Primary voltage	
Reference	<small>TTDXXX</small>	SEC:	400 V <small>XXX A</small>	Primary current	
Frequency	50 - 60 Hz	F-155°C	IP-XX	Secondary voltage	
Insulation transformer symbol		Yyn0	3kV	Secondary current	
Connection unit	SN: TTXXXXXXX	EN 61558	EN 61558	IP rating	
Serial number	<small>Made in Spain</small>		9 638 456 958 502	Applicable standard	
				EAN bar code	
				Test voltage	
				Insulators	

Stainless steel label from 40 kVA:

POLYLUX®		www.polylux.com		Insulators	
Performance	XXX kVA	PRI:	XXX V <small>XXX A</small>	Test voltage	
Short circuit voltage	50 - 60 Hz	SEC:	XXX V <small>XXX A</small>	Primary voltage	
Power (kVA)	Yyn0	H-180°C	IEC 60076	Primary current	
Frequency	3 kV	IP-XX		Secondary voltage	
Insulation transformer symbol		Pcc= XXX W	η= XX %	Secondary current	
Connection unit	CE	Po= XXX W	Ucc= X %	Applicable standard	
CE declaration of conformity	<small>Made in Spain</small>	ANXX	XXXX kg	Protection rating	
Losses in short circuit		TTDXXX		Cooling	
Losses when empty		SN: TTDXXXXXX		Weight	
				Reference	
				Serial number	



TTF SERIES

Input **800 V +N** · Output **400 V +N**

Definición y aplicaciones

Definition and applications

Our TTF series are three-phase isolation transformers designed for continuous operation at maximum output 365 days a year. This guarantees power is supplied to the installations or equipment they supply.



Applications:

- The main use of TTF transformers is for the galvanic isolation of three-phase solar installations.
- In installations with a certain level of electrical noise, the TTF series helps improve the electrical network quality in secondary.
- Generation of ground-referenced neutrals.

Características de fabricación

- All the transformers are dipped in anti-flash varnish and then compacted in the furnace. This process increases the insulation grade, reduces noise and provides anti-moisture, waterproofed protection
- The high power transformers are manufactured with format cores and low loss properties, thus contributing to improving performance.
- All the transformers are checked automatically one by one and the compliance test report is created in accordance with the corresponding standard.

Recommendation for selecting the best transformer in terms of use and installation location

Main compliance properties based on model	  			Considerations
	Encapsulated in resin	IP00 Air	Oil	
Non-flammable	✓	✗	✗	<ul style="list-style-type: none"> • The IP00 (air) can be installed in control cabinets with all the necessary protections and in dry places, which is more economical. • Both models (encapsulated and IP00) can be protected with metallic enclosures up to IP65. • In addition, the ECOLOGICAL transformer can be manufactured in both models, with different properties such as lower consumption, thus achieving fast amortisation. • The transformer with the best properties is the transformer encapsulated in fire retardant resin.
Self-extinguishing.	✓	✗	✗	
No safety measures against the risk of explosion	✓	✓	✗	
No special installation conditions	✓	✓	✗	
Protected against damp, saline and corrosive environments	✓	✗	✓	
Greater resistance to overload and transient harmonics	✓	✗	✗	
No maintenance	✓	✓	✗	
No risk of contamination	✓	✓	✗	



TTFX

- IP00 protection rating.
- Power from 0.63 kVA to 1000 kVA.
- Total impregnated in anti-flash varnish.
- Hoisting elements included.



TTFW

- IP23 rating (IK08).
- Power from 0.63 kVA to 1000 kVA.
- Metal box painted with RAL7035 polyester resin.
- High resistance to corrosion.
- Hoisting elements included.
- Detachable top and front cover.
- Cable outlet with cable gland.



TTFZ

- IP54 rating / 65 (IK10).
- Power from 0.63 kVA to 1000 kVA.
- Metal box painted with RAL7035 polyester resin.
- High resistance to corrosion.
- Hoisting elements included.
- Detachable top cover.
- Stuffing box cover for cable input depending on installation needs.
- With silentblock.



TTF SERIES

Input 800 V +N · Output 400 V +N

Technical features - standard model

Standard voltage	Input 800 V // Output 400 V and N.
Standard frequency	50-60 Hz
Connection unit	Yyn0
Windings	Class HC-200 °C
Insulators	Class F - 155 °C ≤ 31.5 kVA (25 kVA TTFZ) Class H - 180 °C ≥ 40 kVA (31.5 kVA TTFZ) <small>*More information in Technical Appendix (T.A.1)</small>
Safety class	I
Altitude	1000 m
Enclosure colour	RAL 7035
IP rating	IP00 (TTFX) IP23 (TTFW) IP54 / 65 (TTFZ)
IK rating	IK08 (TTFW) IK10 (TTFZ)
Paint class (ISO 12944)	C3 (TTFW) C4 (TTFZ)
Room temperature	45 °C
Standards	IEC/EN 61558, CE up to 31.5 kVA IEC/EN 60076, CE from 40 kVA
Test voltage	3 kV (1 min, 50 Hz)
Inrush	< 12 In
Ucc	≤ 4 %
K factor	4
Operation	Continuous
Cooling	AN (TTFX) - ANAN (TTFW / TTFZ)
Hoisting accessories	Hoisting elements included.

Electrical diagram

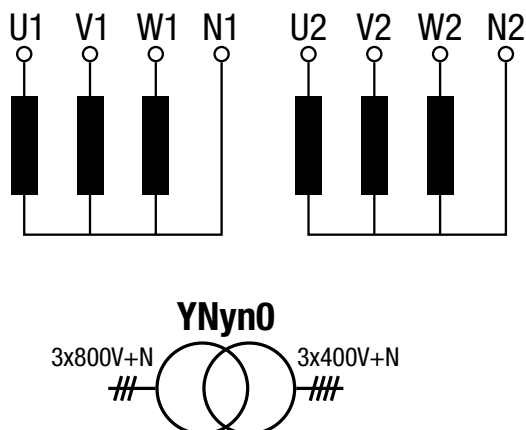

Theoretical data - standard model

Power kVA	Reference	Insulation class	Current A		Protections A		Noise dB	Cable gland	
			Input	Output	Input	Output		∅ max. (mm)	Quantity
TTFX									
0.63	TTFX0.63	F	0.5	0.9	2 (D/aM)	1 (C/gG)	≤45	-	-
1	TTFX1	F	0.7	1.4	2 (D/aM)	1.6 (C/gG)	≤45	-	-
2	TTFX2	F	1.4	2.9	3 (D/aM)	3 (C/gG)	≤45	-	-
2.5	TTFX2.5	F	1.8	3.6	4 (D/aM)	3 (C/gG)	≤45	-	-
3.15	TTFX3.15	F	2.3	4.5	6 (D/aM)	4 (C/gG)	≤45	-	-
4	TTFX4	F	2.9	5.8	10 (D/aM)	5 (C/gG)	≤45	-	-
5	TTFX5	F	3.6	7.2	10 (D/aM)	6 (C/gG)	≤45	-	-
6.3	TTFX6.3	F	4.5	9.1	10 (D/aM)	10 (C/gG)	≤45	-	-
8	TTFX8	F	5.8	11.5	16 (D/aM)	12 (C/gG)	≤45	-	-
10	TTFX10	F	7.2	14.4	16 (D/aM)	16 (C/gG)	≤45	-	-
12.5	TTFX12.5	F	9.0	18.0	20 (D/aM)	16 (C/gG)	≤45	-	-
16	TTFX16	F	11.5	23.1	25 (D/aM)	20 (C/gG)	≤45	-	-
20	TTFX20	F	14.4	28.9	32 (D/aM)	25 (C/gG)	≤45	-	-
25	TTFX25	F	18.0	36.1	40 (D/aM)	32 (C/gG)	≤45	-	-
31.5	TTFX31.5	F	22.7	45.5	50 (D/aM)	40 (C/gG)	≤45	-	-
40	TTFX40	H	28.9	57.7	63 (D/aM)	50 (C/gG)	≤55	-	-
50	TTFX50	H	36.1	72.2	80 (D/aM)	63 (C/gG)	≤55	-	-
63	TTFX63	H	45.5	90.9	100 (D/aM)	80 (C/gG)	≤55	-	-
80	TTFX80	H	57.7	115.5	125 (D/aM)	100 (C/gG)	≤55	-	-
100	TTFX100	H	72.2	144.3	160 (D/aM)	125 (C/gG)	≤55	-	-
125	TTFX125	H	90.2	180.4	200 (D/aM)	160 (C/gG)	≤55	-	-
160	TTFX160	H	115.5	230.9	300 (D/aM)	200 (C/gG)	≤55	-	-
200	TTFX200	H	144.3	288.7	300 (D/aM)	250 (C/gG)	≤55	-	-
250	TTFX250	H	180.4	360.8	400 (D/aM)	300 (C/gG)	≤65	-	-
315	TTFX315	H	227.3	454.7	500 (D/aM)	400 (C/gG)	≤65	-	-
400	TTFX400	H	288.7	577.4	600 (D/aM)	500 (C/gG)	≤65	-	-
500	TTFX500	H	360.8	721.7	800 (D/aM)	630 (C/gG)	≤65	-	-
630	TTFX630	H	454.7	909.3	1000 (D/aM)	800 (C/gG)	≤65	-	-
800	TTFX800	H	577.4	1154.7	1200 (D/aM)	1000 (C/gG)	≤65	-	-
1000	TTFX1000	H	721.7	1443.4	1600 (D/aM)	1250 (C/gG)	≤65	-	-





TTF SERIES

Input 800 V +N · Output 400 V +N

Datos teóricos - modelo estándar

Power kVA	Reference	Insulation class	Current A		Protections A		Noise dB	Cable gland (TTDW) Stuffing boxes (TTDZ)	
			Input	Output	Input	Output		ø max. (mm)	Quantity
TTFW									
0,63	TTFW0.63	F	0.5	0.9	2 (D/aM)	1 (C/gG)	≤45	14	2
1	TTFW1	F	0.7	1.4	2 (D/aM)	1.6 (C/gG)	≤45	14	2
2	TTFW2	F	1.4	2.9	3 (D/aM)	3 (C/gG)	≤45	14	2
2,5	TTFW2.5	F	1.8	3.6	4 (D/aM)	3 (C/gG)	≤45	18	2
3,15	TTFW3.15	F	2.3	4.5	6 (D/aM)	4 (C/gG)	≤45	18	2
4	TTFW4	F	2.9	5.8	10 (D/aM)	5 (C/gG)	≤45	18	2
5	TTFW5	F	3.6	7.2	10 (D/aM)	6 (C/gG)	≤45	18	2
6,3	TTFW6.3	F	4.5	9.1	10 (D/aM)	10 (C/gG)	≤45	25	4
8	TTFW8	F	5.8	11.5	16 (D/aM)	12 (C/gG)	≤45	25	4
10	TTFW10	F	7.2	14.4	16 (D/aM)	16 (C/gG)	≤45	32	4
12,5	TTFW12.5	F	9.0	18.0	20 (D/aM)	16 (C/gG)	≤45	32	4
16	TTFW16	F	11.5	23.1	25 (D/aM)	20 (C/gG)	≤45	32	4
20	TTFW20	F	14.4	28.9	32 (D/aM)	25 (C/gG)	≤45	32	4
25	TTFW25	F	18.0	36.1	40 (D/aM)	32 (C/gG)	≤45	32	4
31,5	TTFW31.5	F	22.7	45.5	50 (D/aM)	40 (C/gG)	≤45	32	4
40	TTFW40	H	28.9	57.7	63 (D/aM)	50 (C/gG)	≤55	32	8
50	TTFW50	H	36.1	72.2	80 (D/aM)	63 (C/gG)	≤55	32	8
63	TTFW63	H	45.5	90.9	100 (D/aM)	80 (C/gG)	≤55	32	8
80	TTFW80	H	57.7	115.5	125 (D/aM)	100 (C/gG)	≤55	32	8
100	TTFW100	H	72.2	144.3	160 (D/aM)	125 (C/gG)	≤55	32	8
125	TTFW125	H	90.2	180.4	200 (D/aM)	160 (C/gG)	≤55	44	8
160	TTFW160	H	115.5	230.9	300 (D/aM)	200 (C/gG)	≤55	44	8
200	TTFW200	H	144.3	288.7	300 (D/aM)	250 (C/gG)	≤55	44	8
250	TTFW250	H	180.4	360.8	400 (D/aM)	300 (C/gG)	≤65	44	8
315	TTFW315	H	227.3	454.7	500 (D/aM)	400 (C/gG)	≤65	44	8
400	TTFW400	H	288.7	577.4	600 (D/aM)	500 (C/gG)	≤65	44	8
500	TTFW500	H	360.8	721.7	800 (D/aM)	630 (C/gG)	≤65	44	8
630	TTFW630	H	454.7	909.3	1000 (D/aM)	800 (C/gG)	≤65	44	8
800	TTFW800	H	577.4	1154.7	1200 (D/aM)	1000 (C/gG)	≤65	44	8
1000	TTFW1000	H	721.7	1443.4	1600 (D/aM)	1250 (C/gG)	≤65	44	8
TTFZ									
0,63	TTFZ0.63	F	0.5	0.9	2 (D/aM)	1 (C/gG)	≤45	10 - 14	2
1	TTFZ1	F	0.7	1.4	2 (D/aM)	1.6 (C/gG)	≤45	10 - 14	2
2	TTFZ2	F	1.4	2.9	3 (D/aM)	3 (C/gG)	≤45	10 - 14	2
2,5	TTFZ2.5	F	1.8	3.6	4 (D/aM)	3 (C/gG)	≤45	18 - 25	2
3,15	TTFZ3.15	F	2.3	4.5	6 (D/aM)	4 (C/gG)	≤45	18 - 25	2
4	TTFZ4	F	2.9	5.8	10 (D/aM)	5 (C/gG)	≤45	18 - 25	2
5	TTFZ5	F	3.6	7.2	10 (D/aM)	6 (C/gG)	≤45	18 - 25	2
6,3	TTFZ6.3	F	4.5	9.1	10 (D/aM)	10 (C/gG)	≤45	18 - 25	2
8	TTFZ8	F	5.8	11.5	16 (D/aM)	12 (C/gG)	≤45	18 - 25	2
10	TTFZ10	F	7.2	14.4	16 (D/aM)	16 (C/gG)	≤45	22 - 32	2
12,5	TTFZ12.5	F	9.0	18.0	20 (D/aM)	16 (C/gG)	≤45	22 - 32	2
16	TTFZ16	F	11.5	23.1	25 (D/aM)	20 (C/gG)	≤45	22 - 32	2
20	TTFZ20	F	14.4	28.9	32 (D/aM)	25 (C/gG)	≤45	22 - 32	2
25	TTFZ25	F	18.0	36.1	40 (D/aM)	32 (C/gG)	≤45	22 - 32	2
31,5	TTFZ31.5	F	22.7	45.5	50 (D/aM)	40 (C/gG)	≤45	22 - 32	2
40	TTFZ40	H	28.9	57.7	63 (D/aM)	50 (C/gG)	≤55	22 - 32	2
50	TTFZ50	H	36.1	72.2	80 (D/aM)	63 (C/gG)	≤55	22 - 32	2
63	TTFZ63	H	45.5	90.9	100 (D/aM)	80 (C/gG)	≤55	22 - 32	2
80	TTFZ80	H	57.7	115.5	125 (D/aM)	100 (C/gG)	≤55	22 - 32	2
100	TTFZ100	H	72.2	144.3	160 (D/aM)	125 (C/gG)	≤55	22 - 32	2
125	TTFZ125	H	90.2	180.4	200 (D/aM)	160 (C/gG)	≤55	34 - 44	2
160	TTFZ160	H	115.5	230.9	300 (D/aM)	200 (C/gG)	≤55	34 - 44	2
200	TTFZ200	H	144.3	288.7	300 (D/aM)	250 (C/gG)	≤55	34 - 44	2
250	TTFZ250	H	180.4	360.8	400 (D/aM)	300 (C/gG)	≤65	34 - 44	2
315	TTFZ315	H	227.3	454.7	500 (D/aM)	400 (C/gG)	≤65	34 - 44	2
400	TTFZ400	H	288.7	577.4	600 (D/aM)	500 (C/gG)	≤65	34 - 44	2
500	TTFZ500	H	360.8	721.7	800 (D/aM)	630 (C/gG)	≤65	34 - 44	2
630	TTFZ630	H	454.7	909.3	1000 (D/aM)	800 (C/gG)	≤65	34 - 44	2
800	TTFZ800	H	577.4	1154.7	1200 (D/aM)	1000 (C/gG)	≤65	34 - 44	2
1000	TTFZ1000	H	721.7	1443.4	1600 (D/aM)	1250 (C/gG)	≤65	34 - 44	2



TTF SERIES

Input **800 V +N** · Output **400 V +N**

Medidas

Power kVA	Reference	External dimensions mm			Fastening elements mm			Weight kg
		A	B	C	D	E	Ø	
TTFX								
0,63	TTFX0.63	150	94	178	66	125	6	5.9
1	TTFX1	180	94	203	76	150	6	9.5
2	TTFX2	240	145	253	125	200	9	20
2,5	TTFX2.5	300	124	303	115	250	9	23.9
3,15	TTFX3.15	300	134	303	125	250	9	27.4
4	TTFX4	300	154	303	145	250	9	36
5	TTFX5	300	164	303	155	250	9	40.4
6,3	TTFX6.3	360	144	353	122	300	11	55
8	TTFX8	360	164	353	142	300	11	67
10	TTFX10	420	170	419	136	350	11	78
12,5	TTFX12.5	420	190	419	156	350	11	94
16	TTFX16	480	250	480	144	400	11	105
20	TTFX20	480	270	480	164	400	11	125
25	TTFX25	480	290	480	184	400	11	145
31,5	TTFX31.5	480	310	480	204	400	11	162
40	TTFX40	670	280	615	170	426	13	191
50	TTFX50	670	300	615	190	426	13	233
63	TTFX63	670	320	690	210	426	13	277
80	TTFX80	670	340	690	230	426	13	320
100	TTFX100	670	360	690	250	426	13	368
125	TTFX125	785	550	880	460	472	17	462
160	TTFX160	785	550	880	460	472	17	560
200	TTFX200	785	550	880	460	472	17	660
250	TTFX250	1016	550	1080	460	690	17	808
315	TTFX315	1070	550	1220	460	690	17	1000
400	TTFX400	1070	550	1220	460	690	17	1092
500	TTFX500	1300	550	1350	460	800	17	1658
630	TTFX630	1300	600	1350	460	800	17	2000
800	TTFX800	1300	700	1350	600	800	17	2413
1000	TTFX1000	1300	800	1350	600	800	17	2993

Power kVA	Reference	External dimensions mm			Fastening elements mm			Weight kg
		A	B	C	D	E	Ø	
TTFW								
0,63	TTFW0.63	194	175	220	165	100	6	7.6
1	TTFW1	240	190	250	180	150	6	13.2
2	TTFW2	315	230	315	205	200	6	24.8
2,5	TTFW2.5	385	260	384	245	250	6	28.8
3,15	TTFW3.15	385	260	384	245	250	6	32.8
4	TTFW4	385	260	384	245	250	6	40.8
5	TTFW5	385	260	384	245	250	6	45.2
6,3	TTFW6.3	458	340	500	300	300	12	61
8	TTFW8	458	340	500	300	300	12	73
10	TTFW10	528	418	644	375	345	12	89
12,5	TTFW12.5	528	418	644	375	345	12	106
16	TTFW16	597	415	710	375	345	12	117
20	TTFW20	597	415	710	375	345	12	137
25	TTFW25	597	415	710	375	345	12	157
31,5	TTFW31.5	597	415	710	375	345	12	174
40	TTFW40	795	550	970	500	415	12	237
50	TTFW50	795	550	970	500	415	12	279
63	TTFW63	795	550	970	500	415	12	323
80	TTFW80	795	550	970	500	415	12	366
100	TTFW100	795	550	970	500	415	12	414
125	TTFW125	970	670	1250	582	470	18	514
160	TTFW160	970	670	1250	582	470	18	612
200	TTFW200	970	670	1250	582	470	18	754
250	TTFW250	1200	760	1555	672	690	18	855
315	TTFW315	1200	760	1555	672	690	18	1093
400	TTFW400	1200	760	1555	672	690	18	1185
500	TTFW500	1530	1000	1880	900	800	20	1808
630	TTFW630	1530	1000	1880	900	800	20	2149
800	TTFW800	1530	1000	1880	900	800	20	2563
1000	TTFW1000	1530	1000	1880	900	800	20	3143

TTFX IP00

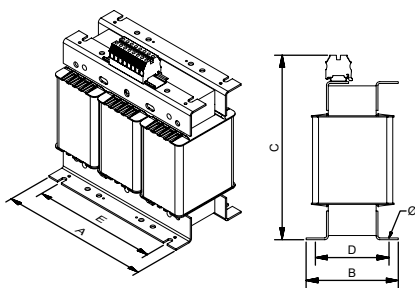

From 0,63 kVA to 12,5 kVA

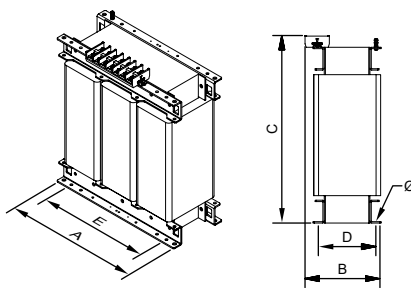

From 16 kVA to 200 kVA

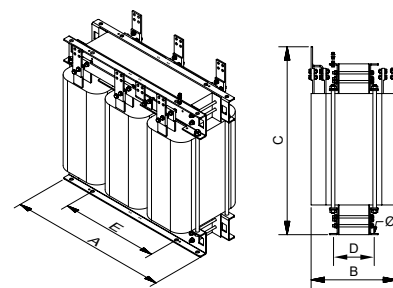

From 250 kVA

TTFW IP23

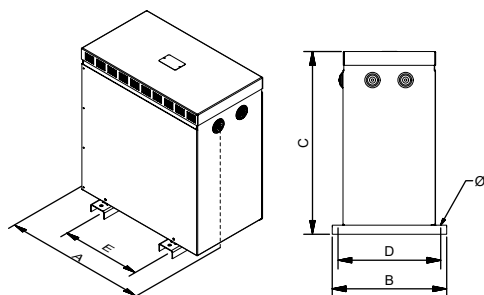

From 0,63 kVA to 31,5 kVA

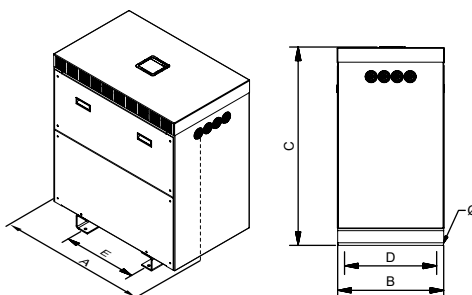

From 40 kVA



Sectioned





TTF SERIES

Input **800 V +N** · Output **400 V +N**

Medidas

Power kVA	Reference	External dimensions mm			Fastening elements mm			Weight kg
		A	B	C	D	E	Ø	
TTFZ								
0,63	TTFZ0.63	330	284	463	230	200	11	19.5
1	TTFZ1	330	284	463	230	200	11	24
2	TTFZ2	510	362	689	320	250	11	37
2,5	TTFZ2.5	510	362	689	320	250	11	40
3,15	TTFZ3.15	510	362	689	320	250	11	57
4	TTFZ4	510	362	689	320	250	11	61
5	TTFZ5	510	362	689	320	250	11	76
6,3	TTFZ6.3	510	362	689	320	250	11	87.5
8	TTFZ8	694	413	764	370	350	11	118
10	TTFZ10	694	413	764	370	350	11	134
12,5	TTFZ12.5	694	413	764	370	350	11	145
16	TTFZ16	694	413	764	370	350	11	165
20	TTFZ20	694	413	764	370	350	11	185
25	TTFZ25	694	413	764	370	350	11	202
31,5	TTFZ31.5	694	413	764	370	350	11	220
40	TTFZ40	890	560	1148	520	426	13	251
50	TTFZ50	890	560	1148	520	426	13	295
63	TTFZ63	890	560	1148	520	426	13	340
80	TTFZ80	890	560	1148	520	426	13	383
100	TTFZ100	890	560	1148	520	426	13	433
125	TTFZ125	972	740	1480	660	470	17	551
160	TTFZ160	972	740	1480	660	470	17	628
200	TTFZ200	972	740	1480	660	470	17	797
250	TTFZ250	1394	870	1762	810	690	17	1186
315	TTFZ315	1394	870	1762	810	690	17	1278
400	TTFZ400	1394	870	1762	810	690	17	1933
500	TTFZ500	1640	1226	1770	1110	800	17	2275
630	TTFZ630	1640	1226	1770	1110	800	17	2688
800	TTFZ800	1640	1226	1770	1110	800	17	3268
1000	TTFZ1000	1640	1226	1770	1110	800	17	3848

TTFZ IP54 / 65

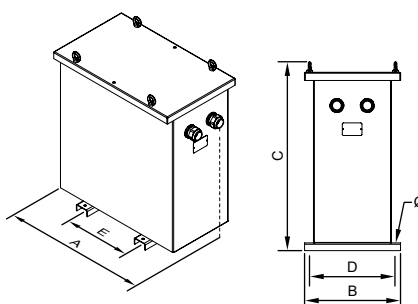



TTF SERIES

Input **800 V +N** · Output **400 V +N**

On-request manufacturing options (please see prices)

Power	From 0.15 kVA to 1000 kVA
Voltage	From 1 V to 12 kV
Windings	Copper or aluminium
Frequency	From 50 Hz to 400 Hz
Connection unit	Yyn0, Dyn11, Dd0, Dy1, Dyn5, YNd1/5/11... (See Technical Appendix T.A.2)
IP rating	IP00, IP20, IP23, IP31, IP42, IP54, IP55 and IP65
IK rating	IK08 and IK10
Room temperature	Up to 60 °C
Locks	Screw, key
Test voltage	Up to 28 kV
Short circuit voltage	From 2% to 9%
Losses	Low losses, ecological
Operation	Intermittent, continuous
Cooling	Natural, forced ventilation
Electrostatic shield	Up to three shields
Safety class	I, II
Altitude	Up to 4000 m
Protections	In both primary and secondary (figure 1)
Temperature sensors	PT100 (figure 2), PTC (figure 3) or bimetallic
Temperature control	Temperature control station (4xPT100) (figure 4), PTC thermal relays (3xPTC / 6xPTC)
Network analyser	(Figure 5)
Anti condensation system	Higrostat
Heating system	Heating elements
External protection	Anti-flash varnish, resin encapsulated, metal or stainless steel enclosure
Transportation and hoisting	Wheels (figure 6), lifting points
Paint	C3, C4, C5, different RAL
Feature plate	High generation polymer or stainless steel (figure 7)
Anti vibration system	Silentblock
Adjustment	-10%; -7.5%; -5%; -2.5%; +2.5%; +5%; +7.5%; +10% With bridges (figure 8) or selector (figure 9)
Certified	CE, DNV-GL, BV, UL (insulation) and POLYLUX laboratory
Climate class / environment / fire	Up to C2-E2-F1



Figure 1



Figure 2



Figure 3



Figure 4



Figure 5



Figure 6



Figure 7



Figure 8



Figure 9



TTF SERIES

Input **800 V +N** · Output **400 V +N**

Feature plate structure

Plastic label up to 31,5 kVA:

POLYLUX®		CE		CE declaration of conformity
Power (kVA)	XXX kVA	PRI:	400 V <small>XXX A</small>	Primary voltage
Reference	<small>TTFXXX</small>	SEC:	400 V <small>XXX A</small>	Primary current
Frequency	<small>50 - 60 Hz</small>	Insulation transformer symbol	IP-XX	Secondary voltage
	Yyn0	Insulators	EN 61558	Secondary current
Connection unit	SN: TTFXXXXXXX <small>Made in Spain</small>	Test voltage	3kV	IP rating
Serial number	9 638 456 958 502	Applicable standard	EN 61558	EAN bar code

Stainless steel label from 40 kVA:

POLYLUX®		<small>www.polylux.com</small>		Insulators
Performance	XXX kVA	PRI:	XXX V <small>XXX A</small>	Test voltage
Short circuit voltage	XXX kVA	SEC:	XXX V <small>XXX A</small>	Primary voltage
Power (kVA)	XXX kVA	Insulation transformer symbol	IEC 60076	Primary current
Frequency	<small>50 - 60 Hz</small>	Connection unit	IP-XX	Secondary voltage
	Yyn0	CE declaration of conformity	3 kV	Secondary current
Losses in short circuit	CE <small>Made in Spain</small>	Losses when empty	η = XX %	Applicable standard
	P_{cc} = XXX W	Losses when empty	U_{cc} = X %	Protection rating
	P₀ = XXX W	Weight	ANXX	Cooling
	SN: TTFXXXXXXX	Reference	XXXX kg	Weight
	TTFXXXXXXX	Serial number	TTFXXXXXXX	Serial number



TTK SERIES

Isolation three-phase to single-phase · three-phase **input 400 V** · Single-phase **output 230 V**

Definition and applications

Transformers for applications in which there is very high single-phase consumption in an installation and the load is to be shared in a three-phase system to prevent important imbalances. It should be mentioned that due to the way in which they operate, this type of transformer does not achieve a totally balanced load in primary. The current in the central primary phase may be double the nominal current. It is advisable to use these transformers for powers higher than 5kVA as it is understood that in most industrial installations, for consumptions equal to or less than this power, it will not entail a considerable consumption load. For powers equal to or less than 5kVA, use the conventional single-phase "PD", "QD", "ND" or "TK" series transformers.

Manufacturing characteristics

- All the transformers are dipped in anti-flash varnish and then compacted in the furnace. This process increases the insulation grade, reduces noise and provides anti-moisture, waterproofed protection.
- The high power transformers are manufactured with format cores and low loss properties, thus contributing to improving performance.
- All the transformers are checked automatically one by one and the compliance test report is created in accordance with the corresponding standard.



TTKX

- IP00 protection rating.
- Power from 1 kVA to 100 kVA.
- Total impregnated in anti-flash varnish.
- Hoisting elements included.



TTKZ

- IP54 rating / 65 (IK10).
- Power from 1 kVA to 100 kVA.
- Metal box painted with RAL7035 polyester resin.
- High resistance to corrosion.
- Stuffing box cover for cable input depending on installation needs.
- Hoisting elements included.
- Detachable top cover.
- With silentblock.



TTKW

- IP23 rating (IK08).
- Power from 1 kVA to 100 kVA.
- Metal box painted with RAL7035 polyester resin.
- High resistance to corrosion.
- Hoisting elements included.
- Detachable top and front cover.
- Cable outlet with cable gland.

Technical features - standard model

Power	1 kVA to 100 kVA
Standard voltage	Three-phase 400 V input// Single-phase 230 V output
Standard frequency	50-60 Hz
Windings	Class HC-200 °C
Insulators	Class F - 155 °C ≤ 40 kVA (25 kVA TTKZ) Class H - 180 °C ≥ 50 kVA (31.5 kVA TTKZ) <small>*More information in Technical Appendix (T.A.1)</small>
Class	I
Altitude	1000 m
Enclosure colour	RAL 7035
IP rating	IP00 (TTKX) IP23 (TTKW) IP54 / 65 (TTKZ)
IK rating	IK08 (TTKW)
Paint class (ISO 12944)	C3 (TTKW) C4 (TTKZ)
Room temperature	45 °C
Standards	IEC/EN/UNE-EN 61558, CE
Test voltage	3 kV (1 min., 50 Hz)
Inrush	< 12 In
Ucc	≤ 4 %
K factor	4
Operation	Continuous
Cooling	AN (TTKX) - ANAN (TTKW-TTKZ)

Electrical diagram

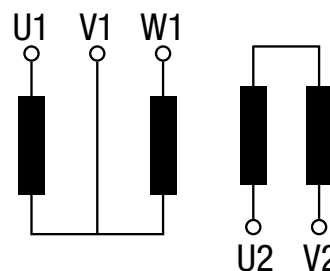

Connection

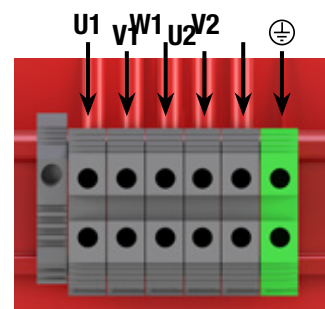



TTK SERIES

Isolation three-phase to single-phase · three-phase input 400 V · Single-phase output 230 V

Terminal types

Terminals		Maximum cross-section conductor mm ²	Maximum tightening torque		TTKX-TTKW-TTKZ			
					Power kVA			
					Input		Output	
			N-m	Lb-In	From	To	From	To
Power strip 1	Terminal 10	16	1.2	10.6	1	1.6	1	1.6
	Terminal 16	25	1.2	10.6	2	5	2	5
	Terminal 35	50	2.5	22.1	6.3	10	6.3	10
Power strip 2	Terminal 60	25	4.5	40	12.5	40	12.5	12.5
	Terminal 100	35	6.7	60	50	63	16	25
	Terminal 200	95	9	80	80	80	31.5	40
	Terminal 300	150	9	80	-	-	50	80
Connection plate	Plate 30 X 1	150	-	-	100	100	-	-
	Plate 50 X 1	150	-	-	-	-	100	100

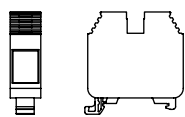

Power strip 1

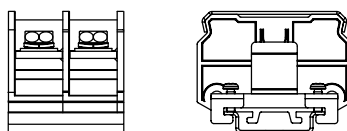

Power strip 2

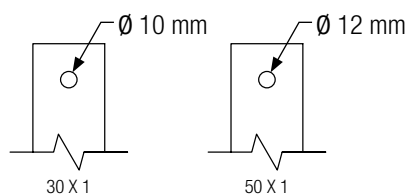

Plate connection

Theoretical data - standard model

Power kVA	Reference	Insulation class	Current A		Protections A		Noise dB
			Input	Output	Input	Output	
TTKX							
1	TTKX1	F	1.4	4.3	3 (D/Am)	4 (C/gG)	≤45
1.6	TTKX1.6	F	2.3	7.0	6 (D/Am)	7 (C/gG)	≤45
2	TTKX2	F	2.9	8.7	10 (D/Am)	8 (C/gG)	≤45
2.5	TTKX2.5	F	3.6	10.9	10 (D/Am)	10 (C/gG)	≤45
3.15	TTKX3.15	F	4.5	13.7	10 (D/Am)	12 (C/gG)	≤45
4	TTKX4	F	5.8	17.4	16 (D/Am)	12 (C/gG)	≤45
5	TTKX5	F	7.2	21.7	16 (D/Am)	20 (C/gG)	≤45
6.3	TTKX6.3	F	9.1	27.4	20 (D/Am)	25 (C/gG)	≤45
8	TTKX8	F	11.5	34.8	25 (D/Am)	30 (C/gG)	≤45
10	TTKX10	F	14.4	43.5	32 (D/Am)	40 (C/gG)	≤45
12.5	TTKX12.5	F	18.0	54.3	40 (D/Am)	50 (C/gG)	≤45
16	TTKX16	F	23.1	69.6	50 (D/Am)	60 (C/gG)	≤45
20	TTKX20	F	28.9	87.0	63 (D/Am)	80 (C/gG)	≤45
25	TTKX25	F	36.1	108.7	80 (D/Am)	100 (C/gG)	≤45
31.5	TTKX31.5	F	45.5	137.0	100 (D/Am)	100 (C/gG)	≤45
40	TTKX40	F	57.7	173.9	125 (D/Am)	160 (C/gG)	≤55
50	TTKX50	H	72.2	217.4	160 (D/Am)	200 (C/gG)	≤55
63	TTKX63	H	90.9	273.9	200 (D/Am)	200 (C/gG)	≤55
80	TTKX80	H	115.5	347.8	300 (D/Am)	300 (C/gG)	≤55
100	TTKX100	H	144.3	434.8	300 (D/Am)	400 (C/gG)	≤55



TTK SERIES

Isolation three-phase to single-phase · three-phase input 400 V · Single-phase output 230 V

Theoretical data - standard model

Power kVA	Reference	Insulation class	Current A		Protections A		Noise dB	Cable gland (TTKW) / Stuffing boxes (TTKZ)	
			Input	Output	Input	Output		∅ max. (mm)	Quantity
TTKW									
1	TTKW1	F	1.4	4.3	3 (D/Am)	4 (C/gG)	≤45	14	2
1.6	TTKW1.6	F	2.3	7.0	6 (D/Am)	7 (C/gG)	≤45	14	2
2	TTKW2	F	2.9	8.7	10 (D/Am)	8 (C/gG)	≤45	18	2
2.5	TTKW2.5	F	3.6	10.9	10 (D/Am)	10 (C/gG)	≤45	18	2
3.15	TTKW3.15	F	4.5	13.7	10 (D/Am)	12 (C/gG)	≤45	18	2
4	TTKW4	F	5.8	17.4	16 (D/Am)	12 (C/gG)	≤45	18	2
5	TTKW5	F	7.2	21.7	16 (D/Am)	20 (C/gG)	≤45	25	4
6.3	TTKW6.3	F	9.1	27.4	20 (D/Am)	25 (C/gG)	≤45	25	4
8	TTKW8	F	11.5	34.8	25 (D/Am)	30 (C/gG)	≤45	32	4
10	TTKW10	F	14.4	43.5	32 (D/Am)	40 (C/gG)	≤45	32	4
12.5	TTKW12.5	F	18.0	54.3	40 (D/Am)	50 (C/gG)	≤45	32	4
16	TTKW16	F	23.1	69.6	50 (D/Am)	60 (C/gG)	≤45	32	4
20	TTKW20	F	28.9	87.0	63 (D/Am)	80 (C/gG)	≤45	32	4
25	TTKW25	F	36.1	108.7	80 (D/Am)	100 (C/gG)	≤45	32	8
31.5	TTKW31.5	F	45.5	137.0	100 (D/Am)	100 (C/gG)	≤45	32	8
40	TTKW40	F	57.7	173.9	125 (D/Am)	160 (C/gG)	≤55	32	8
50	TTKW50	H	72.2	217.4	160 (D/Am)	200 (C/gG)	≤55	44	8
63	TTKW63	H	90.9	273.9	200 (D/Am)	200 (C/gG)	≤55	44	8
80	TTKW80	H	115.5	347.8	300 (D/Am)	300 (C/gG)	≤55	44	8
100	TTKW100	H	144.3	434.8	300 (D/Am)	400 (C/gG)	≤55	44	8
TTKZ									
1	TTKZ1	F	1.4	4.3	3 (D/Am)	4 (C/gG)	≤45	10 - 14	2
1.6	TTKZ1.6	F	2.3	7.0	6 (D/Am)	7 (C/gG)	≤45	18 - 25	2
2	TTKZ2	F	2.9	8.7	10 (D/Am)	8 (C/gG)	≤45	18 - 25	2
2.5	TTKZ2.5	F	3.6	10.9	10 (D/Am)	10 (C/gG)	≤45	18 - 25	2
3.15	TTKZ3.15	F	4.5	13.7	10 (D/Am)	12 (C/gG)	≤45	18 - 25	2
4	TTKZ4	F	5.8	17.4	16 (D/Am)	12 (C/gG)	≤45	18 - 25	2
5	TTKZ5	F	7.2	21.7	16 (D/Am)	20 (C/gG)	≤45	18 - 25	2
6.3	TTKZ6.3	F	9.1	27.4	20 (D/Am)	25 (C/gG)	≤45	22 - 32	2
8	TTKZ8	F	11.5	34.8	25 (D/Am)	30 (C/gG)	≤45	22 - 32	2
10	TTKZ10	F	14.4	43.5	32 (D/Am)	40 (C/gG)	≤45	22 - 32	2
12.5	TTKZ12.5	F	18.0	54.3	40 (D/Am)	50 (C/gG)	≤45	22 - 32	2
16	TTKZ16	F	23.1	69.6	50 (D/Am)	60 (C/gG)	≤45	22 - 32	2
20	TTKZ20	F	28.9	87.0	63 (D/Am)	80 (C/gG)	≤45	22 - 32	2
25	TTKZ25	F	36.1	108.7	80 (D/Am)	100 (C/gG)	≤45	22 - 32	2
31.5	TTKZ31.5	H	45.5	137.0	100 (D/Am)	100 (C/gG)	≤45	22 - 32	2
40	TTKZ40	H	57.7	173.9	125 (D/Am)	160 (C/gG)	≤55	22 - 32	2
50	TTKZ50	H	72.2	217.4	160 (D/Am)	200 (C/gG)	≤55	34 - 44	2
63	TTKZ63	H	90.9	273.9	200 (D/Am)	200 (C/gG)	≤55	34 - 44	2
80	TTKZ80	H	115.5	347.8	300 (D/Am)	300 (C/gG)	≤55	34 - 44	2
100	TTKZ100	H	144.3	434.8	300 (D/Am)	400 (C/gG)	≤55	34 - 44	2



TTK SERIES

Isolation three-phase to single-phase · three-phase input 400 V · Single-phase output 230 V

Measurements

Power kVA	Reference	External dimensions mm			Fastening elements mm			Weight kg
		A	B	C	D	E	∅	
TTKX								
1	TTKX1	260	118	253	94	200	9	14.1
1.6	TTKX1.6	260	143	253	119	200	9	20.4
2	TTKX2	330	124	303	115	250	9	23.3
2.5	TTKX2.5	330	134	303	125	250	9	27.8
3.15	TTKX3.15	330	154	303	145	250	9	35.2
4	TTKX4	330	164	303	155	250	9	40
5	TTKX5	400	144	353	122	300	11	48
6.3	TTKX6.3	400	164	353	142	300	11	58
8	TTKX8	470	170	419	136	350	11	72
10	TTKX10	470	190	419	156	350	11	88
12.5	TTKX12.5	530	260	480	154	400	11	112
16	TTKX16	530	290	480	184	400	11	139
20	TTKX20	530	310	480	204	400	11	164
25	TTKX25	740	290	580	170	426	13	191
31.5	TTKX31.5	740	310	580	190	426	13	234
40	TTKX40	740	330	580	210	426	13	277
50	TTKX50	785	550	880	460	472	17	340
63	TTKX63	785	550	880	460	472	17	394
80	TTKX80	785	550	880	460	472	17	436
100	TTKX100	785	550	880	460	472	17	507

Power kVA	Reference	External dimensions mm			Fastening elements mm			Weight kg
		A	B	C	D	E	∅	
TTKW								
1	TTKW1	315	230	315	205	200	6	18.4
1.6	TTKW1.6	315	230	315	205	200	6	24.7
2	TTKW2	385	260	384	245	250	6	28.1
2.5	TTKW2.5	385	260	384	245	250	6	32.6
3.15	TTKW3.15	385	260	384	245	250	6	40
4	TTKW4	385	260	384	245	250	6	44.8
5	TTKW5	458	340	500	300	300	12	54
6.3	TTKW6.3	458	340	500	300	300	12	64
8	TTKW8	528	418	644	375	345	12	84
10	TTKW10	528	418	644	375	345	12	100
12.5	TTKW12.5	597	415	710	375	345	12	124
16	TTKW16	597	415	710	375	345	12	151
20	TTKW20	597	415	710	375	345	12	176
25	TTKW25	795	550	970	500	415	12	216
31.5	TTKW31.5	795	550	970	500	415	12	259
40	TTKW40	795	550	970	500	415	12	302
50	TTKW50	795	550	970	500	415	12	392
63	TTKW63	795	550	970	500	415	12	446
80	TTKW80	970	670	1250	582	470	18	488
100	TTKW100	970	670	1250	582	470	18	559

TTKX IP00

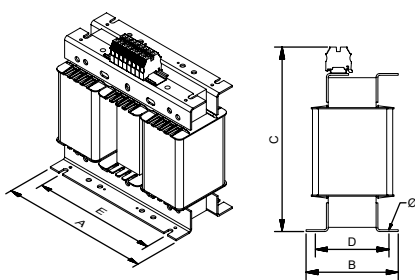

From 1 kVA to 12.5 kVA

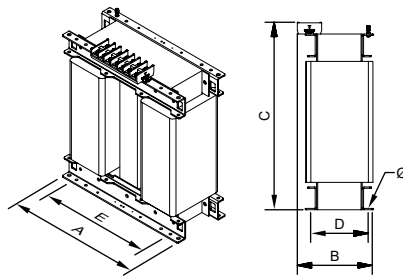

From 12.5 kVA to 63 kVA

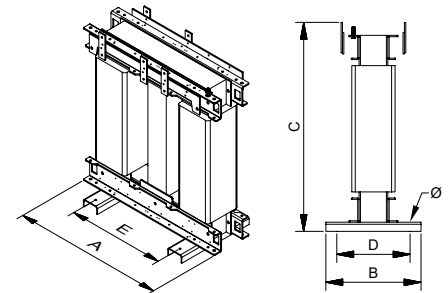

From 80 kVA

TTKW IP23

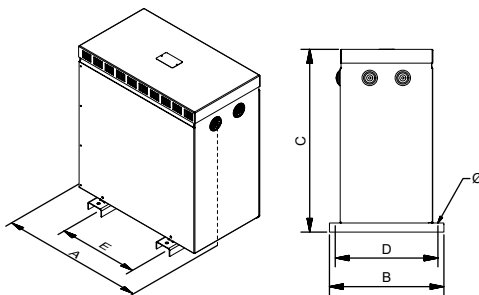

From 1 kVA to 20 kVA

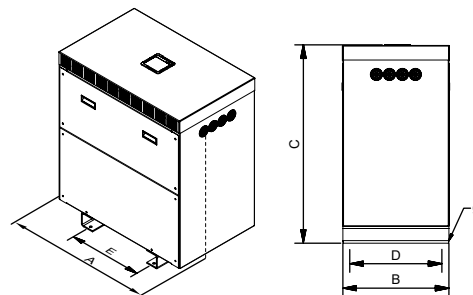

From 25 kVA



TTK SERIES

Isolation three-phase to single-phase · three-phase input 400 V · Single-phase output 230 V

Measurements

Power kVA	Reference	External dimensions mm			Fastening elements mm			Weight kg
		A	B	C	D	E	∅	
TTKZ								
1	TTKZ1	330	284	463	230	200	11	33.4
1.6	TTKZ1.6	510	362	689	320	250	11	44.3
2	TTKZ2	510	362	689	320	250	11	48.8
2.5	TTKZ2.5	510	362	689	320	250	11	56
3.15	TTKZ3.15	510	362	689	320	250	11	61
4	TTKZ4	510	362	689	320	250	11	69
5	TTKZ5	510	362	689	320	250	11	79
6.3	TTKZ6.3	694	413	764	370	350	11	112
8	TTKZ8	694	413	764	370	350	11	128
10	TTKZ10	694	413	764	370	350	11	152
12.5	TTKZ12.5	694	413	764	370	350	11	179
16	TTKZ16	694	413	764	370	350	11	204
20	TTKZ20	890	560	1148	520	426	13	256
25	TTKZ25	890	560	1148	520	426	13	299
31.5	TTKZ31.5	890	560	1148	520	426	13	342
40	TTKZ40	890	560	1148	520	426	13	469
50	TTKZ50	890	560	1148	520	426	13	523
63	TTKZ63	972	740	1480	660	470	17	565
80	TTKZ80	972	740	1480	660	470	17	636
100	TTKZ100	972	740	1480	660	470	17	657

TTKZ IP54 / 65

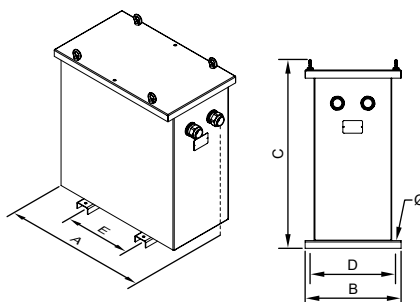



TTK SERIES

Isolation three-phase to single-phase · three-phase input 400 V · Single-phase output 230 V

On-request manufacturing options (please see prices)

Power	From 1 kVA to 100 kVA
Windings	Copper or aluminium
Frequency	From 50 Hz to 400 Hz
IP rating	IP00, IP20, IP23, IP31, IP42, IP54, IP55 and IP65
IK rating	IK08 and IK10
Room temperature	Up to 60 °C
Locks	Screw, key
Test voltage	Up to 28 kV
Short circuit voltage	From 2% to 9%
Operation	Intermittent, continuous
Cooling	Natural, forced ventilation
Electrostatic shield	Up to three shields
Class	I, II
Altitude	Up to 4000 m
Protections	In both primary and secondary (figure 1)
Temperature sensors	PT100 (figure 2), PTC (figure 3) or bimetallic
Temperature control	Temperature control station (4xPT100) (figure 4), PTC thermal relays (3xPTC / 6xPTC)
Network analyser	(Figure 5)
Anti condensation system	Higrostat
Heating system	Heating elements
External protection	Anti-flash varnish, metallic or stainless steel enclosure
Transportation and hoisting	Wheels (figure 6), lifting points
Paint	C3, C4, C5, different RAL
Feature plate	High generation polymer or stainless steel (figure 7)
Anti vibration system	Silentblock
Adjustment	-10%; -7.5%; -5%; -2.5%; +2.5%; +5%; +7.5%; +10% With bridges (figure 8) or selector (figure 9)
Certified	CE, DNV-GL, BV, UL (insulation) and POLYLUX laboratory
Climate class / environment / fire	Up to C2-E2-F1



Figure 1



Figure 2



Figure 3



Figure 4



Figure 5



Figure 6



Figure 7



Figure 8



Figure 9



TTK SERIES

Isolation three-phase to single-phase · three-phase input 400 V · Single-phase output 230 V

Feature plate structure

Plastic label up to 20 kVA:

POLYLUX®		CE		CE declaration of conformity
Power (kVA)	XXX kVA	PRI:	400 V <small>XXX A</small>	Primary voltage
Reference	<small>TTKXXX</small>	SEC:	230 V <small>XXX A</small>	Primary current
Frequency	<small>50 - 60 Hz</small>	<small>F-155°C</small>	<small>IP-XX</small>	Secondary voltage
Insulation transformer symbol		<small>V/Vin</small>	<small>3kV</small>	Secondary current
Connection unit	<small>SN: TTKXXXXXXXX</small>	<small>EN 61558</small>		IP rating
Serial number	<small>Made in Spain</small>	<small>9 638 456 958 502</small>		Applicable standard
				EAN bar code
				Test voltage
				Insulators

Stainless steel label from 25 kVA:

POLYLUX®		<small>www.polylux.com</small>		Insulators
Performance	XXX kVA	PRI:	400 V <small>XXX A</small>	Test voltage
Short circuit voltage	<small>TTKXXX</small>	SEC:	230 V <small>XXX A</small>	Primary voltage
Power (kVA)	<small>50 - 60 Hz</small>	<small>H-180°C</small>	<small>EN 61558</small>	Primary current
Frequency		<small>V/Vin</small>	<small>IP-XX</small>	Secondary voltage
Insulation transformer symbol	<small>Pcc= XXX W</small>	<small>η= XX %</small>	<small>ANXX</small>	Secondary current
Connection unit	<small>Po= XXX W</small>	<small>Ucc= X %</small>	<small>XXXX kg</small>	Applicable standard
CE declaration of conformity	CE	<small>TTKXXX</small>		Protection rating
Losses in short circuit	<small>Made in Spain</small>	<small>SN:</small>	<small>TTKXXXXXXXX</small>	Cooling
Losses when empty				Weight
				Reference
				Serial number



TTG SERIES

Ecological three-phase isolation · Input **400 V** · Output **400 V + N**

Definition and applications

Our TTG series are three-phase isolation transformers with low losses designed to operate continuously at maximum output.

Applications:

- Circuit isolation, with the possibility of increasing or reducing the voltage.
- Reducing voltage drops in installations with long cable lengths. With the installation of a step-up transformer and a reducer transformer.
- In installations with a certain level of electrical noise, the TTG series helps improve the electrical network quality in secondary.
- Changing the neutral system of an installation.
- In installations where energy savings is critical, or where a lower connection peak is required such as renewable energy plants or high energy efficiency installations.



TTGX

- IP00 protection rating.
- Power from 10 kVA to 400 kVA.
- Total impregnated in anti-flash varnish.
- Hoisting elements included.

Manufacturing characteristics

- All the transformers are dipped in anti-flash varnish and then compacted in the furnace. This process increases the insulation grade, reduces noise and provides anti-moisture, waterproofed protection.
- All the transformers are made to provide a high performance and lower losses than standard transformers. This high performance makes it possible to cut operating costs, providing great energy savings and thus helping to protect the environment.
- All the transformers are checked automatically one by one and the compliance test report is created in accordance with the corresponding standard.



TTGW

- IP23 rating (IK08).
- Power from 10 kVA to 400 kVA.
- Metal box painted with RAL7035 polyester resin.
- High resistance to corrosion.
- Cable outlet with cable gland.
- Hoisting elements included.
- Detachable top and front cover.



TTGZ

- IP54 rating / 65 (IK10).
- Power from 10 kVA to 400 kVA.
- Metal box painted with RAL7035 polyester resin.
- High resistance to corrosion.
- Stuffing box cover for cable input depending on installation needs.
- Hoisting elements included.
- Detachable top cover.
- With silentblock.

Technical features - standard model

Power	10 kVA to 400 kVA
Standard voltage	Input 400 V // Output 400 V and N.
Standard frequency	50-60 Hz
Connection unit	Yyn0
Windings	Class HC-200 °C
Insulators	Class F - 155 °C ≤ 40 kVA Class H - 180 °C ≥ 50 kVA <small>*More information in Technical Appendix (T.A.1)</small>
Class	I
Altitude	1000 m
Enclosure colour	RAL 7035
IP rating	IP00 (TTGX) IP23 (TTGW) IP54 / 65 (TTGZ)
IK rating	IK08 (TTGW) IK10 (TTGZ)
Paint class (ISO 12944)	C3 (TTGW) C4 (TTGZ)
Room temperature	45 °C
Standards	IEC/EN 61558, CE up to 31.5 kVA IEC/EN 60076, CE from 40 kVA
Test voltage	3 kV (1 min., 50 Hz)
Inrush	< 5 In
Ucc	≤ 2 %
K factor	4
Operation	Continuous
Cooling	AN (TTGX) - ANAN (TTGW / TTGZ)

Electrical diagram

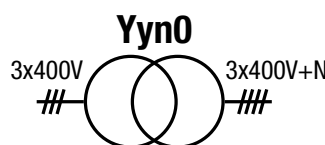
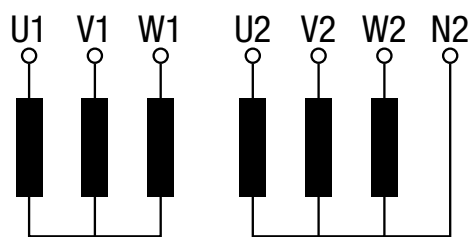

Connection

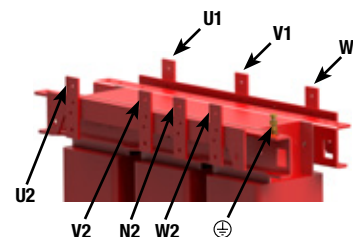
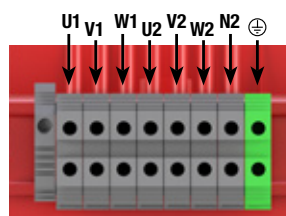



TTG SERIES

Ecological three-phase isolation · Input **400 V** · Output **400 V + N**

Terminal types

Terminals	Maximum cross-section conductor mm ²	Maximum tightening torque		TTGX-TTGW		TTGZ		
				Power kVA		Power kVA		
		N·m	Lb·In	From	To	From	To	
Power strip 1	Terminal 16	25	1.2	10.6	10	12.5	10	10
Power strip 2	Terminal 60	25	4.5	40	16	40	12.5	40
	Terminal 100	35	6.7	60	50	63	50	63
	Terminal 200	95	9	80	80	125	80	125
	Terminal 300	150	9	80	160	200	160	200
Connection plate	Plate 50 X 1	2x150	-	-	250	400	250	400

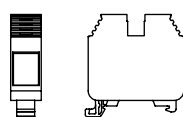

Power strip 1

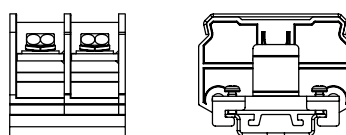

Power strip 2

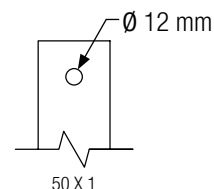

Plate connection

Theoretical data - standard model

Power kVA	Reference	Insulation class	Current A		Protections A		Noise dB
			Input	Output	Input	Output	
TTGX							
10	TTGX10	F	14.4	14.4	32 (D/Am)	12 (C/gG)	≤45
12.5	TTGX12.5	F	18.0	18.0	40 (D/Am)	12 (C/gG)	≤45
16	TTGX16	F	23.1	23.1	50 (D/Am)	20 (C/gG)	≤45
20	TTGX20	F	28.9	28.9	63 (D/Am)	25 (C/gG)	≤45
25	TTGX25	F	36.1	36.1	80 (D/Am)	30 (C/gG)	≤45
31.5	TTGX31.5	F	45.5	45.5	100 (D/Am)	40 (C/gG)	≤45
40	TTGX40	F	57.7	57.7	125 (D/Am)	50 (C/gG)	≤45
50	TTGX50	H	72.2	72.2	160 (D/Am)	60 (C/gG)	≤55
63	TTGX63	H	90.9	90.9	200 (D/Am)	80 (C/gG)	≤55
80	TTGX80	H	115.5	115.5	300 (D/Am)	100 (C/gG)	≤55
100	TTGX100	H	144.3	144.3	300 (D/Am)	100 (C/gG)	≤55
125	TTGX125	H	180.4	180.4	400 (D/Am)	160 (C/gG)	≤55
160	TTGX160	H	230.9	230.9	500 (D/Am)	200 (C/gG)	≤55
200	TTGX200	H	288.7	288.7	600 (D/Am)	250 (C/gG)	≤55
250	TTGX250	H	360.8	360.8	800 (D/Am)	300 (C/gG)	≤65
315	TTGX315	H	454.7	454.7	1000 (D/Am)	400 (C/gG)	≤65
400	TTGX400	H	577.4	577.4	1200 (D/Am)	500 (C/gG)	≤65



TTG SERIES

Ecological three-phase isolation · Input 400 V · Output 400 V + N

Theoretical data - standard model

Power kVA	Reference	Insulation class	Current A		Protections A		Noise dB	Cable gland (TTGW) / Stuffing boxes (TTGZ)	
			Input	Output	Input	Output		ø max. (mm)	Quantity
TTGW									
10	TTGW10	F	14.4	14.4	32 (D/Am)	12 (C/gG)	≤45	25	4
12.5	TTGW12.5	F	18.0	18.0	40 (D/Am)	12 (C/gG)	≤45	32	4
16	TTGW16	F	23.1	23.1	50 (D/Am)	20 (C/gG)	≤45	32	4
20	TTGW20	F	28.9	28.9	63 (D/Am)	25 (C/gG)	≤45	32	4
25	TTGW25	F	36.1	36.1	80 (D/Am)	30 (C/gG)	≤45	32	4
31.5	TTGW31.5	F	45.5	45.5	100 (D/Am)	40 (C/gG)	≤45	32	4
40	TTGW40	F	57.7	57.7	125 (D/Am)	50 (C/gG)	≤45	32	4
50	TTGW50	H	72.2	72.2	160 (D/Am)	60 (C/gG)	≤55	32	8
63	TTGW63	H	90.9	90.9	200 (D/Am)	80 (C/gG)	≤55	32	8
80	TTGW80	H	115.5	115.5	300 (D/Am)	100 (C/gG)	≤55	32	8
100	TTGW100	H	144.3	144.3	300 (D/Am)	100 (C/gG)	≤55	32	8
125	TTGW125	H	180.4	180.4	400 (D/Am)	160 (C/gG)	≤55	44	8
160	TTGW160	H	230.9	230.9	500 (D/Am)	200 (C/gG)	≤55	44	8
200	TTGW200	H	288.7	288.7	600 (D/Am)	250 (C/gG)	≤55	44	8
250	TTGW250	H	360.8	360.8	800 (D/Am)	300 (C/gG)	≤65	44	8
315	TTGW315	H	454.7	454.7	1000 (D/Am)	400 (C/gG)	≤65	44	8
400	TTGW400	H	577.4	577.4	1200 (D/Am)	500 (C/gG)	≤65	44	8
TTGZ									
10	TTGZ10	F	14.4	14.4	32 (D/Am)	12 (C/gG)	≤45	22 - 32	2
12.5	TTGZ12.5	F	18.0	18.0	40 (D/Am)	12 (C/gG)	≤45	22 - 32	2
16	TTGZ16	F	23.1	23.1	50 (D/Am)	20 (C/gG)	≤45	22 - 32	2
20	TTGZ20	F	28.9	28.9	63 (D/Am)	25 (C/gG)	≤45	22 - 32	2
25	TTGZ25	F	36.1	36.1	80 (D/Am)	30 (C/gG)	≤45	22 - 32	2
31.5	TTGZ31.5	F	45.5	45.5	100 (D/Am)	40 (C/gG)	≤45	22 - 32	2
40	TTGZ40	F	57.7	57.7	125 (D/Am)	50 (C/gG)	≤45	22 - 32	2
50	TTGZ50	H	72.2	72.2	160 (D/Am)	60 (C/gG)	≤55	22 - 32	2
63	TTGZ63	H	90.9	90.9	200 (D/Am)	80 (C/gG)	≤55	22 - 32	2
80	TTGZ80	H	115.5	115.5	300 (D/Am)	100 (C/gG)	≤55	22 - 32	2
100	TTGZ100	H	144.3	144.3	300 (D/Am)	100 (C/gG)	≤55	34 - 44	2
125	TTGZ125	H	180.4	180.4	400 (D/Am)	160 (C/gG)	≤55	34 - 44	2
160	TTGZ160	H	230.9	230.9	500 (D/Am)	200 (C/gG)	≤55	34 - 44	2
200	TTGZ200	H	288.7	288.7	600 (D/Am)	250 (C/gG)	≤55	34 - 44	2
250	TTGZ250	H	360.8	360.8	800 (D/Am)	300 (C/gG)	≤65	34 - 44	2
315	TTGZ315	H	454.7	454.7	1000 (D/Am)	400 (C/gG)	≤65	34 - 44	2
400	TTGZ400	H	577.4	577.4	1200 (D/Am)	500 (C/gG)	≤65	34 - 44	2



TTG SERIES

Ecological three-phase isolation · Input 400 V · Output 400 V + N

Measurements

Power kVA	Reference	External dimensions mm			Fastening elements mm			Weight kg
		A	B	C	D	E	Ø	
TTGX								
10	TTGX10	360	164	353	142	300	11	73
12.5	TTGX12.5	420	170	419	136	350	11	90
16	TTGX16	420	190	419	156	350	11	113
20	TTGX20	480	250	480	144	400	11	152
25	TTGX25	480	270	480	164	400	11	166
31.5	TTGX31.5	480	290	480	184	400	11	198
40	TTGX40	480	310	480	204	400	11	212
50	TTGX50	670	300	615	190	426	13	233
63	TTGX63	670	320	690	210	426	13	277
80	TTGX80	670	340	690	230	426	13	320
100	TTGX100	670	360	690	230	426	13	368
125	TTGX125	785	550	880	460	472	17	498
160	TTGX160	785	550	880	460	472	17	534
200	TTGX200	1016	550	1080	460	690	17	745
250	TTGX250	1016	550	1080	460	690	17	859
315	TTGX315	1070	550	1220	460	690	17	1001
400	TTGX400	1070	550	1220	460	690	17	1096

Power kVA	Reference	External dimensions mm			Fastening elements mm			Weight kg
		A	B	C	D	E	Ø	
TTGW								
10	TTGW10	458	340	500	300	300	12	79
12.5	TTGW12.5	528	418	644	375	345	12	102
16	TTGW16	528	418	644	375	345	12	125
20	TTGW20	597	415	710	375	345	12	164
25	TTGW25	597	415	710	375	345	12	178
31.5	TTGW31.5	597	415	710	375	345	12	210
40	TTGW40	597	415	710	375	345	12	224
50	TTGW50	795	550	970	500	415	12	279
63	TTGW63	795	550	970	500	415	12	323
80	TTGW80	795	550	970	500	415	12	366
100	TTGW100	795	550	970	500	415	12	414
125	TTGW125	970	670	1250	582	470	18	550
160	TTGW160	970	670	1250	582	470	18	632
200	TTGW200	970	670	1250	582	470	18	810
250	TTGW250	1200	760	1555	672	690	18	924
315	TTGW315	1200	760	1555	672	690	18	1094
400	TTGW400	1200	760	1555	672	690	18	1189

TTGX IP00

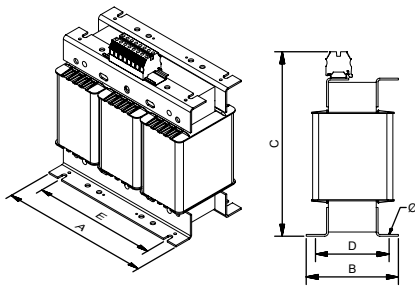

From 10 kVA to 12.5 kVA

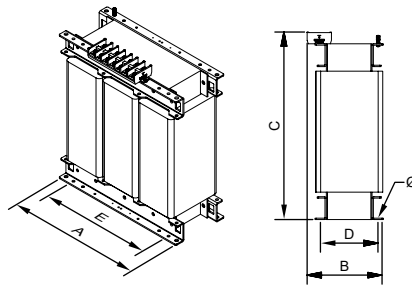

From 16 kVA to 200 kVA

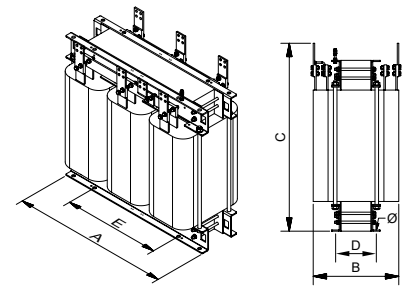

From 250 kVA

TTGW IP23

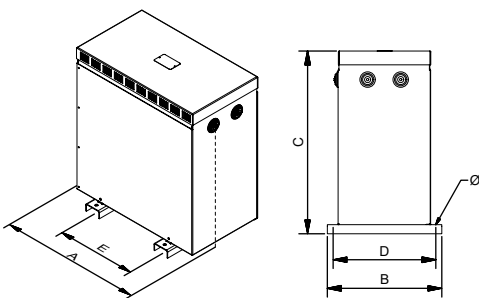

From 10 kVA to 40 kVA

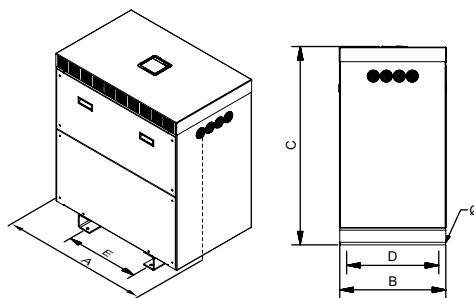

From 50 kVA



Sectioned



TTG SERIES

Ecological three-phase isolation · Input 400 V · Output 400 V + N

Measurements

Power kVA	Reference	External dimensions mm			Fastening elements mm			Weight kg
		A	B	C	D	E	∅	
TTGZ								
10	TTGZ10	694	413	764	370	350	11	130
12.5	TTGZ12.5	694	413	764	370	350	11	153
16	TTGZ16	694	413	764	370	350	11	192
20	TTGZ20	694	413	764	370	350	11	206
25	TTGZ25	694	413	764	370	350	11	238
31.5	TTGZ31.5	694	413	764	370	350	11	252
40	TTGZ40	694	413	764	370	350	11	299
50	TTGZ50	890	560	1148	520	426	13	343
63	TTGZ63	890	560	1148	520	426	13	386
80	TTGZ80	890	560	1148	520	426	13	434
100	TTGZ100	890	560	1148	520	426	13	627
125	TTGZ125	972	740	1480	660	470	17	663
160	TTGZ160	972	740	1480	660	470	17	913
200	TTGZ200	972	740	1480	660	470	17	1027
250	TTGZ250	1394	870	1762	810	690	17	1187
315	TTGZ315	1394	870	1762	810	690	17	1282
400	TTGZ400	1394	870	1762	810	690	17	1395

TTGZ IP54 / 65

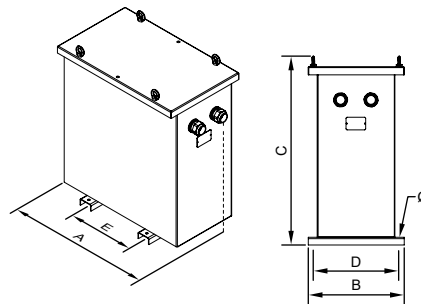



TTG SERIES

Ecological three-phase isolation · Input **400 V** · Output **400 V + N**

On-request manufacturing options (please see prices)

Power	From 10 kVA to 400 kVA
Voltage	From 1 V to 12 kV
Windings	Copper or aluminium
Frequency	From 50 Hz to 400 Hz
Connection unit	Yyn0, Dyn11, Dd0, Dy1, Dyn5, Yn1/5/11... (See Technical Appendix T.A.2)
IP rating	IP00, IP20, IP23, IP31, IP42, IP54, IP55 and IP65
IK rating	IK08 and IK10
Room temperature	Up to 60 °C
Locks	Screw, key
Test voltage	Up to 28 kV
Short circuit voltage	From 2% to 9%
Losses	Low losses, ecological
Operation	Intermittent, continuous
Cooling	Natural, forced ventilation
Electrostatic shield	Up to three shields
Class	I, II
Altitude	Up to 4000 m
Protections	In both primary and secondary (figure 1)
Temperature sensors	PT100 (figure 2), PTC (figure 3) or bimetallic
Temperature control	Temperature control station (4xPT100) (figure 4), PTC thermal relays (3xPTC / 6xPTC)
Network analyser	(Figure 5)
Anti condensation system	Higrostat
Heating system	Heating elements
External protection	Anti-flash varnish, metallic or stainless steel enclosure
Transportation and hoisting	Wheels (figure 6), lifting points
Paint	C3, C4, C5, different RAL
Feature plate	High generation polymer or stainless steel (figure 7)
Anti vibration system	Silentblock
Adjustment	-10%; -7.5%; -5%; -2.5%; +2.5%; +5%; +7.5%; +10% With bridges (figure 8) or selector (figure 9)
Certified	CE, DNV-GL, BV, UL (insulation) and POLYLUX laboratory
Climate class / environment / fire	Up to C2-E2-F1



Figure 1



Figure 2



Figure 3



Figure 4



Figure 5



Figure 6



Figure 7



Figure 8



Figure 9



TTG SERIES

Ecological three-phase isolation · Input 400 V · Output 400 V + N

Feature plate structure

Plastic label up to 31,5 kVA:

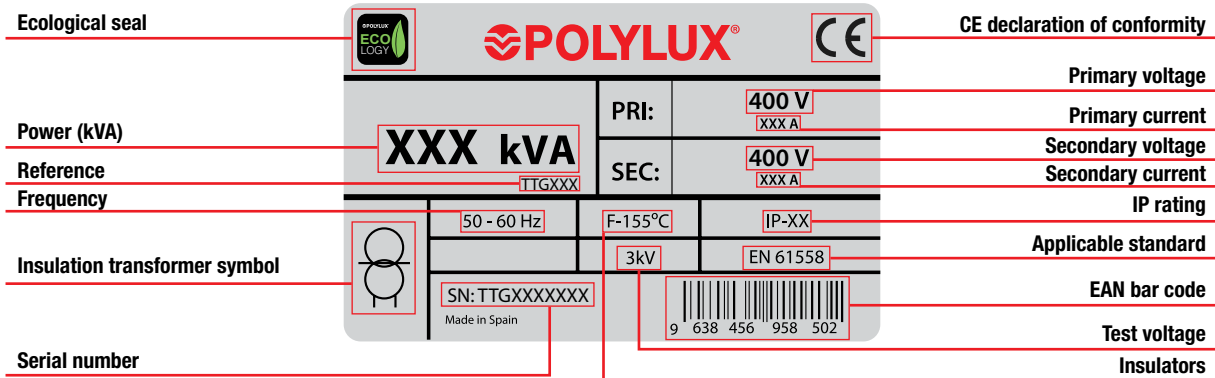

Stainless steel label from 40 kVA:

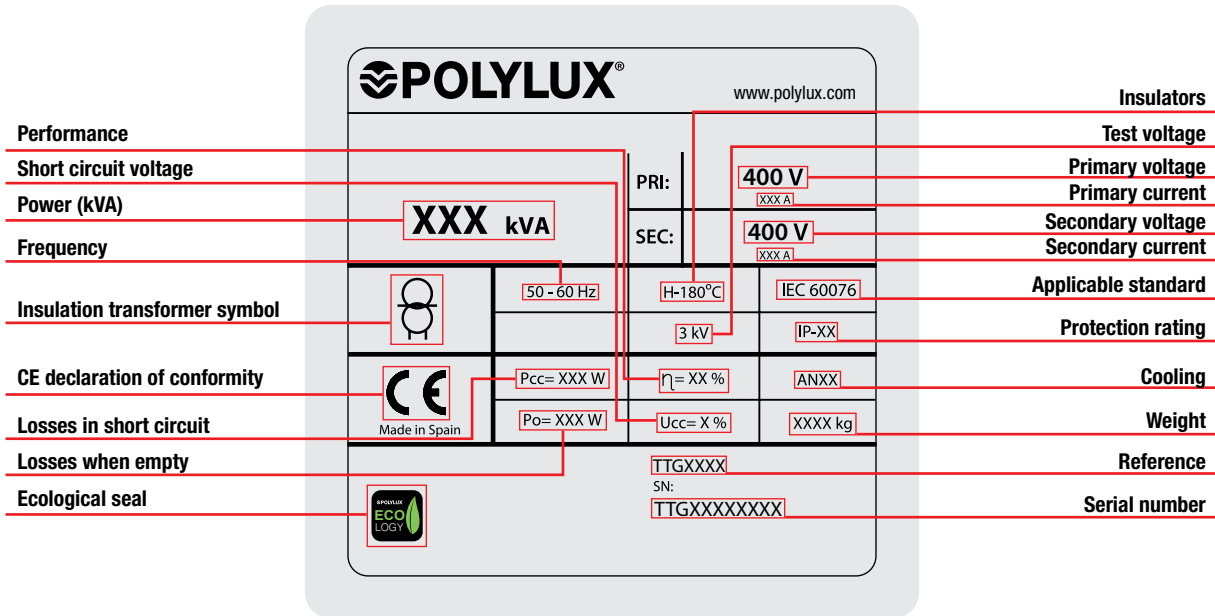



PAU SERIES

Reversible · For voltage changes **400 / 230 V**

Definition and applications

The PAU SERIES single-phase autotransformers have a robust, modern design and are perfect for working with continuous power to supply industrial, tertiary and residential installations and machinery. Due to its design, it has an IP20 rating that prevents direct electrical contact and protects windings perfectly.

This autotransformer can make voltage changes from 400 V to 230 V and from 230 V to 400 V or other voltages on request in single-phase installations.

Manufacturing characteristics

All the versions have the following features in common:

- Anti-flash dip varnishing. Ensures greater compactation, insulation and noise elimination.
- Connection terminals made of copper, welded and inserted in blocks to prevent hazards caused by expansion that may lead to poor connection.
- Option of installing on **DIN rail up to 630 VA**.
- Convertible from Class I to Class II (up to 6300 VA)
- LED indicator lamp.
- All the transformers are checked automatically one by one and the compliance test report is created in accordance with the corresponding standard.



Up to 6300 VA

- Technical polymer box.
- UL 94 V-0 flame retardant material.
- Protective terminal cover to prevent direct contact.
- Ventilation ducts at the top and along the perimeter.
- Feature label with all the connection and protection instructions.



From 8000 VA

- Epoxy painted metal box resistant to all types of damp and corrosive atmospheres.
- Protective terminal cover to prevent direct contact.
- Ventilation ducts along the box perimeter.
- Feature label with all the connection and protection instructions.



NEW head design

- Increased wiring insulation.
- Clearer features.
- Easier connection.
- More uniform, compact and robust design.

Technical features - standard model

Power	100 VA to 12500 VA
Insulators	Class B - 130 °C
Winding	Class HC - 200 °C
Room temperature	45 °C
Frequency	50-60 Hz
Noise	≤ 65 dB (PTU1P), ≤ 80 dB (PTU3P)
Protection rating	IP20
Cooling	ANAN
Includes	LED indicator lamp
Mounting	With screws (for all powers) Mounting on DIN 46277/3 rail (up to 630 VA)
Standards	IEC/EN/UNE-EN 61558, CE
Protection	Convertible from Class I to Class II (up to 6300 VA)
Operation	Continuous
Test voltage	3 kV (1 min., 50 Hz)

Electrical diagram

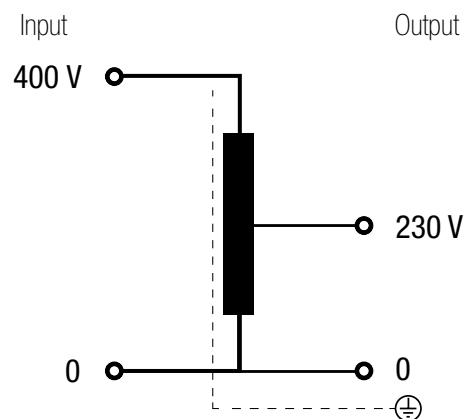



PAU SERIES

Reversible · For voltage changes **400 / 230 V**

Terminal types

Terminal blocks	External mm				Maximum tightening torque N·m	Primary Power VA		Secondary Power VA	
	A	B	C	Ø		From	To	From	To
	Terminal M3	8	11	9		M3	0.5	100	200
Terminal M4	10	13.5	12	M4	1.1	315	2500	315	630
Terminal M5	15	18.5	14	M5	2.5	3150	12500	1000	2500
Terminal M6	15.5	20.4	13	M6	4	-	-	3150	12500

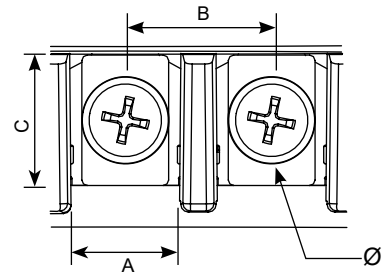

Theoretical data - standard model

Power VA	Reference	Input current	Output current	Maximum cross-section input conductor (mm²)		Maximum cross-section output conductor (mm²)		Input protections (A) (MCB -> D / Fuse -> aM)	Output protections (A) (MCB -> C / Fuse -> gG)
		400 V	230 V	Flexible	Rigid	Flexible	Rigid		
100	PAU100	0.25	0.43	0.5	0.5	0.5	1	0.5	0.4
200	PAU200	0.50	0.87	0.5	1	0.5	1	1	0.8
315	PAU315	0.79	1.37	0.5	1	0.5	1	2	1
400	PAU400	1.00	1.74	0.5	1	1	1.5	2	1.6
500	PAU500	1.25	2.17	0.5	1	1	1.5	3	2
630	PAU630	1.58	2.74	1	1.5	1	1.5	4	2.5
1000	PAU1000	2.50	4.35	1	1.5	1.5	2	6	4
2000	PAU2000	5.00	8.70	1.5	2	2	2.5	10	8
2500	PAU2500	6.25	10.87	1.5	2	2.5	4	16	10
3150	PAU3150	7.88	13.70	2	2.5	2.5	4	16	12
4000	PAU4000	10.00	17.39	2	2.5	4	-	20	12
5000	PAU5000	12.50	21.74	2.5	4	4	-	25	20
6300	PAU6300	15.75	27.39	4	-	6	-	40	25
8000	PAU8000	20.00	34.78	4	-	8	-	40	32
10000	PAU10000	25.00	43.48	4	-	10	-	50	40
12500	PAU12500	31.25	54.35	8	-	-	-	80	50

Measurements

Power kVA	Reference	External dimensions mm			Fastening elements mm			Weight kg
		A	B	C	D	E	Ø	
100	PAU100	84	101	98	88	55	5	1
200	PAU200	84	101	98	88	55	5	1.2
315	PAU315	106	123	118	110	74	5	2.3
400	PAU400	106	123	118	110	74	5	2.3
500	PAU500	106	123	118	110	74	5	2.7
630	PAU630	106	123	118	110	74	5	3.3
1000	PAU1000	118	138	131	121	88	6	4.9
2000	PAU2000	136	162	156	145	104	6	8.6
2500	PAU2500	136	162	156	145	104	6	10
3150	PAU3150	214	225	284	195	175	7	16.6
4000	PAU4000	214	225	284	195	175	7	20.8
5000	PAU5000	214	225	284	195	175	7	25.9
6300	PAU6300	214	225	284	195	175	7	28.7
8000	PAU8000	247	260	349	233	223	7	36.7
10000	PAU10000	247	260	349	233	223	7	43.5
12500	PAU12500	247	260	349	233	223	7	56.1

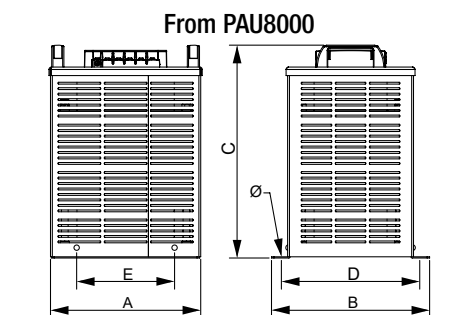
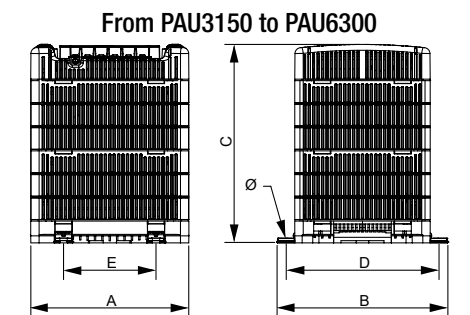
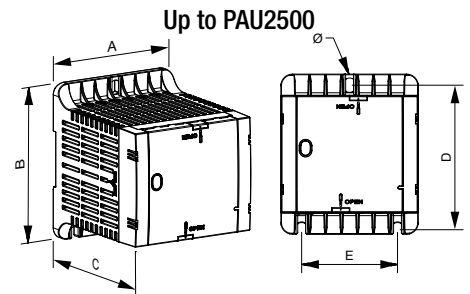



PAU SERIES

Reversible · For voltage changes **400 / 230 V**

On-request manufacturing options (please see prices)

Power	From 100 VA to 12500 VA
Protections	Primary fuse

Feature plate structure

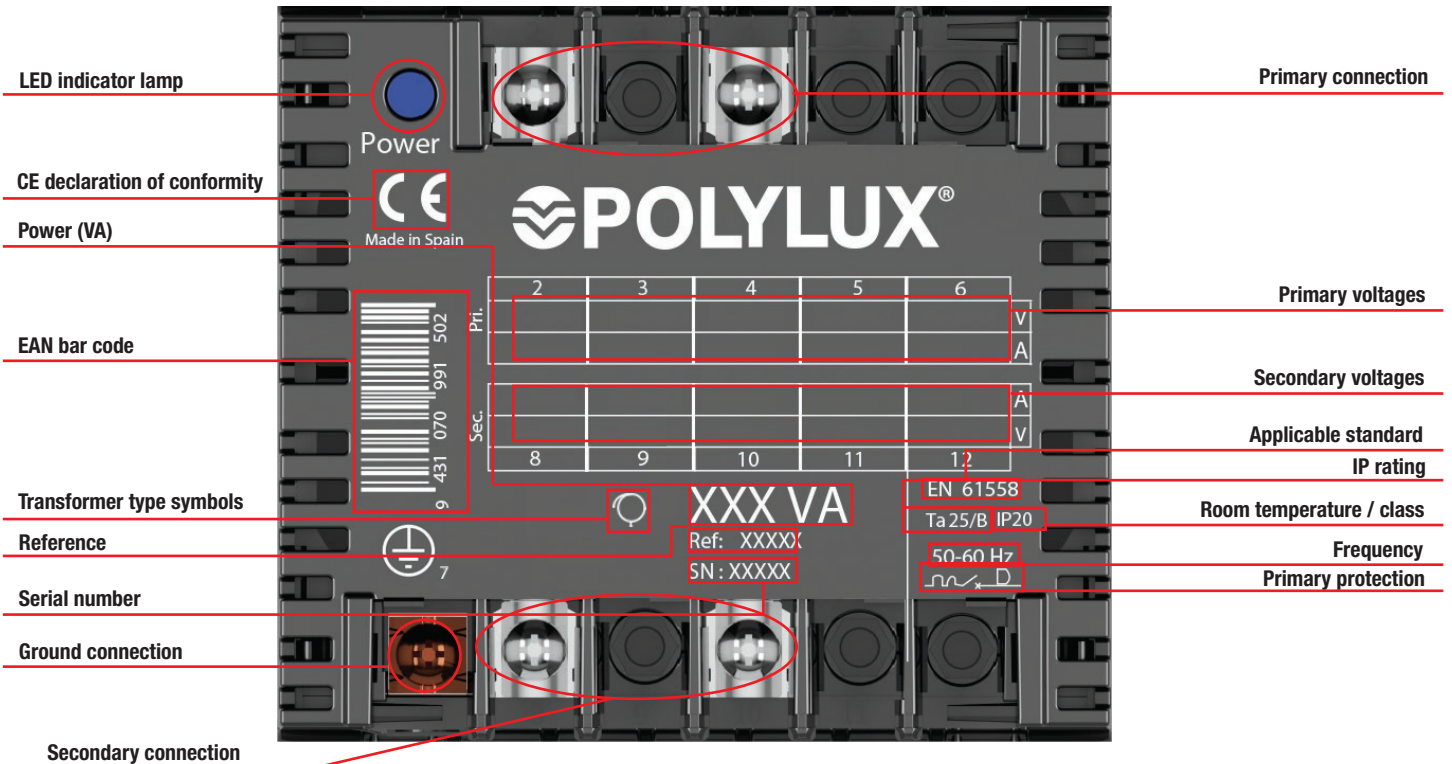



QAU SERIES

Encapsulated reversible • For voltage changes **400 / 230 V**



Up to 2500 VA.

- Technical polymer box.
- UL 94 V-0 flame retardant material.
- Encapsulated in flame retardant resin.
- Protective terminal cover to prevent direct contact.
- Ventilation ducts at the top.
- Feature label with all the connection and protection instructions.



From 3150 VA.

- Completely encapsulated in flame retardant resin.
- Protective terminal cover to prevent direct contact.
- Feature label with all the connection and protection instructions.



NEW head design

- Increased wiring insulation.
- Clearer features.
- Easier connection.
- More uniform, compact and robust design.

Definition and applications

The QAU single-phase autotransformer series have a robust and modern design and are perfect for continuous operation in supplying industrial, tertiary or residential installations and machinery. Due to its design, it has an IP20 rating that prevents direct electrical contact and protects windings perfectly. This autotransformer can make voltage changes from 400 V to 230 V and from 230 V to 400 V or other voltages on request in single-phase installations.

Manufacturing characteristics

- Protected against indirect contacts.
- Convertible from Class I to Class II.
- LED indicator lamp included.
- Optional protective fuse.
- Mounted on **DIN rail (up to 630 VA)** or with screws.
- Option of special fabrications if the standard specification are inadequate.
- Encapsulated in flame retardant resin.
- Protection against damp, saline and corrosive environments.
- Greater mechanical resistance to vibrations, power surges and transient harmonics.
- All the transformers are checked automatically one by one and the compliance test report is created in accordance with the corresponding standard.

Technical features - standard model

Power	100 VA to 6300 VA
Insulators	Class B - 130 °C
Winding	Class HC - 200 °C
Room temperature	45 °C
Frequency	50-60 Hz
Noise	≤ 65 dB (QTU1P), ≤ 80 dB (QTU3P)
Protection rating	IP20
Cooling	AN
Includes	LED indicator lamp
Mounting	With screws (for all powers) Mounting on DIN 46277/3 rail (up to 630 VA)
Standards	IEC/EN/UNE-EN 61558, CE
Protection	Convertible from Class I to Class II
Operation	Continuous
Test voltage	3 kV (1 min., 50 Hz)

Electrical diagram

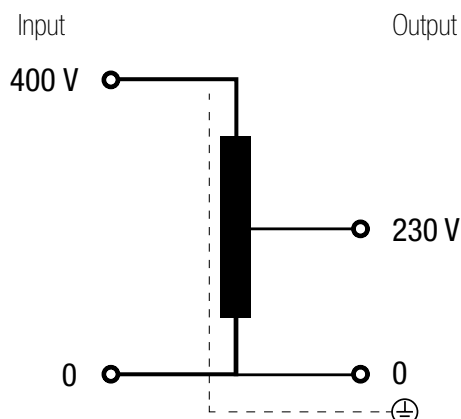



QAU SERIES

Encapsulated reversible · For voltage changes **400 / 230 V**

Terminal types

Terminal blocks	External mm				Maximum tightening torque N·m	Primary Power VA		Secondary Power VA	
	A	B	C	Ø		From	To	From	To
	Terminal M3	8	11	9		M3	0.5	100	200
Terminal M4	10	13.5	12	M4	1.1	315	2500	315	630
Terminal M5	15	18.5	14	M5	2.5	3150	6300	1000	2500
Terminal M6	15.5	20.4	13	M6	4	-	-	3150	6300

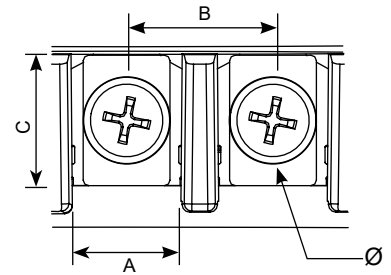

Theoretical data - standard model

Power VA	Reference	Input current	Output current	Maximum cross-section input conductor (mm ²)		Maximum cross-section output conductor (mm ²)		Input protections (A) (MCB -> D / Fuse -> aM)	Output protections (A) (MCB -> C / Fuse -> gG)
		400 V	230 V	Flexible	Rigid	Flexible	Rigid		
100	QAU100	0.25	0.43	0.5	0.5	0.5	1	0.5	0.4
200	QAU200	0.50	0.87	0.5	1	0.5	1	1	0.8
315	QAU315	0.79	1.37	0.5	1	0.5	1	2	1
400	QAU400	1.00	1.74	0.5	1	1	1.5	2	1.6
500	QAU500	1.25	2.17	0.5	1	1	1.5	3	2
630	QAU630	1.58	2.74	1	1.5	1	1.5	4	2.5
1000	QAU1000	2.50	4.35	1	1.5	1.5	2	6	4
2000	QAU2000	5.00	8.70	1.5	2	2	2.5	10	8
2500	QAU2500	6.25	10.87	1.5	2	2.5	4	16	10
3150	QAU3150	7.88	13.70	2	2.5	2.5	4	16	12
4000	QAU4000	10.00	17.39	2	2.5	4	-	20	12
5000	QAU5000	12.50	21.74	2.5	4	4	-	25	20
6300	QAU6300	15.75	27.39	4	-	6	-	40	25

Measurements

Power kVA	Reference	External dimensions mm			Fastening elements mm			Weight kg
		A	B	C	D	E	Ø	
100	QAU100	84	101	98	88	55	5	1.2
200	QAU200	84	101	98	88	55	5	1.4
315	QAU315	106	123	118	110	74	5	2.6
400	QAU400	106	123	118	110	74	5	2.6
500	QAU500	106	123	118	110	74	5	3
630	QAU630	106	123	118	110	74	5	3.7
1000	QAU1000	118	138	131	121	88	6	5.6
2000	QAU2000	136	162	156	145	104	6	9.9
2500	QAU2500	136	162	156	145	104	6	11.5
3150	QAU3150	233	241	244	219	175	7	25.6
4000	QAU4000	233	241	274	219	175	7	30
5000	QAU5000	233	241	314	219	175	7	37.6
6300	QAU6300	233	241	314	219	175	7	38.5

Up to QAU2500

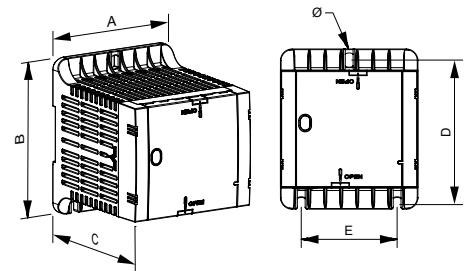

From QAU3150

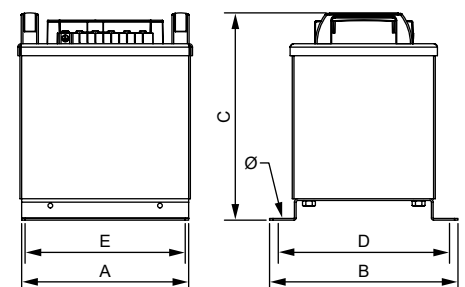



QAU SERIES

Encapsulated reversible · For voltage changes 400 / 230 V

On-request manufacturing options (please see prices)

Power	From 100 VA to 6500 VA
Protections	Primary fuse

Feature plate structure

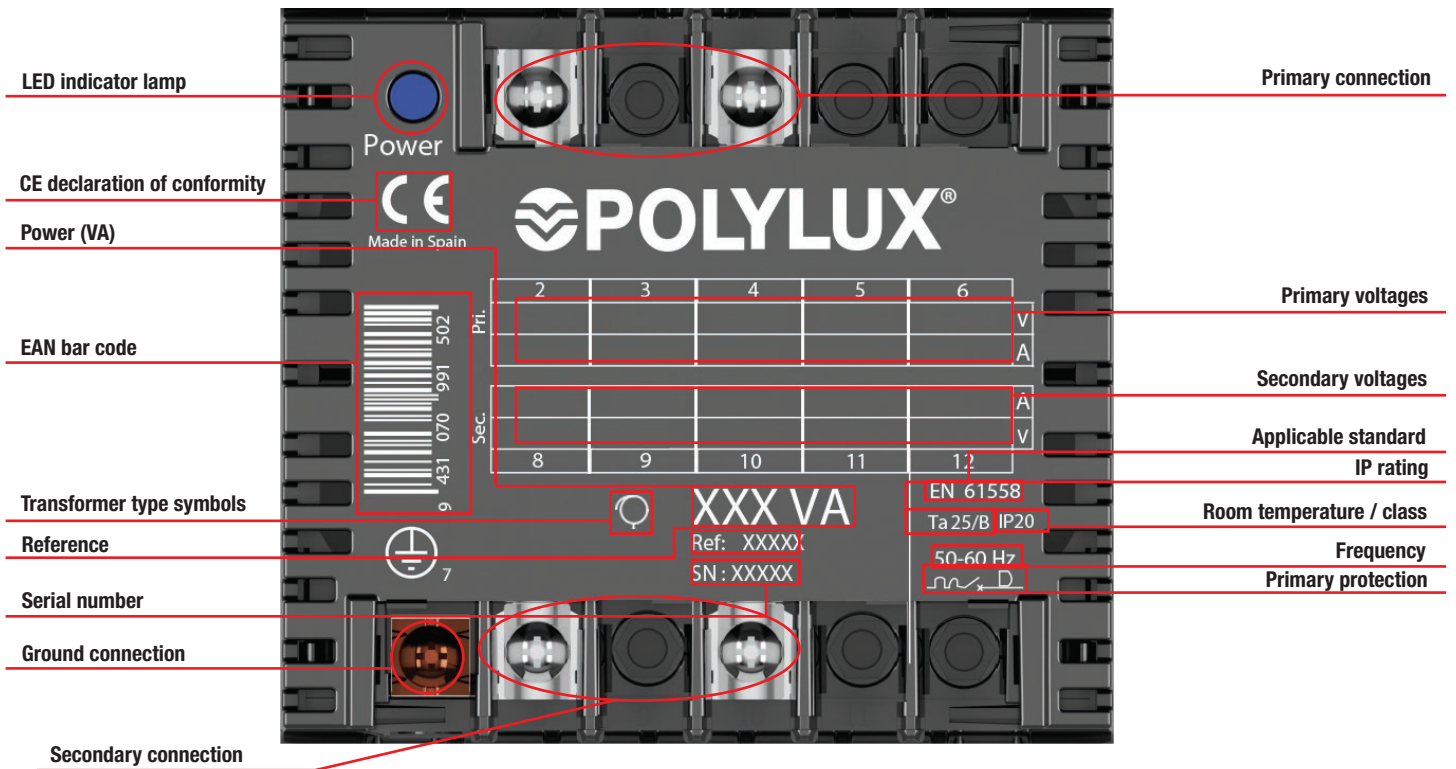



AUR SERIES

Reversible · For voltage changes **220 / 125 V**



Up to 1000 VA

- Made with epoxy resin-painted protective covers.
- Male to male cable included.
- Metal handle included.



From 1500 VA

- Made with epoxy resin-painted protective covers.
- Connection with screw connection strip

Definition and applications

The AUR series are dry, reversible single-phase autotransformers designed to solve problems that arise in connecting industrial and household appliances with different voltages. Their IP20 rating prevents direct electrical contact and their winding is completely protected.

Manufacturing characteristics

- Protected against indirect contacts.
- Core protected against corrosion.

Technical features - standard model

Power	100 VA to 4000 VA
Insulators	Class B - 130 °C
Winding	Class H - 180 °C
Room temperature	45 °C
Frequency	50-60 Hz
Protection rating	IP20
Cooling	ANAN
Accessories	Male to male cable up to 1000 VA Metal handle from 300 to 1000 VA
Standards	EN 61558-2-13
Protection	Class I

Electrical diagram

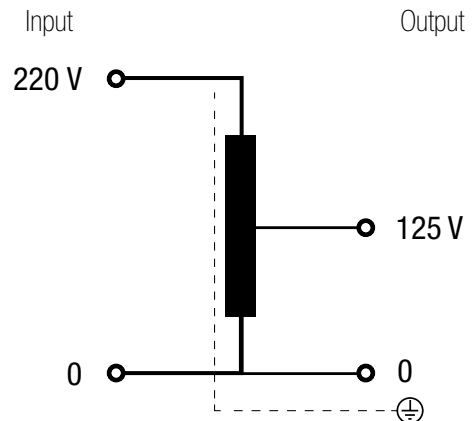



AUR SERIES

Reversible · For voltage changes **220 / 125 V**

Terminal types

Terminal blocks	External mm		Maximum tightening torque N·m	Primary		Secondary	
	A	Ø		Power VA		Power VA	
				From	To	From	To
Female	-	-	-	100	1000	100	1000
Power strip	14	6	0.5	1500	4000	1500	4000

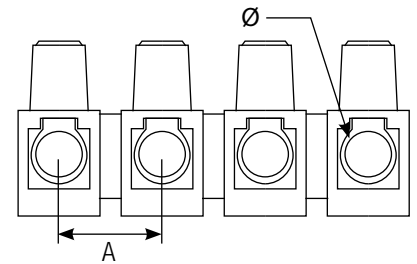

Theoretical data - standard model

Power VA	Reference	Current input / output A		Maximum cross-section conductor input / output (mm²)		Maximum cross-section conductor input / output (mm²)		Input protections (A) (MCB -> D / Fuse -> aM)		Output protections (A) (MCB -> C / Fuse -> gG)	
		220 V	125 V	Flexible	Rigid	Flexible	Rigid	220 V	125 V	220 V	125 V
100	AUR100	0.45	0.80	-	-	-	-	1	2	0.4	0.8
300	AUR300	1.36	2.40	-	-	-	-	3	6	1	2
500	AUR500	2.27	4.00	-	-	-	-	6	10	2	4
1000	AUR1000	4.55	8.00	-	-	-	-	10	16	4	8
1500	AUR1500	6.82	12.00	1.5	2	2.4	4	16	25	6	12
2500	AUR2500	11.36	20.00	2.5	4	4	-	25	40	10	20
4000	AUR4000	18.18	32.00	4	-	8	-	40	80	16	32

Measurements

Power kVA	Reference	External dimensions mm			Weight kg
		A	B	C	
100	AUR100	75	102	65	1
300	AUR300	84	115	75	2.1
500	AUR500	96	122	83	2.7
1000	AUR1000	108	143	92	4.5
1500	AUR1500	126	150	108	6.7
2500	AUR2500	126	175	108	9
4000	AUR4000	150	190	128	14

Up to AUR1000

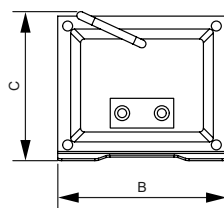
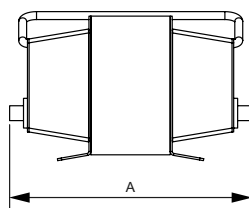

From AUR1500

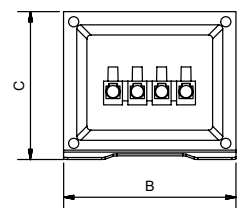
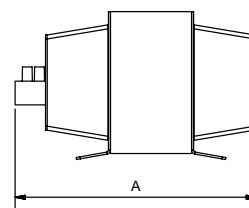

Feature plate structure

Transformer type symbol

Model
AUR XXX

CE declaration of conformity

Made in Spain

Tax ID

30 min / 60 min INTERMITTENT USE

Power (VA)

XXX VA

Primary voltage

125/220V

Frequency

50/60 Hz



AUT SERIES

Reversible · For voltage changes **400 V / 230 V**

Definition and applications

The AUT series are reversible three-phase autotransformers designed to operate continuously at maximum output.

Their main application is for changing voltages from 400 V to 230 V and from 230 V to 400 V or other voltages on request in three-phase installations.



AUTX

- IP00 protection rating.
- Power from 1 kVA to 1000 kVA.
- Total impregnated in anti-flash varnish.
- Hoisting elements included.

Manufacturing characteristics

- All the autotransformers are dipped in anti-flash varnish and then compacted in the furnace. This process increases the insulation grade, reduces noise and provides anti-moisture, waterproofed protection.
- The high power autotransformers are made with format cores and low loss properties, thus contributing to increasing their performance.
- All the autotransformers are checked automatically one by one and the compliance report is created based on the respective standard.



AUTW

- IP23 rating (IK08).
- Power from 1 kVA to 1000 kVA.
- Metal box painted with RAL7035 polyester resin.
- High resistance to corrosion.
- Cable outlet with cable gland.
- Hoisting elements included.
- Detachable top and front cover.

Technical features - standard model

Power	1 kVA to 1000 kVA
Standard voltage	Reversible 400 V / 230 V
Standard frequency	50-60 Hz
Connection unit	YNO
Windings	Class HC-200 °C
Insulators	Class F - 155 °C ≤ 80 kVA Class H - 180 °C ≥ 100 kVA <small>*More information in Technical Appendix (T.A.1)</small>
Class	I
Altitude	1000 m
Enclosure colour	RAL 7035
IP rating	IP00 (AUTX) IP23 (AUTW) IP54 / 65 (AUTZ)
IK rating	IK08 (AUTW) IK10 (AUTZ)
Paint class (ISO 12944)	C3 (AUTW) C4 (AUTZ)
Room temperature	45 °C
Standards	IEC/EN 61558, CE up to 31.5 kVA IEC/EN 60076, CE from 40 kVA
Test voltage	3 kV (1 min., 50 Hz)
Inrush	< 12 In
Ucc	≤ 4 %
K factor	4
Operation	Continuous
Cooling	AN (AUTX) - ANAN (AUTW / AUTZ)



AUTZ

- IP54 rating / 65 (IK10).
- Power from 1 kVA to 1000 kVA.
- Metal box painted with RAL7035 polyester resin.
- High resistance to corrosion.
- Stuffing box cover for cable input depending on installation needs.
- Hoisting elements included.
- Detachable top cover.
- With silentblock.

Electrical diagram

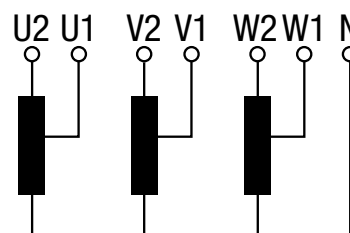

Connection

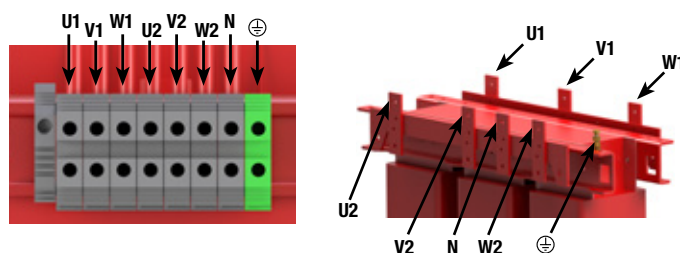



AUT SERIES

Reversible • For voltage changes **400 V / 230 V**

Terminal types

Terminals	Maximum cross-section conductor mm ²	Maximum tightening torque		AUTX-AUTW-AUTZ				
				Power kVA				
				Input		Output		
		N-m	Lb-In	From	To	From	To	
Power strip 1	Terminal 4	6	0.5	4.4	1	2	1	2
	Terminal 10	16	1.2	10.6	3.15	5	3.15	5
	Terminal 16	25	1.2	10.6	8	12.5	8	12.5
	Terminal 35	50	2.5	22.1	16	31.5	16	31.5
	Terminal 50	70	6	53.1	40	50	40	50
Power strip 2	Terminal 100	35	6.7	60	63	63	-	-
	Terminal 200	95	9	80	80	80	63	80
	Terminal 300	150	9	80	100	125	100	125
Connection plate	Plate 30 X 1	150	-	-	160	160	-	-
	Plate 40 X 1	150	-	-	200	250	160	160
	Plate 50 X 1	150	-	-	315	500	200	250
	Plate 60 X 2	150	-	-	630	800	315	500
	Plate 80 X 4	150	-	-	1000	1000	630	800
	Plate 100 X 4	150	-	-	-	-	1000	1000

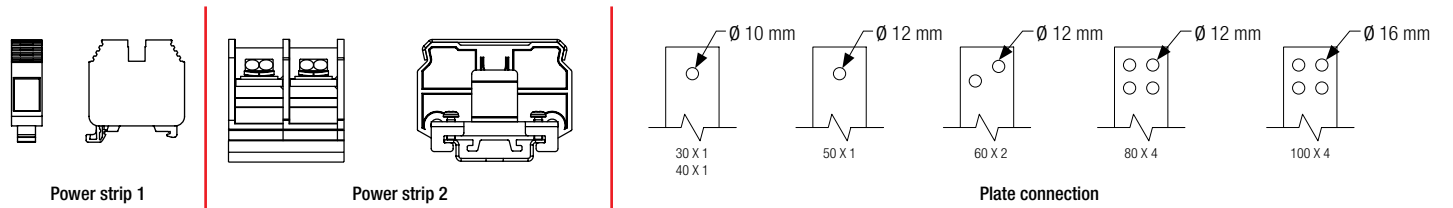

Theoretical data - standard model

Power kVA	Reference	Insulation class	Current A		Protections A		Protections A		Noise dB
			400 V	230 V	Input (400 V)	Output (230 V)	Input (230 V)	Output (400 V)	
AUTX									
1	AUTX1	F	1.4	2.5	3 (D/Am)	2.5 (C/Gg)	6 (D/Am)	1 (C/Gg)	≤45
2	AUTX2	F	2.9	5.0	10 (D/Am)	5 (C/Gg)	10 (D/Am)	2.5 (C/Gg)	≤45
3.15	AUTX3.15	F	4.5	7.9	10 (D/Am)	7 (C/Gg)	16 (D/Am)	4 (C/Gg)	≤45
5	AUTX5	F	7.2	12.6	16 (D/Am)	12 (C/Gg)	32 (D/Am)	7 (C/Gg)	≤45
8	AUTX8	F	11.5	20.1	25 (D/Am)	20 (C/Gg)	50 (D/Am)	10 (C/Gg)	≤45
10	AUTX10	F	14.4	25.1	32 (D/Am)	25 (C/Gg)	63 (D/Am)	12 (C/Gg)	≤45
12.5	AUTX12.5	F	18.0	31.4	40 (D/Am)	30 (C/Gg)	80 (D/Am)	12 (C/Gg)	≤45
16	AUTX16	F	23.1	40.2	50 (D/Am)	40 (C/Gg)	100 (D/Am)	20 (C/Gg)	≤45
20	AUTX20	F	28.9	50.2	63 (D/Am)	50 (C/Gg)	125 (D/Am)	25 (C/Gg)	≤45
25	AUTX25	F	36.1	62.8	40 (D/Am)	60 (C/Gg)	160 (D/Am)	30 (C/Gg)	≤45
31.5	AUTX31.5	F	45.5	79.1	100 (D/Am)	60 (C/Gg)	160 (D/Am)	40 (C/Gg)	≤45
40	AUTX40	F	57.7	100.4	125 (D/Am)	100 (C/Gg)	300 (D/Am)	50 (C/Gg)	≤55
50	AUTX50	F	72.2	125.5	160 (D/Am)	100 (C/Gg)	300 (D/Am)	60 (C/Gg)	≤55
63	AUTX63	F	90.9	158.1	200 (D/Am)	150 (C/Gg)	400 (D/Am)	80 (C/Gg)	≤55
80	AUTX80	F	115.5	200.8	300 (D/Am)	200 (C/Gg)	500 (D/Am)	100 (C/Gg)	≤55
100	AUTX100	H	144.3	251.0	300 (D/Am)	250 (C/Gg)	600 (D/Am)	100 (C/Gg)	≤55
125	AUTX125	H	180.4	313.8	400 (D/Am)	300 (C/Gg)	800 (D/Am)	160 (C/Gg)	≤55
160	AUTX160	H	230.9	401.6	500 (D/Am)	400 (C/Gg)	1000 (D/Am)	200 (C/Gg)	≤55
200	AUTX200	H	288.7	502.0	600 (D/Am)	500 (C/Gg)	1200 (D/Am)	250 (C/Gg)	≤55
250	AUTX250	H	360.8	627.6	800 (D/Am)	600 (C/Gg)	1600 (D/Am)	300 (C/Gg)	≤65
315	AUTX315	H	454.7	790.7	1000 (D/Am)	600 (C/Gg)	2000 (D/Am)	400 (C/Gg)	≤65
400	AUTX400	H	577.4	1004.1	1200 (D/Am)	1000 (C/Gg)	2500 (D/Am)	500 (C/Gg)	≤65
500	AUTX500	H	721.7	1255.1	1600 (D/Am)	1000 (C/Gg)	2500 (D/Am)	600 (C/Gg)	≤65
630	AUTX630	H	909.3	1581.4	2000 (D/Am)	1500 (C/Gg)	-	800 (C/Gg)	≤65
800	AUTX800	H	1154.7	2008.2	2500 (D/Am)	-	-	1000 (C/Gg)	≤65
1000	AUTX1000	H	1443.4	2510.2	2500 (D/Am)	-	-	1000 (C/Gg)	≤65



AUT SERIES

Reversible • For voltage changes **400 V / 230 V**

Theoretical data - standard model

Power kVA	Ref.	Insulation class	Current A		Protections A		Protections A		Noise dB	Cable gland (AUTW) Stuffing boxes (AUTZ)	
			400 V	230 V	Input (400 V)	Output (230 V)	Input (230 V)	Output (400 V)		ø max. (mm)	Quantity
AUTW											
1	AUTW1	F	1.4	2.5	3 (D/Am)	2.5 (C/Gg)	6 (D/Am)	1 (C/Gg)	≤45	14	2
2	AUTW2	F	2.9	5.0	10 (D/Am)	5 (C/Gg)	10 (D/Am)	2.5 (C/Gg)	≤45	14	2
3.15	AUTW3.15	F	4.5	7.9	10 (D/Am)	7 (C/Gg)	16 (D/Am)	4 (C/Gg)	≤45	14	2
5	AUTW5	F	7.2	12.6	16 (D/Am)	12 (C/Gg)	32 (D/Am)	7 (C/Gg)	≤45	14	2
8	AUTW8	F	11.5	20.1	25 (D/Am)	20 (C/Gg)	50 (D/Am)	10 (C/Gg)	≤45	18	2
10	AUTW10	F	14.4	25.1	32 (D/Am)	25 (C/Gg)	63 (D/Am)	12 (C/Gg)	≤45	18	2
12.5	AUTW12.5	F	18.0	31.4	40 (D/Am)	30 (C/Gg)	80 (D/Am)	12 (C/Gg)	≤45	18	2
16	AUTW16	F	23.1	40.2	50 (D/Am)	40 (C/Gg)	100 (D/Am)	20 (C/Gg)	≤45	18	2
20	AUTW20	F	28.9	50.2	63 (D/Am)	50 (C/Gg)	125 (D/Am)	25 (C/Gg)	≤45	25	4
25	AUTW25	F	36.1	62.8	40 (D/Am)	60 (C/Gg)	160 (D/Am)	30 (C/Gg)	≤45	25	4
31.5	AUTW31.5	F	45.5	79.1	100 (D/Am)	60 (C/Gg)	160 (D/Am)	40 (C/Gg)	≤45	25	4
40	AUTW40	F	57.7	100.4	125 (D/Am)	100 (C/Gg)	300 (D/Am)	50 (C/Gg)	≤55	32	4
50	AUTW50	F	72.2	125.5	160 (D/Am)	100 (C/Gg)	300 (D/Am)	60 (C/Gg)	≤55	32	4
63	AUTW63	F	90.9	158.1	200 (D/Am)	150 (C/Gg)	400 (D/Am)	80 (C/Gg)	≤55	32	4
80	AUTW80	F	115.5	200.8	300 (D/Am)	200 (C/Gg)	500 (D/Am)	100 (C/Gg)	≤55	32	4
100	AUTW100	H	144.3	251.0	300 (D/Am)	250 (C/Gg)	600 (D/Am)	100 (C/Gg)	≤55	32	8
125	AUTW125	H	180.4	313.8	400 (D/Am)	300 (C/Gg)	800 (D/Am)	160 (C/Gg)	≤55	32	8
160	AUTW160	H	230.9	401.6	500 (D/Am)	400 (C/Gg)	1000 (D/Am)	200 (C/Gg)	≤55	32	8
200	AUTW200	H	288.7	502.0	600 (D/Am)	500 (C/Gg)	1200 (D/Am)	250 (C/Gg)	≤55	32	8
250	AUTW250	H	360.8	627.6	800 (D/Am)	600 (C/Gg)	1600 (D/Am)	300 (C/Gg)	≤65	32	8
315	AUTW315	H	454.7	790.7	1000 (D/Am)	600 (C/Gg)	2000 (D/Am)	400 (C/Gg)	≤65	44	8
400	AUTW400	H	577.4	1004.1	1200 (D/Am)	1000 (C/Gg)	2500 (D/Am)	500 (C/Gg)	≤65	44	8
500	AUTW500	H	721.7	1255.1	1600 (D/Am)	1000 (C/Gg)	2500 (D/Am)	600 (C/Gg)	≤65	44	8
630	AUTW630	H	909.3	1581.4	2000 (D/Am)	1500 (C/Gg)	-	800 (C/Gg)	≤65	44	8
800	AUTW800	H	1154.7	2008.2	2500 (D/Am)	-	-	1000 (C/Gg)	≤65	44	8
1000	AUTW1000	H	1443.4	2510.2	2500 (D/Am)	-	-	1000 (C/Gg)	≤65	44	8
AUTZ											
1	AUTZ1	F	1.4	2.5	3 (D/Am)	2.5 (C/Gg)	6 (D/Am)	1 (C/Gg)	≤45	10 - 14	2
2	AUTZ2	F	2.9	5.0	10 (D/Am)	5 (C/Gg)	10 (D/Am)	2.5 (C/Gg)	≤45	10 - 14	2
3.15	AUTZ3.15	F	4.5	7.9	10 (D/Am)	7 (C/Gg)	16 (D/Am)	4 (C/Gg)	≤45	10 - 14	2
5	AUTZ5	F	7.2	12.6	16 (D/Am)	12 (C/Gg)	32 (D/Am)	7 (C/Gg)	≤45	18 - 25	2
8	AUTZ8	F	11.5	20.1	25 (D/Am)	20 (C/Gg)	50 (D/Am)	10 (C/Gg)	≤45	18 - 25	2
10	AUTZ10	F	14.4	25.1	32 (D/Am)	25 (C/Gg)	63 (D/Am)	12 (C/Gg)	≤45	18 - 25	2
12.5	AUTZ12.5	F	18.0	31.4	40 (D/Am)	30 (C/Gg)	80 (D/Am)	12 (C/Gg)	≤45	18 - 25	2
16	AUTZ16	F	23.1	40.2	50 (D/Am)	40 (C/Gg)	100 (D/Am)	20 (C/Gg)	≤45	18 - 25	2
20	AUTZ20	F	28.9	50.2	63 (D/Am)	50 (C/Gg)	125 (D/Am)	25 (C/Gg)	≤45	18 - 25	2
25	AUTZ25	F	36.1	62.8	40 (D/Am)	60 (C/Gg)	160 (D/Am)	30 (C/Gg)	≤45	18 - 25	2
31.5	AUTZ31.5	F	45.5	79.1	100 (D/Am)	60 (C/Gg)	160 (D/Am)	40 (C/Gg)	≤45	22 - 32	2
40	AUTZ40	F	57.7	100.4	125 (D/Am)	100 (C/Gg)	300 (D/Am)	50 (C/Gg)	≤50	22 - 32	2
50	AUTZ50	F	72.2	125.5	160 (D/Am)	100 (C/Gg)	300 (D/Am)	60 (C/Gg)	≤50	22 - 32	2
63	AUTZ63	F	90.9	158.1	200 (D/Am)	150 (C/Gg)	400 (D/Am)	80 (C/Gg)	≤50	22 - 32	2
80	AUTZ80	F	115.5	200.8	300 (D/Am)	200 (C/Gg)	500 (D/Am)	100 (C/Gg)	≤50	22 - 32	2
100	AUTZ100	H	144.3	251.0	300 (D/Am)	250 (C/Gg)	600 (D/Am)	100 (C/Gg)	≤50	22 - 32	2
125	AUTZ125	H	180.4	313.8	400 (D/Am)	300 (C/Gg)	800 (D/Am)	160 (C/Gg)	≤50	22 - 32	2
160	AUTZ160	H	230.9	401.6	500 (D/Am)	400 (C/Gg)	1000 (D/Am)	200 (C/Gg)	≤50	22 - 32	2
200	AUTZ200	H	288.7	502.0	600 (D/Am)	500 (C/Gg)	1200 (D/Am)	250 (C/Gg)	≤55	22 - 32	2
250	AUTZ250	H	360.8	627.6	800 (D/Am)	600 (C/Gg)	1600 (D/Am)	300 (C/Gg)	≤55	22 - 32	2
315	AUTZ315	H	454.7	790.7	1000 (D/Am)	600 (C/Gg)	2000 (D/Am)	400 (C/Gg)	≤60	34 - 44	2
400	AUTZ400	H	577.4	1004.1	1200 (D/Am)	1000 (C/Gg)	2500 (D/Am)	500 (C/Gg)	≤60	34 - 44	2
500	AUTZ500	H	721.7	1255.1	1600 (D/Am)	1000 (C/Gg)	2500 (D/Am)	600 (C/Gg)	≤65	34 - 44	2
630	AUTZ630	H	909.3	1581.4	2000 (D/Am)	1500 (C/Gg)	-	800 (C/Gg)	≤65	34 - 44	2
800	AUTZ800	H	1154.7	2008.2	2500 (D/Am)	-	-	1000 (C/Gg)	≤65	34 - 44	2
1000	AUTZ1000	H	1443.4	2510.2	2500 (D/Am)	-	-	1000 (C/Gg)	≤65	34 - 44	2





AUT SERIES

Reversible • For voltage changes **400 V / 230 V**

Measurements

Power kVA	Reference	External dimensions mm			Fastening elements mm			Weight kg
		A	B	C	D	E	Ø	
AUTX								
1	AUTX1	150	79	178	51	125	6	3.4
2	AUTX2	180	84	203	66	150	6	6.6
3.15	AUTX3.15	180	129	203	110	150	6	12
5	AUTX5	240	128	253	104	200	9	17
8	AUTX8	300	124	303	115	250	9	23
10	AUTX10	300	144	303	135	250	9	31
12.5	AUTX12.5	300	154	303	145	250	9	36
16	AUTX16	300	174	303	165	250	9	45
20	AUTX20	360	144	353	122	300	11	47
25	AUTX25	360	164	353	142	300	11	60
31.5	AUTX31.5	360	184	353	162	300	11	72
40	AUTX40	420	190	419	156	350	11	90
50	AUTX50	420	210	419	176	350	11	105
63	AUTX63	480	290	480	184	400	11	140
80	AUTX80	480	310	480	204	400	11	162
100	AUTX100	670	280	615	170	426	13	199
125	AUTX125	670	300	615	190	426	13	225
160	AUTX160	670	320	690	210	426	13	288
200	AUTX200	670	340	690	230	426	13	339
250	AUTX250	670	360	690	250	426	13	385
315	AUTX315	785	550	880	460	472	17	462
400	AUTX400	785	550	880	460	472	17	600
500	AUTX500	1016	550	1080	460	690	17	855
630	AUTX630	1070	550	1220	460	690	17	918
800	AUTX800	1070	550	1220	460	690	17	1250
1000	AUTX1000	1300	550	1350	460	800	17	1605

Power kVA	Reference	External dimensions mm			Fastening elements mm			Weight kg
		A	B	C	D	E	Ø	
AUTW								
1	AUTW1	194	175	220	165	100	6	5.2
2	AUTW2	240	190	250	180	150	6	10.3
3.15	AUTW3.15	240	190	250	180	150	6	15.7
5	AUTW5	315	230	315	205	200	6	21.3
8	AUTW8	385	260	384	245	250	6	28
10	AUTW10	385	260	384	245	250	6	36
12.5	AUTW12.5	385	260	384	245	250	6	42
16	AUTW16	385	260	384	245	250	6	51
20	AUTW20	458	340	500	300	300	12	53
25	AUTW25	458	340	500	300	300	12	66
31.5	AUTW31.5	458	340	500	300	300	12	78
40	AUTW40	528	418	644	375	345	12	103
50	AUTW50	528	418	644	375	345	12	118
63	AUTW63	597	415	710	375	345	12	152
80	AUTW80	597	415	710	375	345	12	174
100	AUTW100	795	550	970	500	415	12	245
125	AUTW125	795	550	970	500	415	12	271
160	AUTW160	795	550	970	500	415	12	334
200	AUTW200	795	550	970	500	415	12	385
250	AUTW250	795	550	970	500	415	12	431
315	AUTW315	970	670	1250	582	470	18	514
400	AUTW400	970	670	1250	582	470	18	652
500	AUTW500	1200	760	1555	672	690	18	920
630	AUTW630	1200	760	1555	672	690	18	1011
800	AUTW800	1200	760	1555	672	690	18	1406
1000	AUTW1000	1530	1000	1880	900	800	20	1855

AUTX IP00

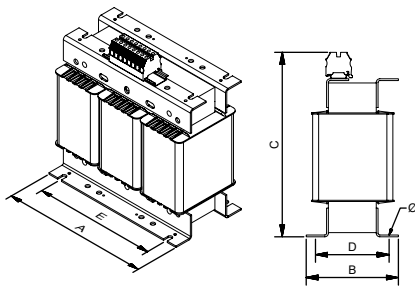

Up to 50 kVA

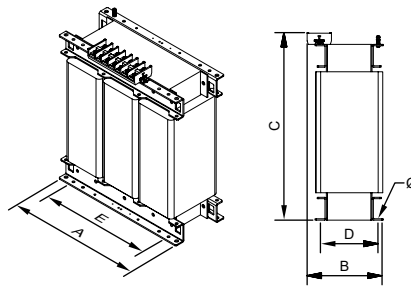

From 63 kVA to 125 kVA

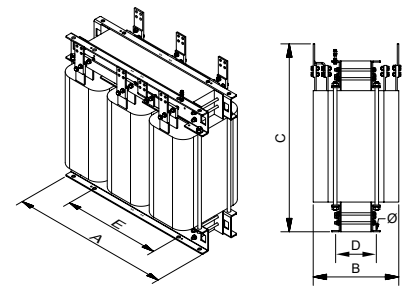

From 160 kVA

AUTW IP23

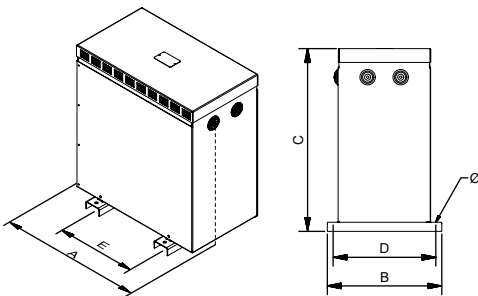

Up to 80 kVA

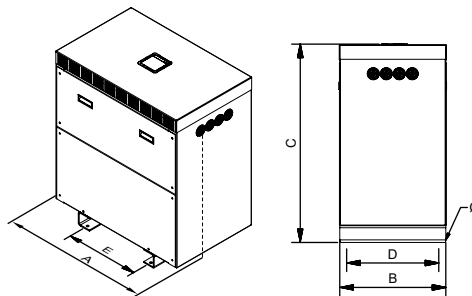

From 100 kVA



Sectioned



AUT SERIES

Reversible • For voltage changes **400 V / 230 V**

Measurements

Power kVA	Reference	External dimensions mm			Fastening elements mm			Weight kg
		A	B	C	D	E	∅	
AUTZ								
1	AUTZ1	330	284	463	230	200	11	19.6
2	AUTZ2	330	284	463	230	200	11	25
3.15	AUTZ3.15	330	284	463	230	200	11	27
5	AUTZ5	510	362	689	320	250	11	39
8	AUTZ8	510	362	689	320	250	11	52
10	AUTZ10	510	362	689	320	250	11	57
12.5	AUTZ12.5	510	362	689	320	250	11	66
16	AUTZ16	510	362	689	320	250	11	76
20	AUTZ20	510	362	689	320	250	11	83
25	AUTZ25	510	362	689	320	250	11	99
31.5	AUTZ31.5	694	413	764	370	350	11	122
40	AUTZ40	694	413	764	370	350	11	133
50	AUTZ50	694	413	764	370	350	11	180
63	AUTZ63	694	413	764	370	350	11	202
80	AUTZ80	694	413	764	370	350	11	262
100	AUTZ100	890	560	1148	520	426	13	299
125	AUTZ125	890	560	1148	520	426	13	325
160	AUTZ160	890	560	1148	520	426	13	388
200	AUTZ200	890	560	1148	520	426	13	434
250	AUTZ250	890	560	1148	520	426	13	604
315	AUTZ315	972	740	1480	660	470	17	710
400	AUTZ400	972	740	1480	660	470	17	1023
500	AUTZ500	1394	870	1762	810	690	17	1104
630	AUTZ630	1394	870	1762	810	690	17	1256
800	AUTZ800	1394	870	1762	810	690	17	1588
1000	AUTZ1000	1640	1226	1770	1110	800	17	2055

AUTZ IP54 / 65

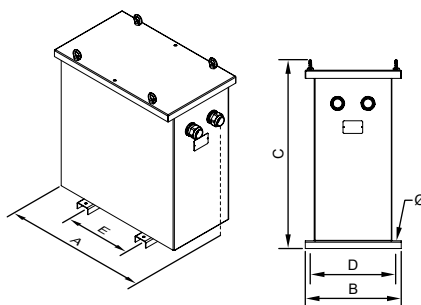



AUT SERIES

Reversible · For voltage changes **400 V / 230 V**

On-request manufacturing options (please see prices)

Power	From 1 kVA to 1000 kVA
Voltage	From 1 V to 12 kV
Windings	Copper or aluminium
Frequency	From 50 Hz to 400 Hz
IP rating	IP00, IP20, IP23, IP31, IP42, IP54, IP55 and IP65
IK rating	IK08 and IK10
Room temperature	Up to 60 °C
Locks	Screw, key
Short circuit voltage	From 2% to 9%
Operation	Intermittent, continuous
Cooling	Natural, forced ventilation
Class	I, II
Altitude	Up to 4000 m
Protections	In both primary and secondary (figure 1)
Temperature sensors	PT100 (figure 2), PTC (figure 3) or bimetallic
Temperature control	Temperature control station (4xPT100) (figure 4), PTC thermal relays (3xPTC / 6xPTC)
Network analyser	(Figure 5)
Anti condensation system	Higrostat
Heating system	Heating elements
External protection	Anti-flash varnish, metallic or stainless steel enclosure
Transportation and hoisting	Wheels (figure 6), lifting points
Paint	C3, C4, C5, different RAL
Feature plate	High generation polymer or stainless steel (figure 7)
Anti vibration system	Silentblock
Adjustment	-10%; -7.5%; -5%; -2.5%; +2.5%; +5%; +7.5%; +10% With bridges (figure 8) or selector (figure 9)
Certified	CE, DNV-GL, BV, UL (insulation) and POLYLUX laboratory
Climate class / environment / fire	Up to C2-E2-F1



Figure 1



Figure 2



Figure 3



Figure 4



Figure 5



Figure 6



Figure 7



Figure 8



Figure 9



AUT SERIES

Reversible • For voltage changes **400 V / 230 V**

Feature plate structure

Plastic label up to 80 kVA:

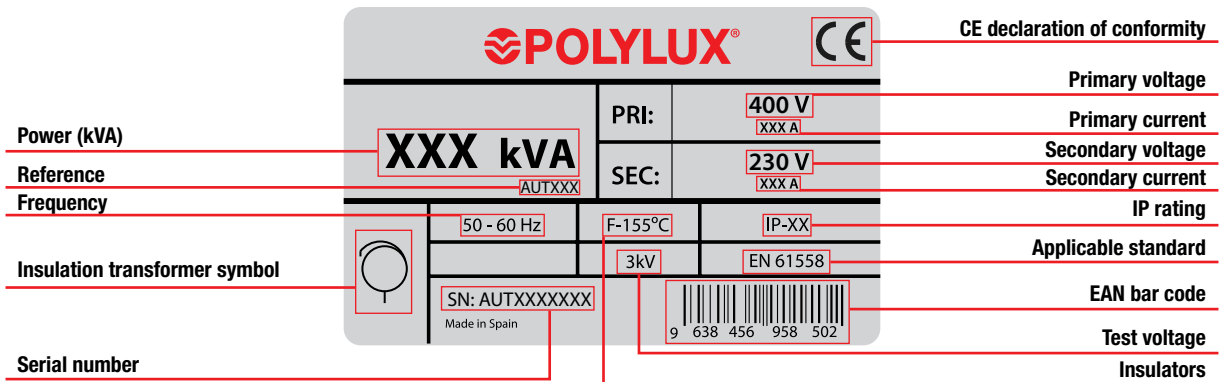

Stainless steel label from 100 kVA:

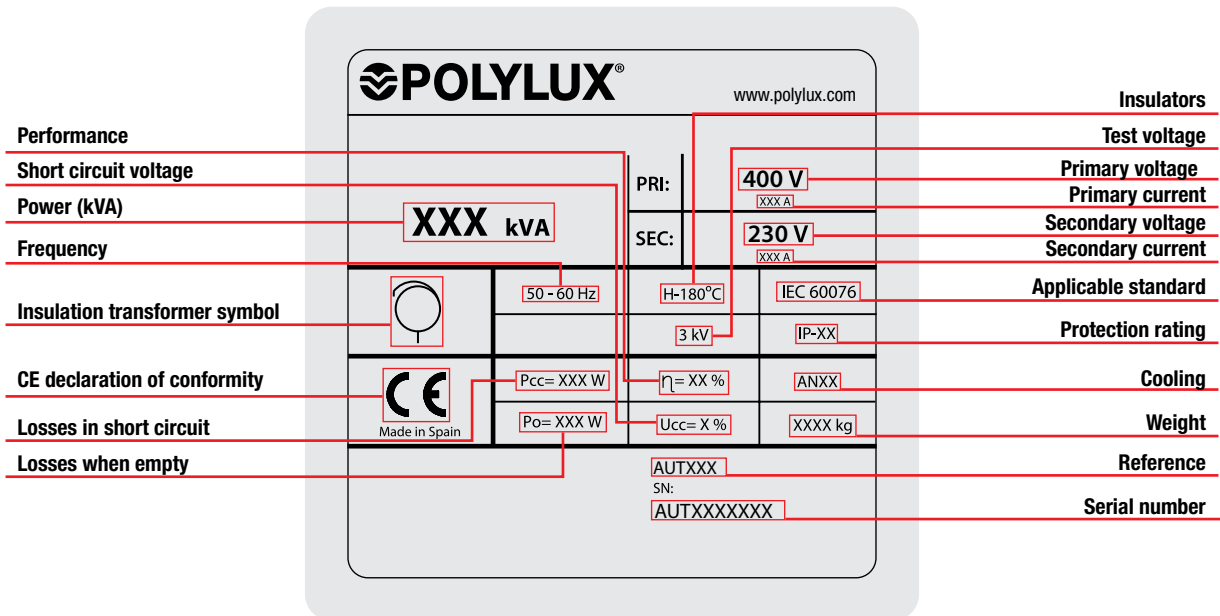



AUTN SERIES

For creating artificial neutral in three-phase lines · Input **400 V** · Output **Neutral** · **Zig-zag connection**

Definition and applications

The AUTN series are three-phase autotransformers designed to operate continuously and at maximum output.

Their main use, based on the zig-zag connection, is to withstand network voltage imbalances and provide a more stable neutral.



AUTNX

- IP00 protection rating.
- Power from 1 kVA to 400 kVA.
- Total impregnated in anti-flash varnish.
- Hoisting elements included.

Manufacturing characteristics

- All the autotransformers are dipped in anti-flash varnish and then compacted in the furnace. This process increases the insulation grade, reduces noise and provides anti-moisture, waterproofed protection.
- The high power autotransformers are made with format cores and low loss properties, thus contributing to increasing their performance.
- All the transformers are checked automatically one by one and the compliance test report is created in accordance with the corresponding standard.



AUTNW

- IP23 rating (IK08).
- Power from 1 kVA to 400 kVA.
- Metal box painted with RAL7035 polyester resin.
- High resistance to corrosion.
- Cable outlet with cable gland.
- Hoisting elements included.
- Detachable top and front cover.

Technical features - standard model

Power	1 kVA to 400 kVA
Standard voltage	Input 400 V // Output Neutral
Standard frequency	50-60 Hz
Connection unit	ZNO
Windings	Class HC-200 °C
Insulators	Class F - 155 °C ≤ 50 kVA 40 kVA AUTNZ Class H - 180 °C ≥ 63 kVA (50 kVA AUTNZ) <small>*More information in Technical Appendix (T.A.1)</small>
Class	I
Altitude	1000 m
Enclosure colour	RAL 7035
IP rating	IP00 (AUTNX) IP23 (AUTNW) IP54 / 65 (AUTNZ)
IK rating	IK08 (AUTNW) IK10 (AUTNZ)
Paint class (ISO 12944)	C3 (AUTNW) C4 (AUTNZ)
Room temperature	45 °C
Standards	IEC/EN 61558, CE up to 31.5 kVA IEC/EN 60076, CE from 40 kVA
Test voltage	3 kV (1 min., 50 Hz)
Inrush	< 12 In
K factor	4
Operation	Continuous
Cooling	AN (AUTNX) - ANAN (AUTNW / AUTNZ)



AUTNZ

- IP54 rating / 65 (IK10).
- Power from 1 kVA to 400 kVA.
- Metal box painted with RAL7035 polyester resin.
- High resistance to corrosion.
- Stuffing box cover for cable input depending on installation needs.
- Hoisting elements included.
- Detachable top cover.
- With silentblock.

Electrical diagram

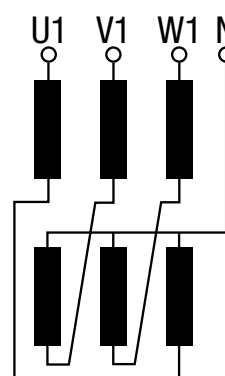

Connection

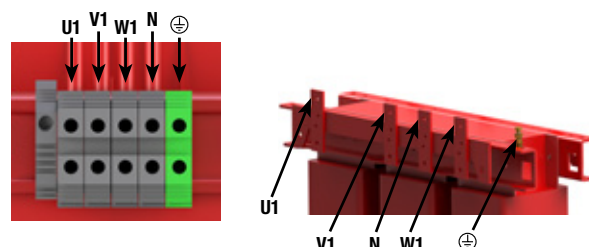



AUTN SERIES

For creating artificial neutral in three-phase lines · Input **400 V** · Output **Neutral** · **Zig-zag connection**

Terminal types

Terminals	Maximum cross-section conductor mm ²	Maximum tightening torque		AUTNX-AUTNW		AUTNZ		
				Power kVA		Power kVA		
		N-m	Lb-In	From	To	From	To	
Power strip 1	Terminal 4	6	0.5	4.4	1	3.15	1	3.15
	Terminal 16	25	1.2	10.6	5	10	5	10
	Terminal 35	50	2.5	22.1	12.5	20	12.5	16
Power strip 2	Terminal 60	25	4.5	40	25	40	20	40
	Terminal 100	35	6.7	60	50	63	50	63
	Terminal 200	95	9	80	80	125	80	125
Connection plate	Terminal 300	150	9	80	160	200	160	200
	Plate 40 X 1	150	-	-	250	315	250	315
	Plate 50 X 1	150	-	-	400	400	400	400

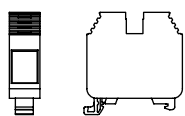

Power strip 1

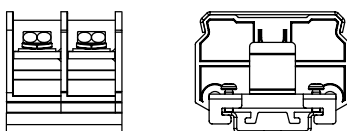

Power strip 2

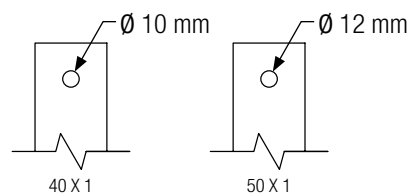

Plate connection

Theoretical data - standard model

Power kVA	Reference	Insulation class	Current A		Protections A		Noise dB
			Input	Output	Input	Output	
AUTNX							
1	AUTNX1	F	1.4	1.4	3 (D/Am)	1 (C/Gg)	≤45
2	AUTNX2	F	2.9	2.9	10 (D/Am)	2.5 (C/Gg)	≤45
3.15	AUTNX3.15	F	4.5	4.5	10 (D/Am)	4 (C/Gg)	≤45
5	AUTNX5	F	7.2	7.2	16 (D/Am)	7 (C/Gg)	≤45
8	AUTNX8	F	11.5	11.5	25 (D/Am)	10 (C/Gg)	≤45
10	AUTNX10	F	14.4	14.4	32 (D/Am)	12 (C/Gg)	≤45
12.5	AUTNX12.5	F	18.0	18.0	40 (D/Am)	12 (C/Gg)	≤45
16	AUTNX16	F	23.1	23.1	50 (D/Am)	20 (C/Gg)	≤45
20	AUTNX20	F	28.9	28.9	63 (D/Am)	25 (C/Gg)	≤45
25	AUTNX25	F	36.1	36.1	40 (D/Am)	30 (C/Gg)	≤45
31.5	AUTNX31.5	F	45.5	45.5	100 (D/Am)	40 (C/Gg)	≤45
40	AUTNX40	F	57.7	57.7	125 (D/Am)	50 (C/Gg)	≤55
50	AUTNX50	F	72.2	72.2	160 (D/Am)	60 (C/Gg)	≤55
63	AUTNX63	H	90.9	90.9	200 (D/Am)	80 (C/Gg)	≤55
80	AUTNX80	H	115.5	115.5	300 (D/Am)	100 (C/Gg)	≤55
100	AUTNX100	H	144.3	144.3	300 (D/Am)	100 (C/Gg)	≤55
125	AUTNX125	H	180.4	180.4	400 (D/Am)	160 (C/Gg)	≤55
160	AUTNX160	H	230.9	230.9	500 (D/Am)	200 (C/Gg)	≤55
200	AUTNX200	H	288.7	288.7	600 (D/Am)	250 (C/Gg)	≤55
250	AUTNX250	H	360.8	360.8	800 (D/Am)	300 (C/Gg)	≤65
315	AUTNX315	H	454.7	454.7	1000 (D/Am)	400 (C/Gg)	≤65
400	AUTNX400	H	577.4	577.4	1200 (D/Am)	500 (C/Gg)	≤65





AUTN SERIES

For creating artificial neutral in three-phase lines · Input **400 V** · Output **Neutral** · **Zig-zag** connection

Theoretical data - standard model

Power kVA	Reference	Insulation class	Current A		Protections A		Noise dB	Cable gland (AUTNW) Stuffing boxes (AUTNZ)	
			Input	Output	Input	Output		ø max. (mm)	Quantity
AUTNW									
1	AUTNW1	F	1.4	1.4	3 (D/Am)	1 (C/Gg)	≤45	14	2
2	AUTNW2	F	2.9	2.9	10 (D/Am)	2.5 (C/Gg)	≤45	14	2
3.15	AUTNW3.15	F	4.5	4.5	10 (D/Am)	4 (C/Gg)	≤45	14	2
5	AUTNW5	F	7.2	7.2	16 (D/Am)	7 (C/Gg)	≤45	18	2
8	AUTNW8	F	11.5	11.5	25 (D/Am)	10 (C/Gg)	≤45	18	2
10	AUTNW10	F	14.4	14.4	32 (D/Am)	12 (C/Gg)	≤45	25	4
12.5	AUTNW12.5	F	18.0	18.0	40 (D/Am)	12 (C/Gg)	≤45	25	4
16	AUTNW16	F	23.1	23.1	50 (D/Am)	20 (C/Gg)	≤45	32	4
20	AUTNW20	F	28.9	28.9	63 (D/Am)	25 (C/Gg)	≤45	32	4
25	AUTNW25	F	36.1	36.1	40 (D/Am)	30 (C/Gg)	≤45	32	4
31.5	AUTNW31.5	F	45.5	45.5	100 (D/Am)	40 (C/Gg)	≤45	32	4
40	AUTNW40	F	57.7	57.7	125 (D/Am)	50 (C/Gg)	≤55	32	4
50	AUTNW50	F	72.2	72.2	160 (D/Am)	60 (C/Gg)	≤55	32	4
63	AUTNW63	H	90.9	90.9	200 (D/Am)	80 (C/Gg)	≤55	32	4
80	AUTNW80	H	115.5	115.5	300 (D/Am)	100 (C/Gg)	≤55	32	8
100	AUTNW100	H	144.3	144.3	300 (D/Am)	100 (C/Gg)	≤55	32	8
125	AUTNW125	H	180.4	180.4	400 (D/Am)	160 (C/Gg)	≤55	32	8
160	AUTNW160	H	230.9	230.9	500 (D/Am)	200 (C/Gg)	≤55	32	8
200	AUTNW200	H	288.7	288.7	600 (D/Am)	250 (C/Gg)	≤55	32	8
250	AUTNW250	H	360.8	360.8	800 (D/Am)	300 (C/Gg)	≤65	44	8
315	AUTNW315	H	454.7	454.7	1000 (D/Am)	400 (C/Gg)	≤65	44	8
400	AUTNW400	H	577.4	577.4	1200 (D/Am)	500 (C/Gg)	≤65	44	8
AUTNZ									
1	AUTNZ1	F	1.4	1.4	3 (D/Am)	1 (C/Gg)	≤45	10 - 14	2
2	AUTNZ2	F	2.9	2.9	10 (D/Am)	2.5 (C/Gg)	≤45	10 - 14	2
3.15	AUTNZ3.15	F	4.5	4.5	10 (D/Am)	4 (C/Gg)	≤45	18 - 25	2
5	AUTNZ5	F	7.2	7.2	16 (D/Am)	7 (C/Gg)	≤45	18 - 25	2
8	AUTNZ8	F	11.5	11.5	25 (D/Am)	10 (C/Gg)	≤45	18 - 25	2
10	AUTNZ10	F	14.4	14.4	32 (D/Am)	12 (C/Gg)	≤45	18 - 25	2
12.5	AUTNZ12.5	F	18.0	18.0	40 (D/Am)	12 (C/Gg)	≤45	22 - 32	2
16	AUTNZ16	F	23.1	23.1	50 (D/Am)	20 (C/Gg)	≤45	22 - 32	2
20	AUTNZ20	F	28.9	28.9	63 (D/Am)	25 (C/Gg)	≤45	22 - 32	2
25	AUTNZ25	F	36.1	36.1	40 (D/Am)	30 (C/Gg)	≤45	22 - 32	2
31.5	AUTNZ31.5	F	45.5	45.5	100 (D/Am)	40 (C/Gg)	≤45	22 - 32	2
40	AUTNZ40	F	57.7	57.7	125 (D/Am)	50 (C/Gg)	≤55	22 - 32	2
50	AUTNZ50	H	72.2	72.2	160 (D/Am)	60 (C/Gg)	≤55	22 - 32	2
63	AUTNZ63	H	90.9	90.9	200 (D/Am)	80 (C/Gg)	≤55	22 - 32	2
80	AUTNZ80	H	115.5	115.5	300 (D/Am)	100 (C/Gg)	≤55	22 - 32	2
100	AUTNZ100	H	144.3	144.3	300 (D/Am)	100 (C/Gg)	≤55	22 - 32	2
125	AUTNZ125	H	180.4	180.4	400 (D/Am)	160 (C/Gg)	≤55	22 - 32	2
160	AUTNZ160	H	230.9	230.9	500 (D/Am)	200 (C/Gg)	≤55	22 - 32	2
200	AUTNZ200	H	288.7	288.7	600 (D/Am)	250 (C/Gg)	≤55	22 - 32	2
250	AUTNZ250	H	360.8	360.8	800 (D/Am)	300 (C/Gg)	≤65	34 - 44	2
315	AUTNZ315	H	454.7	454.7	1000 (D/Am)	400 (C/Gg)	≤65	34 - 44	2
400	AUTNZ400	H	577.4	577.4	1200 (D/Am)	500 (C/Gg)	≤65	34 - 44	2



AUTN SERIES

For creating artificial neutral in three-phase lines · Input 400 V · Output Neutral · Zig-zag connection

Measurements

Power kVA	Reference	External dimensions mm			Fastening elements mm			Weight kg
		A	B	C	D	E	∅	
AUTNX								
1	AUTNX1	180	84	203	66	150	6	5
2	AUTNX2	240	108	253	84	200	9	11
3.15	AUTNX3.15	240	128	253	104	200	9	17
5	AUTNX5	300	134	303	125	250	9	26
8	AUTNX8	300	164	303	155	250	9	39
10	AUTNX10	360	144	353	114	300	11	46
12.5	AUTNX12.5	360	164	353	134	300	11	56
16	AUTNX16	420	170	419	136	350	11	70
20	AUTNX20	420	190	419	156	350	11	84
25	AUTNX25	480	250	480	144	400	11	92
31.5	AUTNX31.5	480	260	480	154	400	11	104
40	AUTNX40	480	270	480	164	400	11	115
50	AUTNX50	480	290	480	184	400	11	137
63	AUTNX63	480	310	480	204	400	11	160
80	AUTNX80	670	280	615	170	426	13	199
100	AUTNX100	670	300	615	190	426	13	225
125	AUTNX125	670	320	690	210	599	13	288
160	AUTNX160	670	340	690	230	599	13	339
200	AUTNX200	670	380	690	270	599	13	406
250	AUTNX250	785	550	880	460	472	17	529
315	AUTNX315	1016	550	1080	460	690	17	596
400	AUTNX400	1016	550	1080	460	690	17	676

Power kVA	Reference	External dimensions mm			Fastening elements mm			Weight kg
		A	B	C	D	E	∅	
AUTNW								
1	AUTNW1	240	190	250	180	150	6	8.7
2	AUTNW2	315	230	315	205	200	6	15.3
3.15	AUTNW3.15	315	230	315	205	200	6	21.3
5	AUTNW5	385	260	384	245	250	6	30.8
8	AUTNW8	385	260	384	245	250	6	43.8
10	AUTNW10	458	340	500	300	300	12	52
12.5	AUTNW12.5	458	340	500	300	300	12	62
16	AUTNW16	528	418	644	375	345	12	82
20	AUTNW20	528	418	644	375	345	12	96
25	AUTNW25	597	415	710	375	345	12	104
31.5	AUTNW31.5	597	415	710	375	345	12	116
40	AUTNW40	597	415	710	375	345	12	127
50	AUTNW50	597	415	710	375	345	12	149
63	AUTNW63	597	415	710	375	345	12	172
80	AUTNW80	795	550	970	500	415	12	245
100	AUTNW100	795	550	970	500	415	12	271
125	AUTNW125	795	550	970	500	415	12	334
160	AUTNW160	795	550	970	500	415	12	385
200	AUTNW200	795	550	970	500	415	12	415
250	AUTNW250	970	670	1250	582	470	18	581
315	AUTNW315	970	670	1250	582	470	18	661
400	AUTNW400	1200	760	1555	672	690	18	741

AUTNX IP00

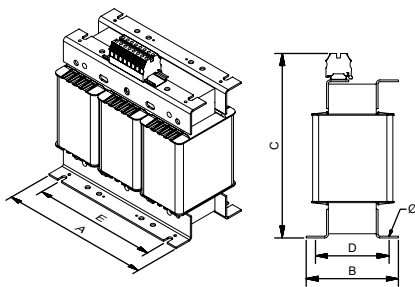

Up to 63 kVA

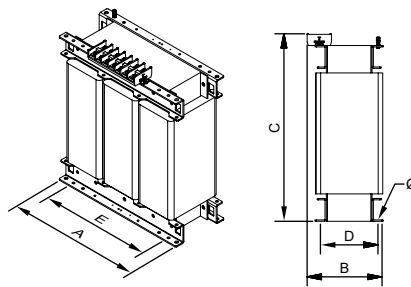

From 80 kVA to 160 kVA

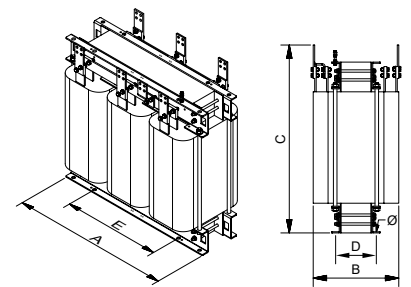

From 200 kVA

AUTNW IP23

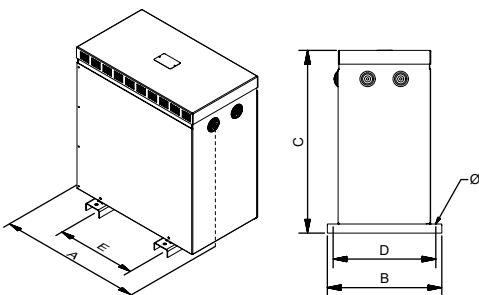

Up to 63 kVA

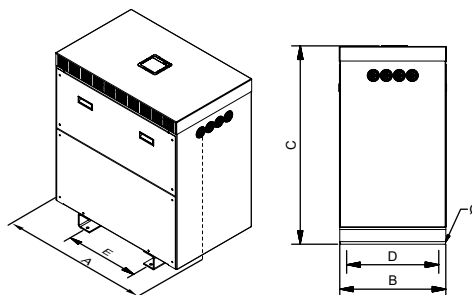

From 80 kVA



Sectioned



AUTN SERIES

For creating artificial neutral in three-phase lines · Input **400 V** · Output **Neutral** · **Zig-zag** connection

Measurements

Power kVA	Reference	External dimensions mm			Fastening elements mm			Weight kg
		A	B	C	D	E	∅	
AUTNZ								
1	AUTNZ1	330	284	463	230	200	11	24
2	AUTNZ2	330	284	463	230	200	11	30
3.15	AUTNZ3.15	510	362	689	320	250	11	47
5	AUTNZ5	510	362	689	320	250	11	60
8	AUTNZ8	510	362	689	320	250	11	67
10	AUTNZ10	510	362	689	320	250	11	77
12.5	AUTNZ12.5	694	413	764	370	350	11	110
16	AUTNZ16	694	413	764	370	350	11	124
20	AUTNZ20	694	413	764	370	350	11	132
25	AUTNZ25	694	413	764	370	350	11	144
31.5	AUTNZ31.5	694	413	764	370	350	11	155
40	AUTNZ40	694	413	764	370	350	11	177
50	AUTNZ50	694	413	764	370	350	11	189
63	AUTNZ63	694	413	764	370	350	11	260
80	AUTNZ80	890	560	1148	520	426	13	286
100	AUTNZ100	890	560	1148	520	426	13	349
125	AUTNZ125	890	560	1148	520	426	13	400
160	AUTNZ160	890	560	1148	520	426	13	430
200	AUTNZ200	890	560	1148	520	426	13	658
250	AUTNZ250	972	740	1480	660	470	17	764
315	AUTNZ315	972	740	1480	660	470	17	844
400	AUTNZ400	1394	870	1762	810	690	17	994

AUTNZ IP54 / 65

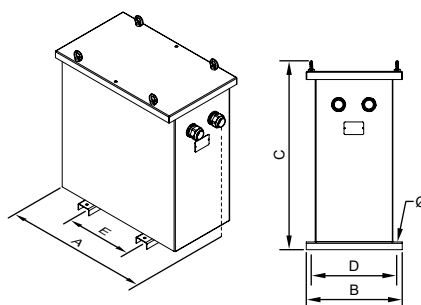



AUTN SERIES

For creating artificial neutral in three-phase lines · Input 400 V · Output Neutral · Zig-zag connection

On-request manufacturing options (please see prices)

Power	From 1 kVA to 400 kVA
Windings	Copper or aluminium
Frequency	From 50 Hz to 400 Hz
IP rating	IP00, IP20, IP23, IP31, IP42, IP54, IP55 and IP65
IK rating	IK08 and IK10
Room temperature	Up to 60 °C
Locks	Screw, key
Short circuit voltage	From 2% to 9%
Operation	Intermittent, continuous
Cooling	Natural, forced ventilation
Electrostatic shield	Up to three shields
Class	I, II
Altitude	Up to 4000 m
Protections	In both primary and secondary (figure 1)
Temperature sensors	PT100 (figure 2), PTC (figure 3) or bimetallic
Temperature control	Temperature control station (4xPT100) (figure 4), PTC thermal relays (3xPTC / 6xPTC)
Network analyser	(Figure 5)
Anti condensation system	Higrostat
Heating system	Heating elements
External protection	Anti-flash varnish, metallic or stainless steel enclosure
Transportation and hoisting	Wheels (figure 6), lifting points
Paint	C3, C4, C5, different RAL
Feature plate	High generation polymer or stainless steel (figure 7)
Anti vibration system	Silentblock
Adjustment	-10%; -7.5%; -5%; -2.5%; +2.5%; +5%; +7.5%; +10% With bridges (figure 8) or selector (figure 9)
Certified	CE, DNV-GL, BV, UL (insulation) and POLYLUX laboratory
Climate class / environment / fire	Up to C2-E2-F1



Figure 1



Figure 2



Figure 3



Figure 4



Figure 5



Figure 6



Figure 7



Figure 8



Figure 9





AUTN SERIES

For creating artificial neutral in three-phase lines · Input 400 V · Output Neutral · Zig-zag connection

Feature plate structure

Plastic label up to 63 kVA:

POLYLUX®		CE		CE declaration of conformity
Power (kVA)	XXX kVA	PRI:	400 V <small>XXX A</small>	Primary voltage
Reference	AUTNXXXX	SEC:	N	Primary current Neutral
Frequency	50 - 60 Hz	F-155°C	IP-XX	IP rating
Insulation transformer symbol		ZNO	3kV	Applicable standard
Connection unit	SN: AUTNXXXXXX <small>Made in Spain</small>	EN 61558		EAN bar code
Serial number			9 638 456 958 502	Test voltage Insulators

Stainless steel label from 100 kVA:

POLYLUX®		www.polylux.com		Insulators
Performance	XXX kVA	PRI:	400 V <small>XXX A</small>	Test voltage
Short circuit voltage		SEC:	N	Primary voltage Primary current Neutral
Power (kVA)		50 - 60 Hz	H-180°C	Applicable standard
Frequency		ZNO	3 kV	Protection rating
Insulation transformer symbol		IEC 60076	IP-XX	Cooling
Connection unit		Pcc= XXX W	η= XX %	ANXX
CE declaration of conformity	CE <small>Made in Spain</small>	Po= XXX W	Ucc= X %	Weight
Losses in short circuit			XXXX kg	
Losses when empty		AUTNXX		Reference
		SN:	AUTNXXXXXX	Serial number



AUTF SERIES

For voltage changes **800 V / 400 V**

Definition and applications

The AUTF series are three-phase autotransformers that can be used to reduce the output voltage of inverters from 800V to 400V. Thus achieving the working voltage required by the customer.



AUTFX

- IP00 protection rating.
- Power from 1 kVA to 2000 kVA.
- Total impregnated in anti-flash varnish.
- Hoisting elements included.

Technical features - standard model

Power	1 kVA to 2000 kVA
Standard voltage	800 V // 400 V
Standard frequency	50-60 Hz
Connection unit	YNO
Windings	Class HC-200 °C
Insulators	Class F - 155 °C ≤ 80 kVA Class H - 180 °C ≥ 100 kVA <small>*More information in Technical Appendix (T.A.1)</small>
Class	I
Altitude	1000 m
Enclosure colour	RAL 7035
IP rating	IP00 (AUTFX) IP23 (AUTFW) IP54 / 65 (AUTFZ)
IK rating	IK08 (AUTFW) IK10 (AUTFZ)
Paint class (ISO 12944)	C3 (AUTFW) C4 (AUTFZ)
Room temperature	45 °C
Standards	IEC/EN 61558, CE up to 31.5 kVA IEC/EN 60076, CE from 40 kVA
Test voltage	3 kV (1 min., 50 Hz)
Inrush	< 12 In
Ucc	≤ 4 %
K factor	4
Operation	Continuous
Cooling	AN (AUTFX) - ANAN (AUTFW / AUTFZ)

Manufacturing characteristics

- All the transformers are dipped in anti-flash varnish and then compacted in the furnace. This process increases the insulation grade, reduces noise and provides anti-moisture, waterproofed protection
- The high power transformers are manufactured with format cores and low loss properties, thus contributing to improving performance.
- All the transformers are checked automatically one by one and the compliance test report is created in accordance with the corresponding standard.



AUTFW

- IP23 rating (IK08).
- Power from 1 kVA to 2000 kVA.
- Metal box painted with RAL7035 polyester resin.
- High resistance to corrosion.
- Cable outlet with cable gland.
- Hoisting elements included.
- Detachable top and front cover.



AUTFZ

- IP54 rating / 65 (IK10).
- Power from 1 kVA to 2000 kVA.
- Metal box painted with RAL7035 polyester resin.
- High resistance to corrosion.
- Stuffing box cover for cable input depending on installation needs.
- Hoisting elements included.
- Detachable top cover.
- With silentblock.

Electrical diagram

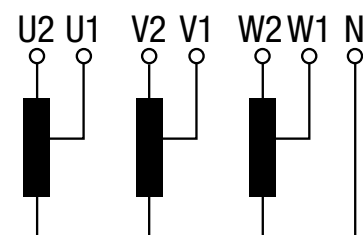

Connection

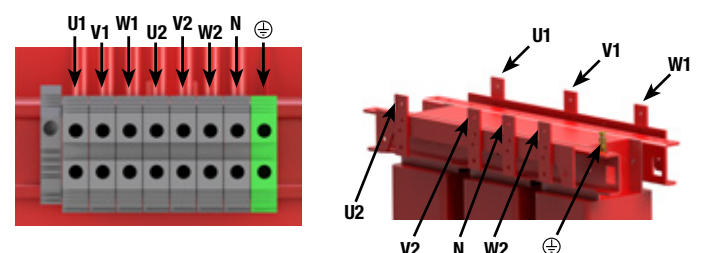



AUTF SERIES

For voltage changes **800 V / 400 V**

Terminal types

Terminals	Maximum cross-section conductor mm ²	Maximum tightening torque		AUTFX-AUTFW-AUTFZ				
				Power kVA				
		N-m	Lb-In	Entrada		Salida		
				From	To	From	To	
Power strip 1	Terminal 4	6	0,5	4,4	1	2	1	2
	Terminal 10	16	1,2	10,6	3,15	5	3,15	5
	Terminal 16	25	1,2	10,6	8	12,5	8	12,5
	Terminal 35	50	2,5	22,1	16	31,5	16	31,5
	Terminal 50	70	6	53,1	40	50	40	50
Power strip 2	Terminal 100	35	6,7	60	63	63	-	-
	Terminal 200	95	9	80	80	80	63	80
	Terminal 300	150	9	80	100	125	100	125
Connection plate	Plate 30 X 1	150	-	-	160	160	-	-
	Plate 40 X 1	150	-	-	200	250	160	160
	Plate 50 X 1	150	-	-	315	500	200	250
	Plate 60 X 2	150	-	-	630	800	315	500
	Plate 80 X 4	150	-	-	1000	1000	630	800
	Plate 100 X 4	150	-	-	-	-	1000	1000

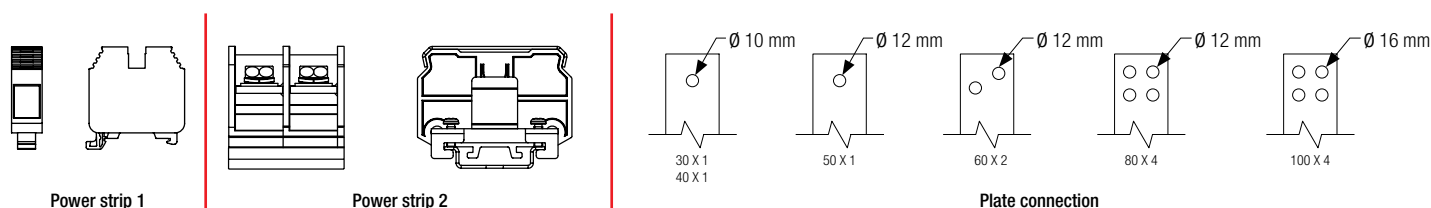

Datos teóricos - modelo estándar

Power kVA	Reference	Insulation class	Intensidad A		Protections A		Protections A		Noise dB
			800 V	400 V	Input (800 V)	Output (400 V)	Input (400 V)	Output (800 V)	
AUTFX									
1	AUTFX1	F	0.7	1.4	2 (D/aM)	1 (C/gG)	3 (D/aM)	0.7 (C/gG)	≤45
2	AUTFX2	F	1.4	2.9	3 (D/aM)	2.5 (C/gG)	10 (D/aM)	1 (C/gG)	≤45
3.15	AUTFX3.15	F	2.3	4.5	6 (D/aM)	4 (C/gG)	10 (D/aM)	2 (C/gG)	≤45
5	AUTFX5	F	3.6	7.2	10 (D/aM)	7 (C/gG)	16 (D/aM)	3 (C/gG)	≤45
8	AUTFX8	F	5.8	11.5	16 (D/aM)	10 (C/gG)	25 (D/aM)	5 (C/gG)	≤45
10	AUTFX10	F	7.2	14.4	16 (D/aM)	12 (C/gG)	32 (D/aM)	8 (C/gG)	≤45
12.5	AUTFX12.5	F	9	18	20 (D/aM)	12 (C/gG)	40 (D/aM)	8 (C/gG)	≤45
16	AUTFX16	F	11.5	23.1	25 (D/aM)	20 (C/gG)	50 (D/aM)	10 (C/gG)	≤45
20	AUTFX20	F	14.4	28.9	32 (D/aM)	25 (C/gG)	63 (D/aM)	12 (C/gG)	≤45
25	AUTFX25	F	18	36.1	40 (D/aM)	30 (C/gG)	40 (D/aM)	16 (C/gG)	≤45
31.5	AUTFX31.5	F	22.7	45.5	50 (D/aM)	40 (C/gG)	100 (D/aM)	20 (C/gG)	≤45
40	AUTFX40	F	28.9	57.7	63 (D/aM)	50 (C/gG)	125 (D/aM)	25 (C/gG)	≤55
50	AUTFX50	F	36.1	72.2	80 (D/aM)	60 (C/gG)	160 (D/aM)	32 (C/gG)	≤55
63	AUTFX63	F	45.5	90.9	100 (D/aM)	80 (C/gG)	200 (D/aM)	40 (C/gG)	≤55
80	AUTFX80	F	57.7	115.5	125 (D/aM)	100 (C/gG)	300 (D/aM)	50 (C/gG)	≤55
100	AUTFX100	H	72.2	144.3	160 (D/aM)	100 (C/gG)	300 (D/aM)	63 (C/gG)	≤55
125	AUTFX125	H	90.2	180.4	200 (D/aM)	160 (C/gG)	400 (D/aM)	80 (C/gG)	≤55
160	AUTFX160	H	115.5	230.9	300 (D/aM)	200 (C/gG)	500 (D/aM)	100 (C/gG)	≤55
200	AUTFX200	H	144.3	288.7	300 (D/aM)	250 (C/gG)	600 (D/aM)	100 (C/gG)	≤55
250	AUTFX250	H	180.4	360.8	400 (D/aM)	300 (C/gG)	800 (D/aM)	160 (C/gG)	≤65
315	AUTFX315	H	227.3	454.7	500 (D/aM)	400 (C/gG)	1000 (D/aM)	200 (C/gG)	≤65
400	AUTFX400	H	288.7	577.4	600 (D/aM)	500 (C/gG)	1200 (D/aM)	250 (C/gG)	≤65
500	AUTFX500	H	360.8	721.7	800 (D/aM)	600 (C/gG)	1600 (D/aM)	300 (C/gG)	≤65
630	AUTFX630	H	454.7	909.3	1000 (D/aM)	800 (C/gG)	2000 (D/aM)	400 (C/gG)	≤65
800	AUTFX800	H	577.4	1154.7	1200 (D/aM)	1000 (C/gG)	2500 (D/aM)	500 (C/gG)	≤65
1000	AUTFX1000	H	721.7	1443.4	1600 (D/aM)	1000 (C/gG)	2500 (D/aM)	600 (C/gG)	≤65
1250	AUTFX1250								
1600	AUTFX1600								
2000	AUTFX2000								



AUTF SERIES

For voltage changes **800 V / 400 V**

Datos teóricos - modelo estándar

Pow. kVA	Ref.	Insulation class	Intensidad A		Protections A		Protections A		Noise dB	Cable gland (AUTFW) Stuffing boxes (AUTFZ)	
			800 V	400 V	Input (800 V)	Output (400 V)	Input (400 V)	Output (800 V)		ø max. (mm)	Quantity
AUTFW											
1	AUTFW1	F	0.7	1.4	2 (D/aM)	1 (C/gG)	3 (D/aM)	0.7 (C/gG)	≤45	14	2
2	AUTFW2	F	1.4	2.9	3 (D/aM)	2.5 (C/gG)	10 (D/aM)	1 (C/gG)	≤45	14	2
3.15	AUTFW3.15	F	2.3	4.5	6 (D/aM)	4 (C/gG)	10 (D/aM)	2 (C/gG)	≤45	14	2
5	AUTFW5	F	3.6	7.2	10 (D/aM)	7 (C/gG)	16 (D/aM)	3 (C/gG)	≤45	14	2
8	AUTFW8	F	5.8	11.5	16 (D/aM)	10 (C/gG)	25 (D/aM)	5 (C/gG)	≤45	18	2
10	AUTFW10	F	7.2	14.4	16 (D/aM)	12 (C/gG)	32 (D/aM)	8 (C/gG)	≤45	18	2
12.5	AUTFW12.5	F	9	18	20 (D/aM)	12 (C/gG)	40 (D/aM)	8 (C/gG)	≤45	18	2
16	AUTFW16	F	11.5	23.1	25 (D/aM)	20 (C/gG)	50 (D/aM)	10 (C/gG)	≤45	18	2
20	AUTFW20	F	14.4	28.9	32 (D/aM)	25 (C/gG)	63 (D/aM)	12 (C/gG)	≤45	25	4
25	AUTFW25	F	18	36.1	40 (D/aM)	30 (C/gG)	40 (D/aM)	16 (C/gG)	≤45	25	4
31.5	AUTFW31.5	F	22.7	45.5	50 (D/aM)	40 (C/gG)	100 (D/aM)	20 (C/gG)	≤45	25	4
40	AUTFW40	F	28.9	57.7	63 (D/aM)	50 (C/gG)	125 (D/aM)	25 (C/gG)	≤55	32	4
50	AUTFW50	F	36.1	72.2	80 (D/aM)	60 (C/gG)	160 (D/aM)	32 (C/gG)	≤55	32	4
63	AUTFW63	F	45.5	90.9	100 (D/aM)	80 (C/gG)	200 (D/aM)	40 (C/gG)	≤55	32	4
80	AUTFW80	F	57.7	115.5	125 (D/aM)	100 (C/gG)	300 (D/aM)	50 (C/gG)	≤55	32	4
100	AUTFW100	H	72.2	144.3	160 (D/aM)	100 (C/gG)	300 (D/aM)	63 (C/gG)	≤55	32	8
125	AUTFW125	H	90.2	180.4	200 (D/aM)	160 (C/gG)	400 (D/aM)	80 (C/gG)	≤55	32	8
160	AUTFW160	H	115.5	230.9	300 (D/aM)	200 (C/gG)	500 (D/aM)	100 (C/gG)	≤55	32	8
200	AUTFW200	H	144.3	288.7	300 (D/aM)	250 (C/gG)	600 (D/aM)	100 (C/gG)	≤55	32	8
250	AUTFW250	H	180.4	360.8	400 (D/aM)	300 (C/gG)	800 (D/aM)	160 (C/gG)	≤65	32	8
315	AUTFW315	H	227.3	454.7	500 (D/aM)	400 (C/gG)	1000 (D/aM)	200 (C/gG)	≤65	44	8
400	AUTFW400	H	288.7	577.4	600 (D/aM)	500 (C/gG)	1200 (D/aM)	250 (C/gG)	≤65	44	8
500	AUTFW500	H	360.8	721.7	800 (D/aM)	600 (C/gG)	1600 (D/aM)	300 (C/gG)	≤65	44	8
630	AUTFW630	H	454.7	909.3	1000 (D/aM)	800 (C/gG)	2000 (D/aM)	400 (C/gG)	≤65	44	8
800	AUTFW800	H	577.4	1154.7	1200 (D/aM)	1000 (C/gG)	2500 (D/aM)	500 (C/gG)	≤65	44	8
1000	AUTFW1000	H	721.7	1443.4	1600 (D/aM)	1000 (C/gG)	2500 (D/aM)	600 (C/gG)	≤65	44	8
1250	AUTFW1250										
1600	AUTFW1600										
2000	AUTFW2000										
AUTFZ											
1	AUTFZ1	F	0.7	1.4	2 (D/aM)	1 (C/gG)	3 (D/aM)	0.7 (C/gG)	≤45	10 - 14	2
2	AUTFZ2	F	1.4	2.9	3 (D/aM)	2.5 (C/gG)	10 (D/aM)	1 (C/gG)	≤45	10 - 14	2
3.15	AUTFZ3.15	F	2.3	4.5	6 (D/aM)	4 (C/gG)	10 (D/aM)	2 (C/gG)	≤45	10 - 14	2
5	AUTFZ5	F	3.6	7.2	10 (D/aM)	7 (C/gG)	16 (D/aM)	3 (C/gG)	≤45	18 - 25	2
8	AUTFZ8	F	5.8	11.5	16 (D/aM)	10 (C/gG)	25 (D/aM)	5 (C/gG)	≤45	18 - 25	2
10	AUTFZ10	F	7.2	14.4	16 (D/aM)	12 (C/gG)	32 (D/aM)	8 (C/gG)	≤45	18 - 25	2
12.5	AUTFZ12.5	F	9	18	20 (D/aM)	12 (C/gG)	40 (D/aM)	8 (C/gG)	≤45	18 - 25	2
16	AUTFZ16	F	11.5	23.1	25 (D/aM)	20 (C/gG)	50 (D/aM)	10 (C/gG)	≤45	18 - 25	2
20	AUTFZ20	F	14.4	28.9	32 (D/aM)	25 (C/gG)	63 (D/aM)	12 (C/gG)	≤45	18 - 25	2
25	AUTFZ25	F	18	36.1	40 (D/aM)	30 (C/gG)	40 (D/aM)	16 (C/gG)	≤45	18 - 25	2
31.5	AUTFZ31.5	F	22.7	45.5	50 (D/aM)	40 (C/gG)	100 (D/aM)	20 (C/gG)	≤45	22 - 32	2
40	AUTFZ40	F	28.9	57.7	63 (D/aM)	50 (C/gG)	125 (D/aM)	25 (C/gG)	≤50	22 - 32	2
50	AUTFZ50	F	36.1	72.2	80 (D/aM)	60 (C/gG)	160 (D/aM)	32 (C/gG)	≤50	22 - 32	2
63	AUTFZ63	F	45.5	90.9	100 (D/aM)	80 (C/gG)	200 (D/aM)	40 (C/gG)	≤50	22 - 32	2
80	AUTFZ80	F	57.7	115.5	125 (D/aM)	100 (C/gG)	300 (D/aM)	50 (C/gG)	≤50	22 - 32	2
100	AUTFZ100	H	72.2	144.3	160 (D/aM)	100 (C/gG)	300 (D/aM)	63 (C/gG)	≤50	22 - 32	2
125	AUTFZ125	H	90.2	180.4	200 (D/aM)	160 (C/gG)	400 (D/aM)	80 (C/gG)	≤50	22 - 32	2
160	AUTFZ160	H	115.5	230.9	300 (D/aM)	200 (C/gG)	500 (D/aM)	100 (C/gG)	≤50	22 - 32	2
200	AUTFZ200	H	144.3	288.7	300 (D/aM)	250 (C/gG)	600 (D/aM)	100 (C/gG)	≤55	22 - 32	2
250	AUTFZ250	H	180.4	360.8	400 (D/aM)	300 (C/gG)	800 (D/aM)	160 (C/gG)	≤55	22 - 32	2
315	AUTFZ315	H	227.3	454.7	500 (D/aM)	400 (C/gG)	1000 (D/aM)	200 (C/gG)	≤60	34 - 44	2
400	AUTFZ400	H	288.7	577.4	600 (D/aM)	500 (C/gG)	1200 (D/aM)	250 (C/gG)	≤60	34 - 44	2
500	AUTFZ500	H	360.8	721.7	800 (D/aM)	600 (C/gG)	1600 (D/aM)	300 (C/gG)	≤65	34 - 44	2
630	AUTFZ630	H	454.7	909.3	1000 (D/aM)	800 (C/gG)	2000 (D/aM)	400 (C/gG)	≤65	34 - 44	2
800	AUTFZ800	H	577.4	1154.7	1200 (D/aM)	1000 (C/gG)	2500 (D/aM)	500 (C/gG)	≤65	34 - 44	2
1000	AUTFZ1000	H	721.7	1443.4	1600 (D/aM)	1000 (C/gG)	2500 (D/aM)	600 (C/gG)	≤65	34 - 44	2
1250	AUTFZ1250										
1600	AUTFZ1600										
2000	AUTFZ2000										





AUTF SERIES

For voltage changes 800 V / 400 V

Measurements

Power kVA	Reference	External dimensions mm			Fastening elements mm			Weight kg
		A	B	C	D	E	Ø	
AUTFX								
1	AUTFX1	150	94	178	66	125	6	5.9
2	AUTFX2	180	94	203	76	150	6	9.5
3.15	AUTFX3.15	240	145	253	125	200	9	20
5	AUTFX5	300	124	303	115	250	9	23.9
8	AUTFX8	300	124	303	115	250	9	36
10	AUTFX10	300	164	303	155	250	9	40.4
12.5	AUTFX12.5	360	144	353	122	300	11	55
16	AUTFX16	360	164	353	142	300	11	67
20	AUTFX20	420	170	419	136	350	11	78
25	AUTFX25	420	190	419	156	350	11	94
31.5	AUTFX31.5	480	250	480	144	400	11	105
40	AUTFX40	480	270	480	164	400	11	125
50	AUTFX50	480	290	480	184	400	11	145
63	AUTFX63	480	310	480	204	400	11	162
80	AUTFX80	670	280	615	170	426	13	191
100	AUTFX100	670	300	615	190	426	13	233
125	AUTFX125	670	320	690	210	426	13	277
160	AUTFX160	670	340	690	230	426	13	320
200	AUTFX200	670	360	690	250	426	13	368
250	AUTFX250	785	550	880	460	472	17	462
315	AUTFX315	785	550	880	460	472	17	560
400	AUTFX400	785	550	880	460	472	17	660
500	AUTFX500	1016	550	1080	460	690	17	808
630	AUTFX630	1070	550	1220	460	690	17	1000
800	AUTFX800	1070	550	1220	460	690	17	1092
1000	AUTFX1000	1300	550	1350	460	800	17	1658
1250	AUTFX1250	1300	600	1350	460	800	17	2000
1600	AUTFX1600	1300	700	1350	510	800	17	2413
2000	AUTFX2000	1300	800	1350	560	800	17	2993

Power kVA	Reference	External dimensions mm			Fastening elements mm			Weight kg
		A	B	C	D	E	Ø	
AUTFW								
1	AUTFW1	194	175	220	165	100	6	7.6
2	AUTFW2	240	190	250	180	150	6	13.2
3.15	AUTFW3.15	240	190	250	180	150	6	24.8
5	AUTFW5	315	230	315	205	200	6	28.8
8	AUTFW8	385	260	384	245	250	6	40.8
10	AUTFW10	385	260	384	245	250	6	45.2
12.5	AUTFW12.5	458	340	500	300	300	12	61
16	AUTFW16	458	340	500	300	300	12	73
20	AUTFW20	528	418	644	375	345	12	89
25	AUTFW25	528	418	644	375	345	12	106
31.5	AUTFW31.5	597	415	710	375	345	12	117
40	AUTFW40	597	415	710	375	345	12	137
50	AUTFW50	597	415	710	375	345	12	157
63	AUTFW63	597	415	710	375	345	12	174
80	AUTFW80	795	550	970	500	415	12	237
100	AUTFW100	795	550	970	500	415	12	279
125	AUTFW125	795	550	970	500	415	12	323
160	AUTFW160	795	550	970	500	415	12	366
200	AUTFW200	795	550	970	500	415	12	414
250	AUTFW250	970	670	1250	582	470	18	514
315	AUTFW315	970	670	1250	582	470	18	612
400	AUTFW400	970	670	1250	582	470	18	754
500	AUTFW500	1200	760	1555	672	690	18	855
630	AUTFW630	1200	760	1555	672	690	18	1093
800	AUTFW800	1200	760	1555	672	690	18	1185
1000	AUTFW1000	1530	1000	1880	900	800	20	1808
1250	AUTFW1250	1530	1000	1880	900	800	20	2149
1600	AUTFW1600	1530	1000	1880	900	800	20	2563
2000	AUTFW2000	1530	1000	1880	900	800	20	3143

AUTFX IP00

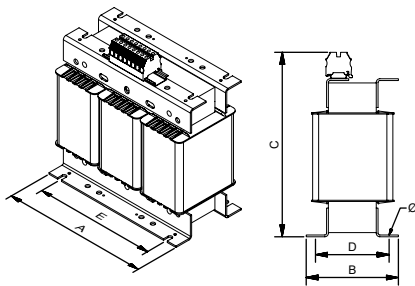

Up to 50 kVA

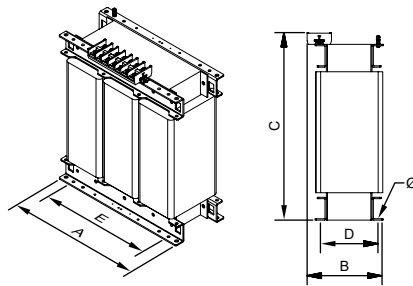

From 63 kVA to 125 kVA

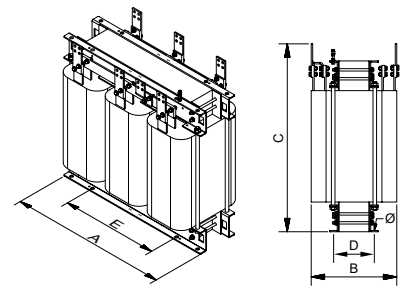

From 160 kVA

AUTFW IP23

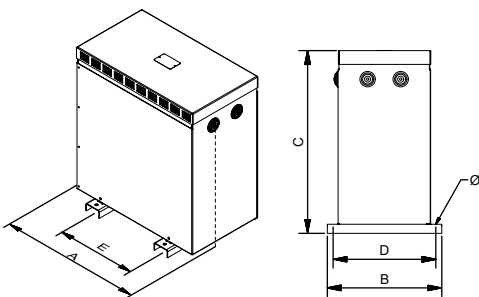

Up to 80 kVA

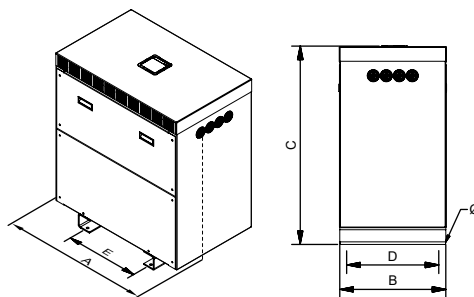

From 100 kVA



Sectioned



AUTF SERIES

For voltage changes **800 V / 400 V**

Medidas

Power kVA	Reference	External dimensions mm			Fastening elements mm			Weight kg
		A	B	C	D	E	Ø	
AUTFZ								
1	AUTFZ1	330	284	463	230	200	11	19,5
2	AUTFZ2	330	284	463	230	200	11	24
3.15	AUTFZ3.15	510	362	689	320	250	11	37
5	AUTFZ5	510	362	689	320	250	11	40
8	AUTFZ8	510	362	689	320	250	11	61
10	AUTFZ10	510	362	689	320	250	11	76
12.5	AUTFZ12.5	510	362	689	320	250	11	87,5
16	AUTFZ16	694	413	764	370	350	11	118
20	AUTFZ20	694	413	764	370	350	11	134
25	AUTFZ25	694	413	764	370	350	11	145
31.5	AUTFZ31.5	694	413	764	370	350	11	165
40	AUTFZ40	694	413	764	370	350	11	185
50	AUTFZ50	694	413	764	370	350	11	202
63	AUTFZ63	694	413	764	370	350	11	220
80	AUTFZ80	890	560	1148	520	426	13	251
100	AUTFZ100	890	560	1148	520	426	13	295
125	AUTFZ125	890	560	1148	520	426	13	340
160	AUTFZ160	890	560	1148	520	426	13	383
200	AUTFZ200	890	560	1148	520	426	13	433
250	AUTFZ250	972	740	1480	660	470	17	551
315	AUTFZ315	972	740	1480	660	470	17	628
400	AUTFZ400	972	740	1480	660	470	17	797
500	AUTFZ500	1394	870	1762	810	690	17	1186
630	AUTFZ630	1394	870	1762	810	690	17	1278
800	AUTFZ800	1394	870	1762	810	690	17	1933
1000	AUTFZ1000	1640	1226	1770	1110	800	17	2275
1250	AUTFZ1250	1640	1226	1770	1110	800	17	2688
1600	AUTFZ1600	1640	1226	1770	1110	800	17	3268
2000	AUTFZ2000	1640	1226	1770	1110	800	17	3848

AUTFZ IP54 / 65

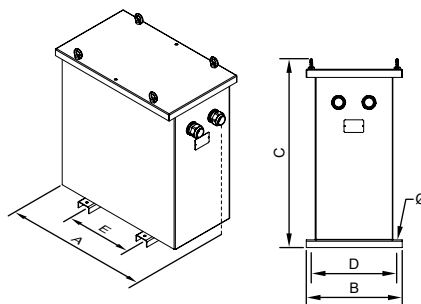



AUTF SERIES

For voltage changes **800 V / 400 V**

On-request manufacturing options (please see prices)

Power	From 1 kVA to 2000 kVA
Windings	Copper or aluminium
Voltage	From 1 V to 12 kV
Frequency	From 50 Hz to 400 Hz
IP rating	IP00, IP20, IP23, IP31, IP42, IP54, IP55 and IP65
IK rating	IK08 and IK10
Room temperature	Up to 60 °C
Locks	Screw, key
Short circuit voltage	From 2% to 9%
Operation	Intermittent, continuous
Cooling	Natural, forced ventilation
Electrostatic shield	Up to three shields
Class	I, II
Altitude	Up to 4000 m
Protections	In both primary and secondary (figure 1)
Temperature sensors	PT100 (figure 2), PTC (figure 3) or bimetallic
Network analyser	(Figure 5)
Anti condensation system	Higrostat
Heating system	Heating elements
External protection	Anti-flash varnish, metallic or stainless steel enclosure
Transportation and hoisting	Wheels (figure 6), lifting points
Paint	C3, C4, C5, different RAL
Feature plate	High generation polymer or stainless steel (figure 7)
Anti vibration system	Silentblock
Adjustment	-10%; -7.5%; -5%; -2.5%; +2.5%; +5%; +7.5%; +10% With bridges (figure 8) or selector (figure 9)
Certified	CE, DNV-GL, BV, UL (insulation) and POLYLUX laboratory
Climate class / environment / fire	Up to C2-E2-F1



Figure 1



Figure 2



Figure 3



Figure 4



Figure 5



Figure 6



Figure 7



Figure 8



Figure 9



AUTF SERIES

For voltage changes 800 V / 400 V

Feature plate structure

Plastic label up to 80 kVA:

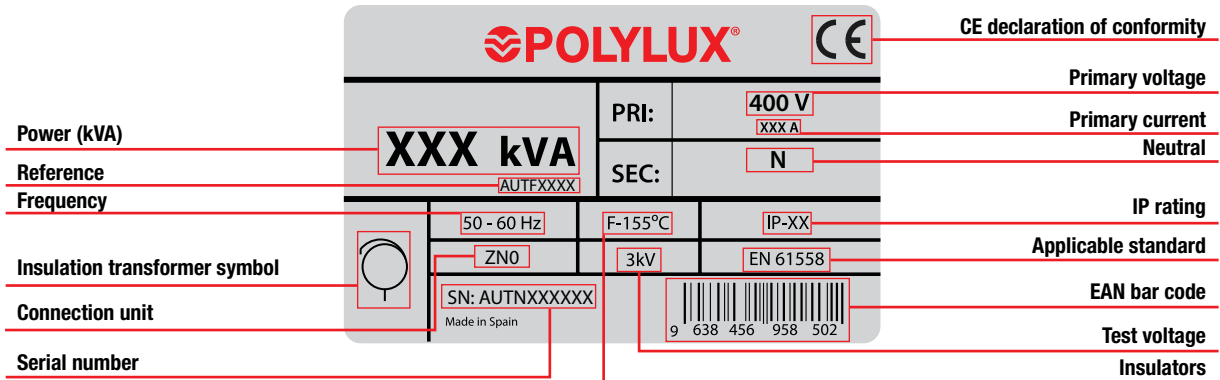

Stainless steel label from 100 kVA:

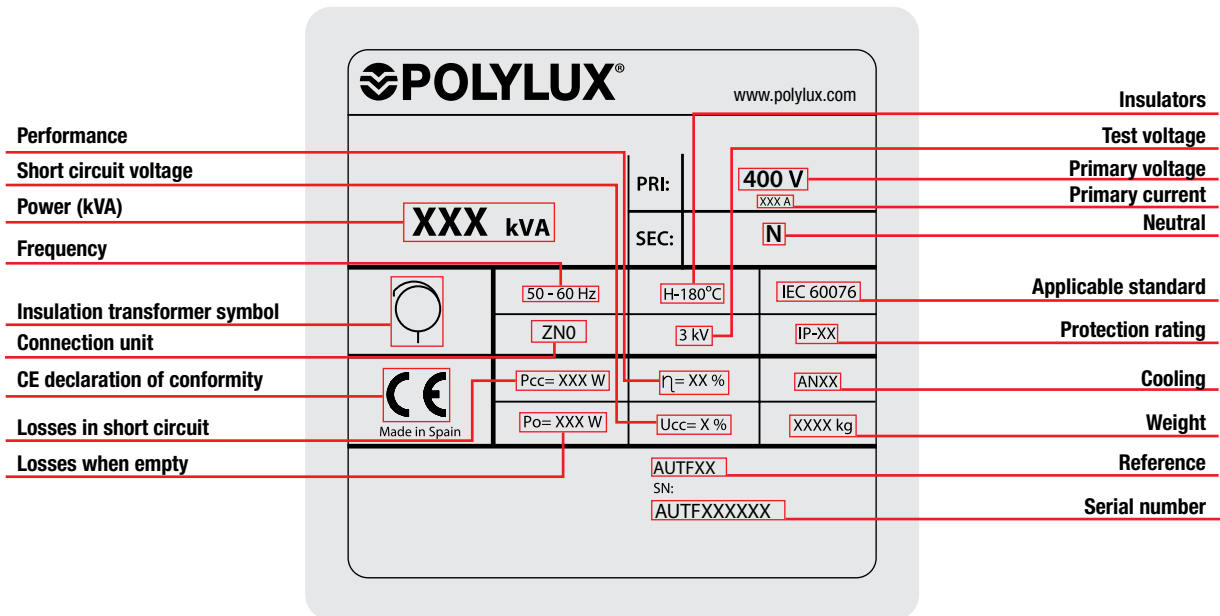

EV SERIES

With manual control for single-phase networks · Input **230 V** · Output **0 V to 250 V**

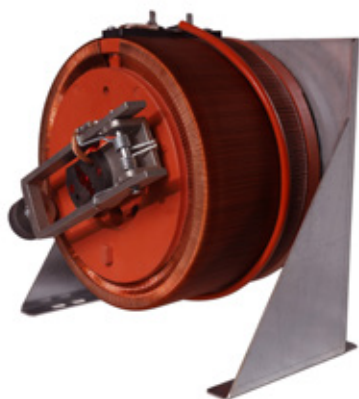

Definition and applications

The EV series are single-phase voltage converters with manual control. Their main applications are:

- Variable power supply in laboratories.
- Light technology.
- Withstand voltage equipment.
- Temperature control with resistive loads.
- Voltage stabilisers.
- Speed control in electric motors.
- Adjustment of other fixed transformers.
- Galvanic control.

Manufacturing characteristics

Unbreakable electro-graphite carbon brushes for rolling motors. Gentle movement brushes with an internal bearing system.

All the converters are checked automatically one by one and the compliance report is created based on the respective standard.

Technical features - standard model

Power	300 VA to 15000 VA
Protection rating	IP00
Cooling	AN

Measurements

Power VA	Reference	A	B	C	D	E	F	Weight kg
300	EV300	140	110	40	10	30	M6	4
1000	EV1000	155	155	50	10	30	M6	8
1500	EV1500	155	170	50	10	30	M6	11
2000	EV2000	155	170	50	10	30	M6	12
2500	EV2500	155	190	50	10	30	M6	14
3500	EV3500	160	205	85	10	30	116	18
4500	EV4500	185	205	85	10	30	116	21
5000	EV5000	185	205	85	10	30	116	22
6500	EV6500	200	235	15	80	200	M6	33
7500	EV7500	200	250	15	80	220	M6	37
10000	EV10000	220	250	15	80	220	M6	41
12500	EV12500	230	305	15	80	240	M6	60
15000	EV15000	245	305	15	80	240	M6	68

Connection

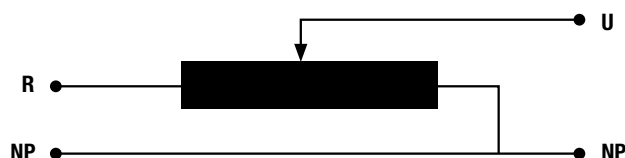

From EV300 to EV2500

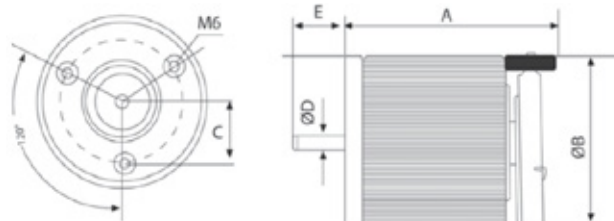

From EV3500 to EV5000

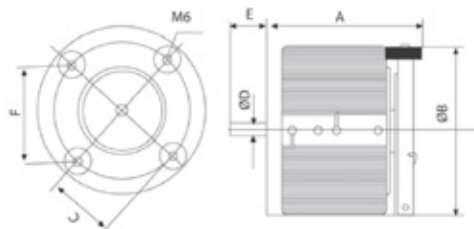

From EV6500 to EV15000

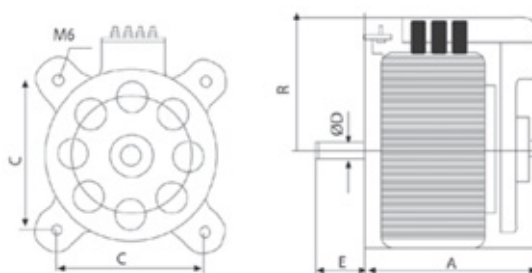

EVM SERIES

With motorised control for single-phase networks · Input **230 V** · Output **0 V a 250 V**

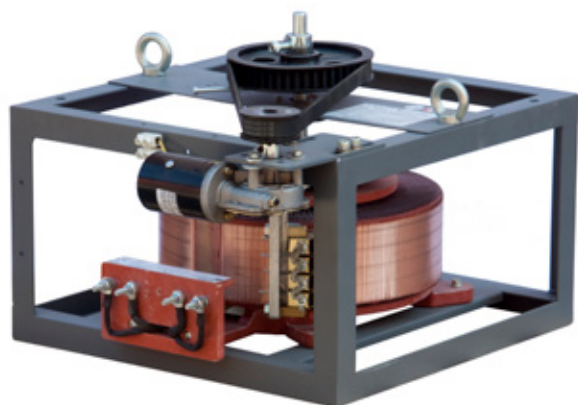

Definition and applications

The EMV series are single-phase voltage converters with motorised control. Their main applications are:

- Variable power supply in laboratories.
- Light technology.
- Withstand voltage equipment.
- Temperature control with resistive loads.
- Voltage stabilisers.
- Speed control in electric motors.
- Adjustment of other fixed transformers.
- Galvanic control.

Manufacturing characteristics

All the versions are made up of:

- A converter base.
- 12 Vdc motor / 30 VA to 5000 VA - FCPB4 option for supplying the motor.
- 24 Vdc motor / 30 VA from 6500 VA - FCP2 option for supplying the motor.
- Limit switches.
- Motor terminal blocks.

All the converters are checked automatically one by one and the compliance report is created based on the respective standard.

Technical features - standard model

Power	1000 VA to 15000 VA
Protection rating	IP00
Cooling	AN

Measurements

Power VA	Reference	External dimensions mm			Weight kg
		A	B	C	
1000	EVM1000	200	200	320	9
1500	EVM1500	200	200	325	12
2000	EVM2000	200	200	325	13
2500	EVM2500	200	200	330	16
3500	EVM3500	235	255	330	19
4500	EVM4500	235	255	340	23
5000	EVM5000	235	255	340	24
6500	EVM6500	330	420	530	41
7500	EVM7500	330	420	530	45
10000	EVM10000	330	420	530	53
12500	EVM12500	370	480	600	70
15000	EVM15000	370	480	600	77

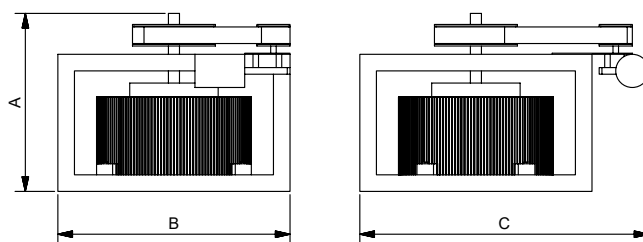

EVT SERIES

With manual control for three-phase networks · Input 400 V · Output 0 V to 440 V



Definition and applications

The EVT series are three-phase voltage converters with manual control. Their main applications are:

- Variable power supply in laboratories.
- Light technology.
- Withstand voltage equipment.
- Temperature control with resistive loads.
- Voltage stabilisers.
- Speed control in electric motors.
- Adjustment of other fixed transformers.
- Galvanic control.

Manufacturing characteristics

Unbreakable electro-graphite carbon brushes for rolling motors. Gentle movement brushes with an internal bearing system. All the converters are checked automatically one by one and the compliance report is created based on the respective standard.

Technical features - standard model

Power	3 kVA to 150 kVA
Protection rating	IP00
Cooling	AN

Connection

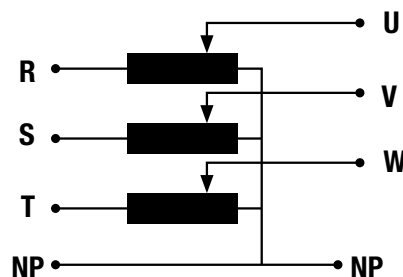

Measurements

Power kVA	Reference	A	B	H	D	E	Weight kg
3	EVT3	180	160	520	10	10	28
4.6	EVT4.5	180	160	520	10	10	38
6	EVT6	180	160	520	10	10	39
7.5	EVT7.5	180	160	520	10	10	49
10.5	EVT10.5	220	190	560	10	10	57
13.5	EVT13.5	220	190	560	10	10	70
15	EVT15	220	190	560	10	10	73
19.5	EVT19.5	420	420	820	15	150	117
22.5	EVT22.5	420	420	820	15	150	129
30	EVT30	420	420	820	15	150	142
37.5	EVT37.5	480	480	880	15	150	202
45	EVT45	480	480	880	15	150	225
60	EVT60	840	580	880	-	-	321
75	EVT75	960	640	980	-	-	425
90	EVT90	960	640	980	-	-	467
120	EVT120	1260	680	1150	-	-	714
150	EVT150	1440	740	1270	-	-	936

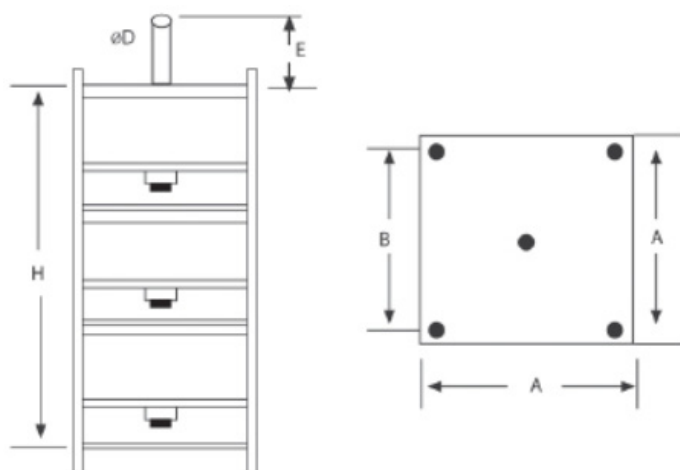

EVTM SERIES

With motorised control for three-phases networks · Input 400 V · Output 0 V to 440 V



Definition and applications

The EVTM series are three-phase voltage converters with motorised control. Their main applications are:

- Variable power supply in laboratories.
- Light technology.
- Withstand voltage equipment.
- Temperature control with resistive loads.
- Voltage stabilisers.
- Speed control in electric motors.
- Adjustment of other fixed transformers.
- Galvanic control.

Manufacturing characteristics

All the versions are made up of:

- A converter base.
- 24 Vdc motor / 30 VA - FCP2 option for supplying the motor.
- Limit switches.
- Motor terminal blocks.

All the converters are checked automatically one by one and the compliance report is created based on the respective standard.

Technical features - standard model

Power	3 kVA to 150 kVA
Protection rating	IP00
Cooling	AN

Measurements

Power kVA	Reference	External dimensions mm			Weight kg
		A	B	C	
3	EVTM3	655	235	220	29
4.5	EVTM4.5	655	235	220	39
6	EVTM6	655	235	220	40
7.5	EVTM7.5	655	235	220	50
10.5	EVTM10.5	675	250	260	58
13.5	EVTM13.5	725	250	260	71
15	EVTM15	725	250	260	74
19.5	EVTM19.5	830	420	530	120
22.5	EVTM22.5	830	420	530	132
30	EVTM30	830	420	530	156
37.5	EVTM37.5	930	480	600	208
45	EVTM45	930	480	600	229
60	EVTM60	880	580	840	321
75	EVTM75	980	640	960	425
90	EVTM90	980	640	960	467
120	EVTM120	1150	680	1260	714
90	EVTM150	1270	740	1440	936

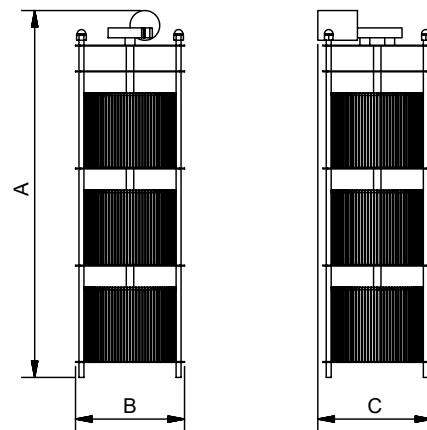

VK SERIES

Single-phase · Input $230\text{ V} \pm 20\%$ - Output $230\text{ V} \pm 1\%$



Technical features - standard model

Power	5 kVA to 50 kVA
Standard voltage	Input: $230\text{ V} \pm 20\%$ // Output: $230\text{ V} \pm 1\%$
Standard frequency	50-60 Hz
Response speed	10 V/s
Enclosure colour	RAL 7035
IP rating	IP20
Paint class (ISO 12944)	C3
Operating temperature	From -10 °C to 60 °C
Relative humidity	< 90 %
Performance	> 98 %
Standards	IEC/EN/UNE-EN 61439, CE
Operation	Continuous
Cooling	ANAN

Definition and applications

With the single-phase automatic voltage stabilizer, a stable output voltage is achieved with a variable input voltage (power company supply or other generator). The goal is to power industrial equipment that requires a stable voltage input. Valid for installations where line tension experiences fluctuations throughout the day. Not valid for sudden changes in tension such as company maneuvers.

Manufacturing characteristics

All the VK models have:

- Built-in BY-PASS
 - Automatic control of the regulating motor
 - Digital current and voltage indicators
 - Maximum overload 200% 2 seconds.
 - Visual and audible alarms
 - Protections:
 - Against over temperatures.
 - Against short circuits.
 - Against over currents and overloads.
 - Phase failure and loss of protection per phase.
 - MCB input.
 - Outside stabilization margins.
 - All the stabilisers are checked automatically one by one and the compliance report is created based on the respective standard.
- In case of galvanic separation consult special isolating transformers TT and TK models:
- Independent installation in front of the stabilizer in IP23 grade.
 - These transformers will be prepared to withstand an overvoltage of the +20% or the selected special margin.
 - Possibility of incorporating electrostatic screen
 - Possibility of incorporating overvoltage arresters.

VK SERIES

Single-phase · Input **230 V ± 20 %** - Output **230 V ± 1 %**

Theoretical data - standard model

Power kVA	Reference	Current A
VK		
5	VK5	21.7
6,3	VK6.3	27.4
8	VK8	34.8
10	VK10	43.5
16	VK16	69.6
20	VK20	87
25	VK25	108.7
30	VK30	130.4
40	VK40	173.9
50	VK50	217.4

Measurements

Power kVA	Reference	External dimensions mm			Weight kg
		A	B	C	
VK					
5	VK5	480	360	270	30
6,3	VK6.3	530	430	300	46
8	VK8	530	430	300	46
10	VK10	530	430	300	46
16	VK16	570	470	320	72
20	VK20	570	470	320	72
25	VK25	570	570	880	130
30	VK30	570	570	880	130
40	VK40	570	670	930	200
50	VK50	570	670	930	200

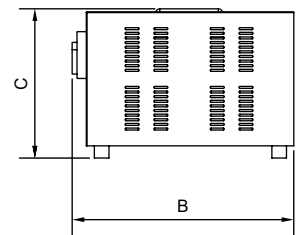
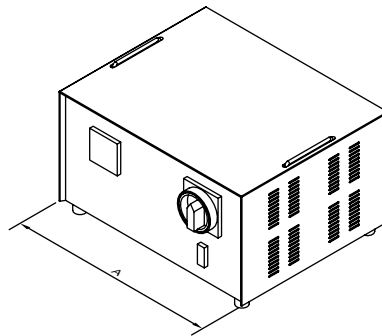

Feature plate structure

	POLYLUX®			CE declaration of conformity
Power (kVA)	XXX kVA		PRI: 230 V ± 20% <small>XXX A</small>	Primary voltage (V) Primary current
Reference	<small>VKXXXXX</small>		SEC: 230 V ± 1% <small>XXX A</small>	Secondary voltage Secondary current
Frequency	50 - 60 Hz		IP20	IP rating
Serial number	<small>SN: VKXXXXXXXX</small>		3/0.5 kV	Applicable standard
	<small>Made in Spain</small>		EN 61439	EN bar code
			9 638 456 958 602	Test voltage

On-request manufacturing options (please see prices)

Power	From 5 kVA to 50 kVA
-------	----------------------

VTF SERIES

Three-phase phase control · Input $400\text{ V} \pm 20\%$ - Output $400\text{ V} \pm 1\%$



Definition and applications

With the three-phase automatic voltage stabilizer, a stable output voltage is achieved with a variable input voltage (power company supply or other generator). The goal is to power industrial equipment that requires a stable voltage input. Valid for installations where line tension experiences fluctuations throughout the day. Not valid for sudden changes in tension such as company maneuvers.

Manufacturing characteristics

All the VTF models have:

- Built-in BY-PASS
- Automatic control of the regulating motor.
- Digital current and voltage indicators
- Maximum overload 200% 2 seconds.
- Visual and audible alarms
- Protections:
 - Against over temperatures.
 - Against short circuits.
 - Against over currents and overloads.
 - Phase failure and loss of protection per phase.
 - MCB input.
 - Outside stabilization margins.
- All the stabilisers are checked automatically one by one and the compliance report is created based on the respective standard.

In case of galvanic separation consult special isolating transformers TT and TK models:

- Independent installation in front of the stabilizer in IP23 grade.
- These transformers will be prepared to withstand an overvoltage of the +20% or the selected special margin.
- Possibility of incorporating electrostatic screen
- Possibility of incorporating overvoltage arresters.

Technical features - standard model

Power	5 kVA to 150 kVA
Standard voltage	Input: $400\text{ V} \pm 20\%$ // Output: $400\text{ V} \pm 1\%$
Standard frequency	50-60 Hz
Response speed	10 V/s
Enclosure colour	RAL 7035
IP rating	IP20
Paint class (ISO 12944)	C3
Operating temperature	From -10 °C to 60 °C
Relative humidity	< 90 %
Performance	> 98 %
Standards	IEC/EN/UNE-EN 61439, CE
Operation	Continuous
Cooling	ANAN

VTF SERIES

Three-phase phase control · Input $400\text{ V} \pm 20\%$ - Output $400\text{ V} \pm 1\%$

Theoretical data - standard model

Power kVA	Reference	Current A
VTF		
5	VTF5	7.2
8	VTF8	11.5
10	VTF10	14.4
16	VTF16	23.1
20	VTF20	28.9
25	VTF25	36.1
31,5	VTF31.5	45.5
40	VTF40	57.7
50	VTF50	72.2
63	VTF63	90.9
80	VTF80	115.5
100	VTF100	144.3
125	VTF125	180.4
150	VTF150	216.5

Measurements

Power kVA	Reference	External dimensions mm			Weight kg
		A	B	C	
VTF					
5	VTF5	520	500	1130	90
8	VTF8	520	500	1130	90
10	VTF10	520	500	1130	90
16	VTF16	520	500	1130	130
20	VTF20	520	500	1130	130
25	VTF25	620	500	1250	180
31,5	VTF31.5	620	500	1250	180
40	VTF40	620	500	1250	180
50	VTF50	770	660	1250	340
63	VTF63	770	660	1250	340
80	VTF80	770	660	1250	350
100	VTF100	770	660	1250	350
125	VTF125	980	800	1360	600
150	VTF150	980	800	1360	600

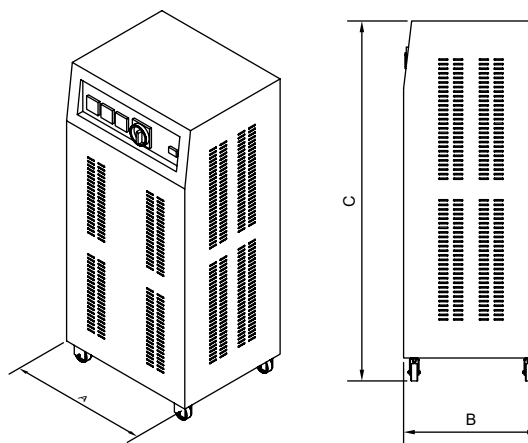

Feature plate structure

	POLYLUX®			CE declaration of conformity
Power (kVA)	XXX kVA		PRI: $400\text{ V} \pm 20\%$ <small>XXX A</small>	Primary voltage (V)
Reference	<small>VTFXXX</small>		SEC: $400\text{ V} \pm 1\%$ <small>XXX A</small>	Primary current
Frequency	50 - 60 Hz			Secondary voltage
			IP20	Secondary current
		3/0.5 kV	EN 61439	IP rating
Serial number	SN: VTFXXXXXX			Applicable standard
	<small>Made in Spain</small>		9 638 456 958 602	EAN bar code
				Test voltage

On-request manufacturing options (please see prices)

Power **To 600 kVA**



SPECIAL

Most of the products requested by our customers are custom-engineered. This is due to the need for specific voltages, powers, losses, working temperatures, etc. in different parts of the world for different types of installations.

Today, PolyLux is able to offer any product within the following specifications:

Single and three-phase encapsulated transformers with maximum voltages of 12 kV and three-phase products with powers up to 1000 kVA, as well as resin-encapsulated products up to 400 kVA. PolyLux also has experience in manufacturing encapsulated single-phase high current transformers.



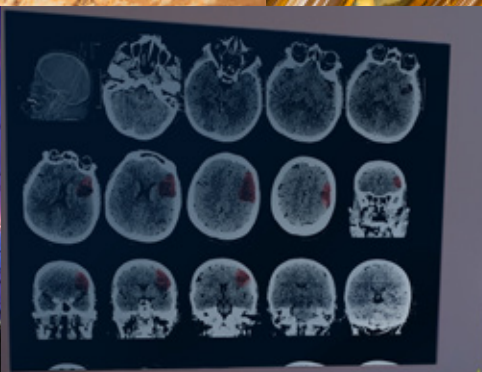

FABRICATIONS



Ratings

IP-00

Not protected from solids and water.

IP-20

Protected from solids over 12 mm in diameter, but not protected from water.

IP-23

Protected from solids over 12 mm in diameter and from water spray no more than 60° from the vertical.

IP-31

Protected from solids with a diameter greater than 2.5 mm and from vertically dripping water.

IP-42

Protected from solids with a diameter greater than 1.0 mm and from water spray less than 15° from the vertical.

IP-54

Protected from contact with external elements and from dust ingress (deposits in quantities harmful to the appliance) and from water spray in any direction.

IP-65

Fully protected from dust ingress and from any contact. Protected from pressure water jets in any direction.

Advantages of resin encapsulation



High reliability in unfavourable vibratory conditions.



Protection from damp, corrosive environments.



Resistance to transient surge currents and harmonics.

Symbols



Isolation transformer.



Control and manoeuvre transformer.



Safety transformer.



Single-phase autotransformer.



Three-phase autotransformer.



Transformer for clinical use in accordance with IEC/EN 61558 standard.



Protection from dust.



Protection from water in any direction.



Ecological equipment: high performance and low losses.



Transformers for three-phase harmonic networks.



Equipment for clinical electrical installations.

Appendices

AT1-Insulators

Temperature increase (K) EN61558 / EN60076

Class	°C	ΔT °C K	Ta40 °C Tmax
B	130	80	120
F	155	100	140
H	180	120	160

AT2-Connection units

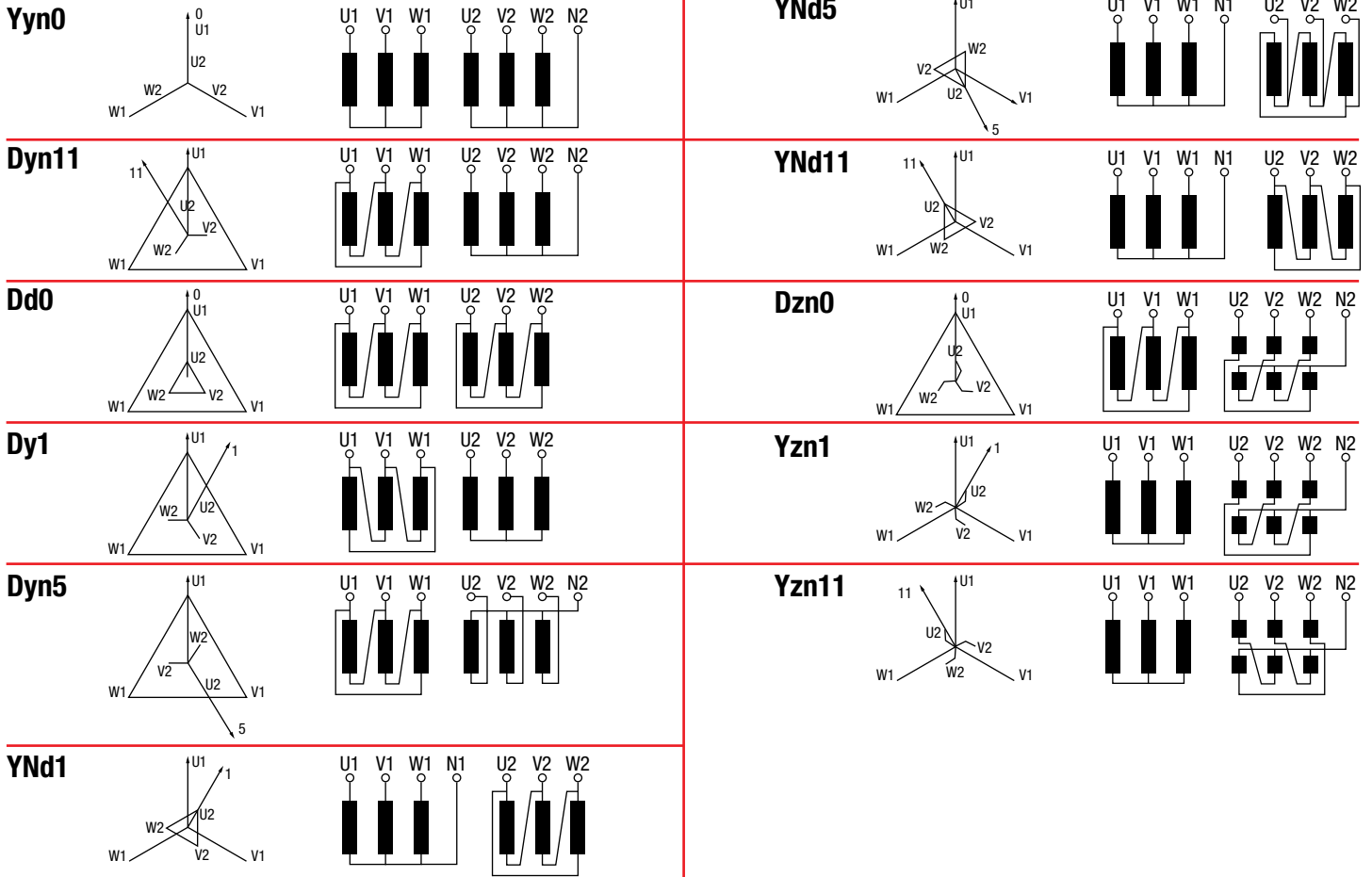

AT3- Table for the selection of conductors and protections for low power single-phase transformers

Calculation of maximum currents:

$$I_{\max} \text{ (A)} = \frac{\text{Power (VA)}}{\text{Voltage (V)}}$$

Based on the maximum current and voltage and depending on whether it is input or output for the protection, select the current equal to or higher than the one calculated in the table. For the output it is advisable to enter the standardised caliber lower than or equal to the calculated nominal current.

I _{max} (A)	Max. cross-section (mm ²)		Input protection (A)		Output protection (A)	
	Flexible	Rigid	MCB -> D Curve	aM Fuse	MCB -> C Curve	gG Fuse
0.1	0.5	0.5	-	0.2	-	0.1
0.15	0.5	0.5	-	0.3	-	0.15
0.2	0.5	0.5	-	0.4	-	0.2
0.25	0.5	0.5	-	0.5	-	0.25
0.3	0.5	0.5	-	0.6	-	0.3
0.4	0.5	0.5	1	1	-	0.4
0.5	0.5	1	1	1	-	0.5
0.6	0.5	1	2	2	-	0.6
0.7	0.5	1	2	2	-	0.7
0.8	0.5	1	2	2	-	0.8
1	0.5	1	2	2	1	1
1.5	0.5	1	3	3	-	1.6
2	1	1.5	4	4	2	2
2.5	1	1.5	6	6	-	2.5
3.5	1	1.5	10	10	3	3
4	1	1.5	10	10	4	4
5	1.5	2	10	10	-	5
6	1.5	2	16	16	6	6.3
7	1.5	2	16	16	-	8
8	2	2.5	16	16	-	8
9	2	2.5	20	20	-	8
10	2	2.5	20	20	10	10
12	2.5	4	25	25	-	12
15	2.5	4	32	32	16	12
20	4	---	40	40	20	20
25	4	---	50	50	25	25
30	6	---	63	63	32	32
40	8	---	80	80	40	40
50	10	---	100	100	50	50

Example:

For a PD with a power of 500 VA, input of 400 V and output of 230 V, first calculate the input current:

$$I_{\max} \text{ input} = \frac{500 \text{ VA}}{400 \text{ V}} = 1,25 \text{ A}$$

According to the table the highest I_{max} would be 1.5 A, so:

- Conductor: flexible, 0.5 mm² or rigid, 1 mm²
- Protection: MCB 3 A D Curve or 3 A aM Fuse

For the output, follow the same steps:

$$I_{\max} \text{ output} = \frac{500 \text{ VA}}{230 \text{ V}} = 2,17 \text{ A}$$

According to the table the highest I_{max} would be 2.5 A, so:

- Conductor: flexible, 1 mm² or rigid, 1.5 mm²

According to the table the lowest I_{max} would be 2 A, so:

- Protection: 2 A gG Fuse

AT4- Table for the selection of protections for high power single-phase and three-phase transformers

Calculation of maximum currents:

- Single-phase:
$$I_{\max} \text{ (A)} = \frac{\text{Power (VA)}}{\text{Voltage (V)}}$$

- Three-phase:
$$I_{\max} \text{ (A)} = \frac{\text{Power (VA)}}{\sqrt{3} \cdot \text{Voltage (V)}}$$

Based on the maximum current and voltage and depending on whether it is input or output for the protection, select the current equal to or higher than the one calculated in the table. For the output it is advisable to enter the standardised caliber lower than or equal to the calculated nominal current.

I _{max} (A)	Input protection (A)		Output protection (A)	
	MCB -> D Curve	aM Fuse	MCB -> C Curve	gG Fuse
0.5	1	1	-	0.5
0.6	2	2	-	0.6
0.7	2	2	-	0.7
0.8	2	2	-	0.8
1	2	2	1	1
1.5	3	3	-	1.6
2	4	4	2	2
2.5	6	6	-	2.5
3.5	10	10	3	3
4	10	10	4	4
5	10	10	-	5
6	16	16	6	6.3
7	16	16	-	8
8	16	16	-	8
9	20	20	-	8
10	20	20	10	10
12	25	25	-	12
15	32	32	16	12
20	40	40	20	20
25	50	50	25	25
30	63	63	32	30
40	80	80	40	40
50	100	100	50	50
60	125	125	63	60
80	160	160	80	80
100	200	200	100	100
150	300	300	160	160
200	400	400	200	200
250	500	500	250	250
300	600	600	300	300
400	800	800	400	400
500	1000	1000	500	500
600	1200	1200	600	600
800	1600	1600	800	800
1000	2000	2000	1000	1000
1500	2500	2500	1600	1600

For high currents >100A modular MCBs are recommended with a thermal adjustment of 0.8-1In, to adapt to the nominal current of the transformer.

Example for single-phase transformer:

For a TKW with a power of 10 kVA, input of 230 V and output of 230 V:

$$I_{\max} = \frac{10.000 \text{ VA}}{230 \text{ V}} = 43,47 \text{ A}$$

According to the table the highest I_{max} would be 50 A, so:

- Input protection: MCB 100 A D Curve or 100 A aM Fuse

According to the table the lowest I_{max} would be 40 A, so:

- Output protection: MCB 40 A D Curve or 40 A gG Fuse

Example for a three-phase transformer:

For a TTW with a power of 200 kVA, input of 400 V and output of 400 V:

$$I_{\max} = \frac{200.000}{\sqrt{3} \cdot 400} = 288,67 \text{ A}$$

According to the table the highest I_{max} would be 300 A, so:

- Input protection: MCB 600 A D Curve or 600 A aM Fuse

According to the table the lowest I_{max} would be 250 A, so:

- Output protection: MCB 250 A D Curve or 250 A gG Fuse



Avda. de Roma, 18-26
08290 CERDANYOLA DEL VALLÈS
Barcelona · (Spain)
Tel. +34 93 692 65 65
International tel. +34 93 594 65 41
polylux@polylux.com · export@polylux.com



 **POLYLUX[®]**

www.polylux.com